

TECHNICAL CHARACTERISTICS

	STANDARD	AVAILABLE OPTIONS
Technology	Peristaltic	
Maximum Flow rate at 1 cSt L/h (GPM)	450 (1.98) (1)	
Ports	Nipples	
Dimensions mm (in.)	A	525 (20.7)
	B	325 (12.8)
	C	192.(7.56)
	D	62 (2.44)
	E	405 (15.94)
Weight kg (lbs)	26 - 32 (57 - 70)	

(1) Intermittent duty only.

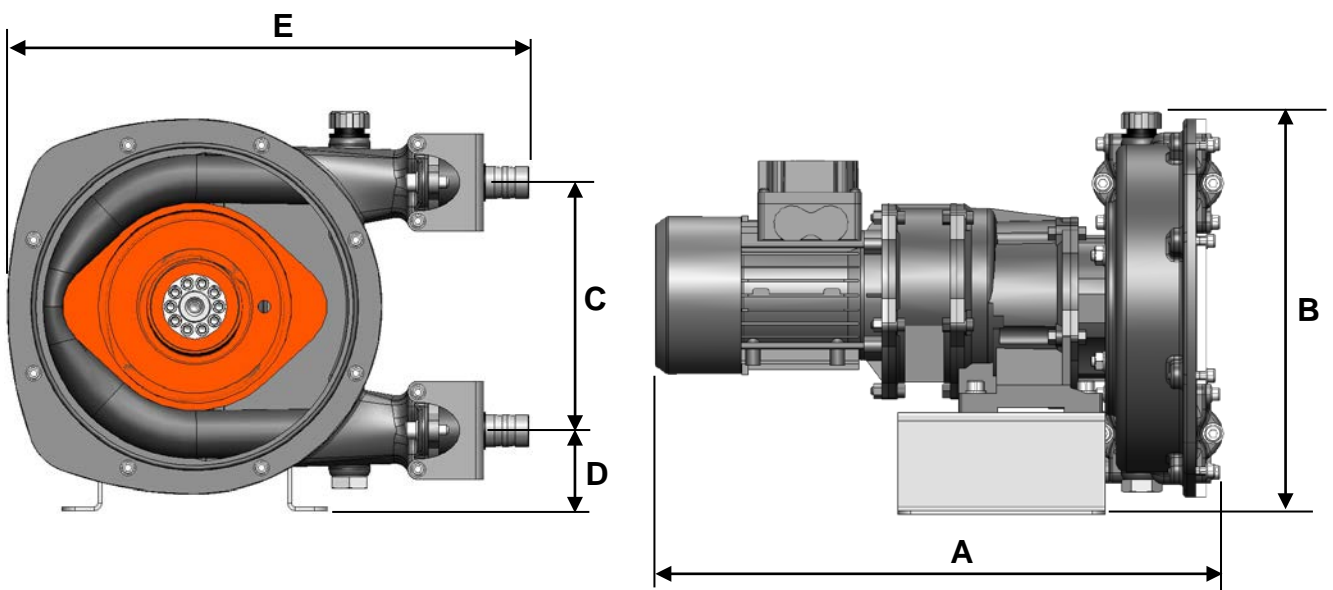

OPERATING LIMITS

	STANDARD MATERIALS	OPTIONAL MATERIALS
Minimum temperature °C (°F)	0 (32)	
Maximum temperature °C (°F)	70 (158)	80 (176) with EPDM hose
Maximum viscosity cSt (SSU)	30000 (139000)	
Maximum differential pressure bar (psi)	8 (116)	
Maximum speed rpm	90 (1)	
Maximum solid particle size mm (in)	3 (0.12)	
Maximum soft particle size mm (in)	5 (0.2)	

(1) Intermittent duty only.

MATERIALS OF CONSTRUCTION

Part No	PART NAME	STANDARD MATERIALS	AVAILABLE OPTIONS
1	Casing	Ductile Iron	
2	Cover	Polycarbonate	
3	Rotor	Ductile Iron	
10	Cover seal	FKM	
26	Shaft seal	FKM	
12	Insert	Stainless steel	PPH, PVDF
16	Hose	NR	NBR, NBR-FDA, EPDM, Hypalon
18	Bracket	Stainless steel	
	Bolts, screws, washers	Stainless steel	

