

# IOM

INSTALLATION OPERATION  
& MAINTENANCE

# F200

2 INCH FDA

AIR-OPERATED DOUBLE-DIAPHRAGM PUMP

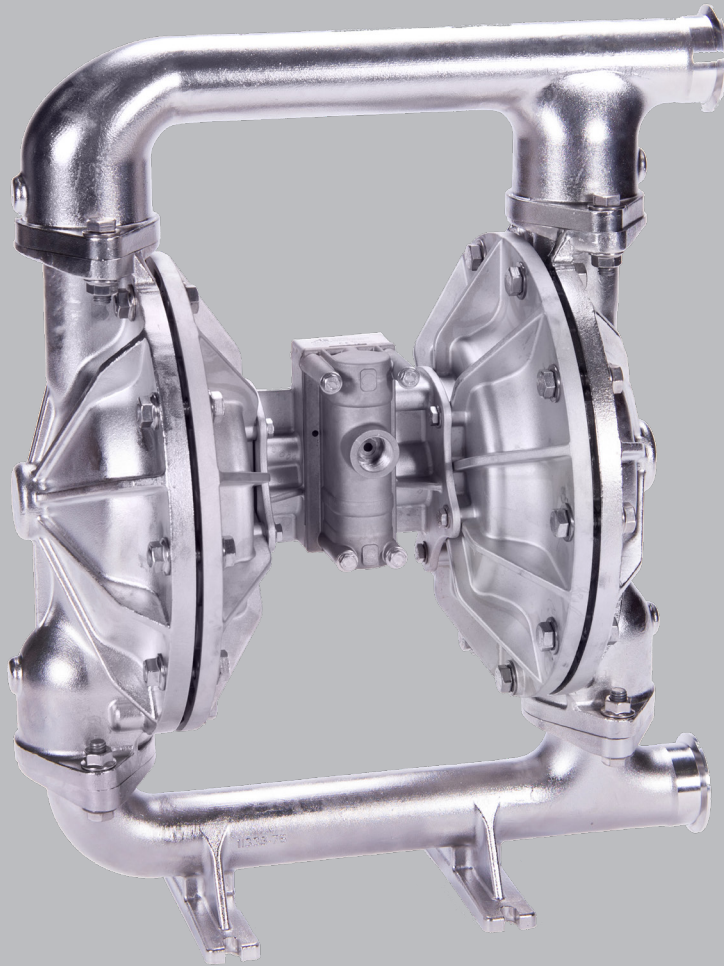

FDA

Ex

CE

**PSG**  
a **DOVER** company

 **ALL-FLO**

# TABLE OF CONTENTS

SECTION 1	WARNINGS, DANGERS AND CAUTIONS	3
SECTION 2	MODEL DESIGNATION MATRIX & REPAIR KITS	4
SECTION 3	PRINCIPLES OF OPERATION	5
SECTION 4	DIMENSIONAL DRAWINGS	6
SECTION 5	PERFORMANCE CURVES	
	RUBBER DIAPHRAGMS .....	7
	TPE DIAPHRAGMS .....	7
	PTFE DIAPHRAGMS.....	7
SECTION 6	INSTALLATION	
	INSTALLATION.....	8-9
	TROUBLESHOOTING.....	10
	OPERATION .....	11
	MAINTENANCE .....	11
SECTION 7	REPAIR AND ASSEMBLY	
	PUMP WET END REMOVAL.....	12-13
	AIR VALVE REMOVAL.....	14-15
	PILOT VALVE REMOVAL .....	16-17
	TORQUE SPECIFICATION CHART.....	17
SECTION 8	EXPLODED VIEW AND PARTS LIST	18-20
SECTION 9	ELASTOMERS	21
SECTION 10	WARRANTY AND REGISTRATION	22

# CAUTIONS — READ FIRST!

READ THESE WARNINGS AND SAFETY PRECAUTIONS PRIOR TO INSTALLATION OR OPERATION. FAILURE TO COMPLY WITH THESE INSTRUCTIONS COULD RESULT IN PERSONAL INJURY AND OR PROPERTY DAMAGE. RETAIN THESE INSTRUCTIONS FOR FUTURE REFERENCE.

**CAUTION** Always wear safety glasses when operating a pump to avoid eye injury. If diaphragm rupture occurs, material being pumped may be forced out of the air exhaust.

**CAUTION** Do not connect a compressed air source to the exhaust port of the pump.

**CAUTION** Do not lubricate air supply.

**CAUTION** Do not exceed 120 psig (8.3 bar) air-inlet pressure.

**CAUTION** Do not exceed 10 psig (0.7 bar) or 23 ft-H<sub>2</sub>O suction pressure.

**CAUTION** The temperature of the process fluid and air input must be no more than the maximum temperature allowed for the appropriate non-metallic material. See the list of temperatures below for each material's maximum recommended temperature:

Buna-N (Nitrile):	10°F to 180°F (-12°C to 82°C)
Geolast®:	10°F to 180°F (-12°C to 82°C)
EPDM:	-40°F to 280°F (-40°C to 138°C)
FKM:	-40°F to 350°F (-40°C to 177°C)
Hytrel®:	-20°F to 220°F (-29°C to 104°C)
Nylon:	0°F to 200°F (-18°C to 93°C)
PTFE:	40°F to 220°F (4°C to 104°C)
Polyethylene:	32°F to 158°F (0°C to 70°C)
Polypropylene:	32°F to 180°F (0°C to 82°C)
Polyurethane:	10°F to 150°F (-12°C to 66°C)
PVDF:	0°F to 250°F (-18°C to 121°C)
Santoprene®:	-40°F to 225°F (-40°C to 107°C)
Urethane:	-65°F to 220°F (-54°C to 104°C)

Temperature limits are solely based upon mechanical stress and certain chemicals will reduce the maximum operating temperature. The allowable temperature range for the process fluid is determined by the materials in contact with the fluid being pumped. Consult a chemical resistance guide for chemical compatibility and a more precise safe temperature limit. Always use minimum air pressure when pumping at elevated temperatures.

**CAUTION** It is the end user's responsibility to maintain the process fluid's temperature during use.

**CAUTION** Ensure all wetted components are chemically compatible with the process fluid and the cleaning fluid.

**WARNING** = Hazards or unsafe practices which could result in severe personal injury, death or substantial property damage

**CAUTION** = Hazards or unsafe practices which could result in minor personal injury, product or property damage.

**WARNING** Prior to servicing the pump, ensure that the air and fluid lines are closed and disconnected. While wearing personal protective equipment, flush, drain and process liquid from the pump in a safe manner.

**WARNING** Maintenance must not be performed when a hazardous atmosphere is present.

**CAUTION** The equipment must be inspected for visible damage prior to use.

**CAUTION** Ensure pump is thoroughly cleaned and flushed prior to installation into a process line.

**CAUTION** Blow out all compressed air lines in order to remove any debris, prior to pump installation. Ensure that the muffler is properly installed prior to pump operation.

**CAUTION** Ensure air exhaust is piped to atmosphere prior to a submerged installation.

**CAUTION** Ensure all hardware is set to correct torque values prior to operation.

**WARNING** Pump, valves and all containers must be properly grounded prior to handling flammable fluids and/or whenever static electricity is a hazard.

**WARNING** The Safety Supplement document is a part of the manual. Please refer to the Safety Supplement document for a complete list of safety considerations including considerations for safe operation and maintenance of pumps marked for ATEX environments before starting the pump.

**WARNING** This product can expose you to chemicals including Nickel, Chromium, Cadmium, or Cobalt, which are known to the State of California to cause cancer and/or birth defects or other reproductive harm. For more information, go to [www.P65Warnings.ca.gov](http://www.P65Warnings.ca.gov).

# MODEL DESIGNATION MATRIX & REPAIR KITS

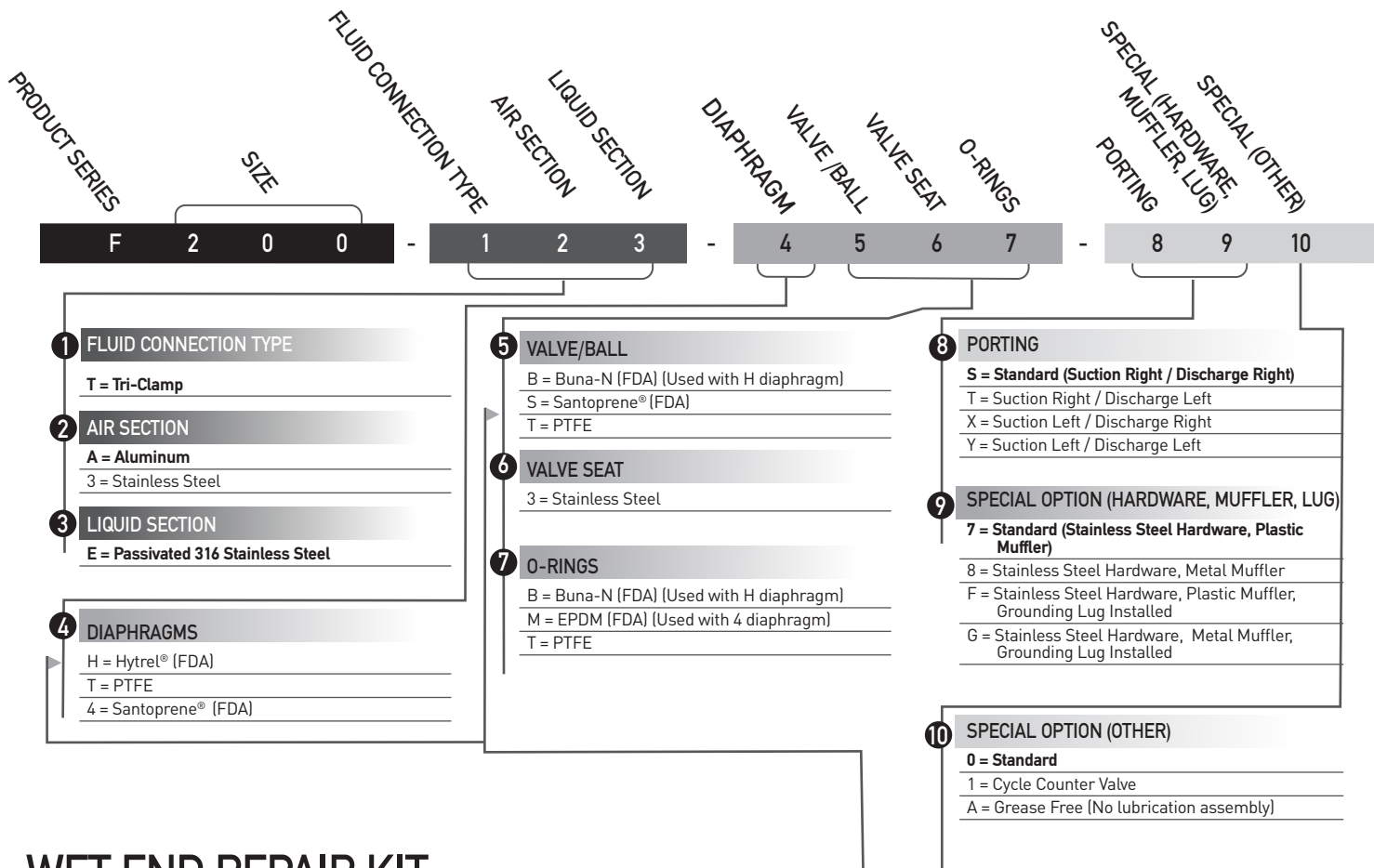

## WET END REPAIR KIT

Wet end kits are available and consist of 2 diaphragms, (back-up diaphragms if required), 4 balls, 4 seats, and 4 seat O-rings. See matrix below.

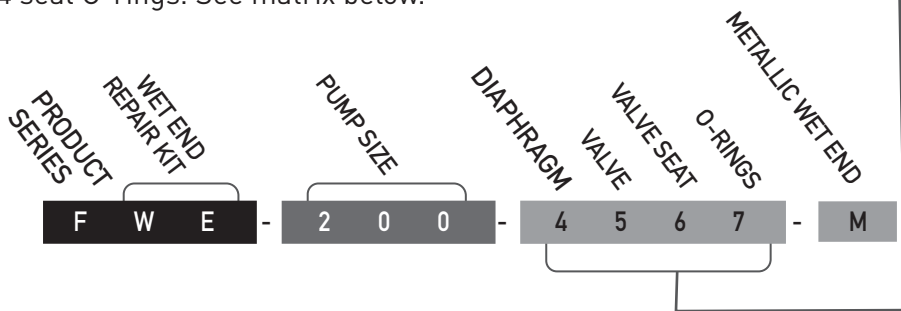

## AIR END REPAIR KIT

Air end repair kit contains pilot sleeve assembly and main air valve.

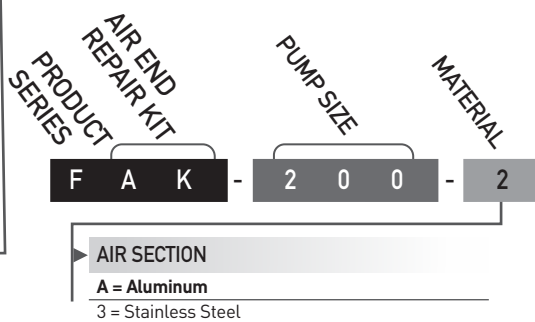

## STANDARD CONFIGURATION PUMP PART NUMBERS

- F200-TAE-TT3T-S70
- F200-TAE-HB3B-S70
- F200-TAE-4S3M-S70

**Bold indicates recommended options**

# PRINCIPLES OF OPERATION

## HOW AN AIR OPERATED DOUBLE DIAPHRAGM PUMP WORKS

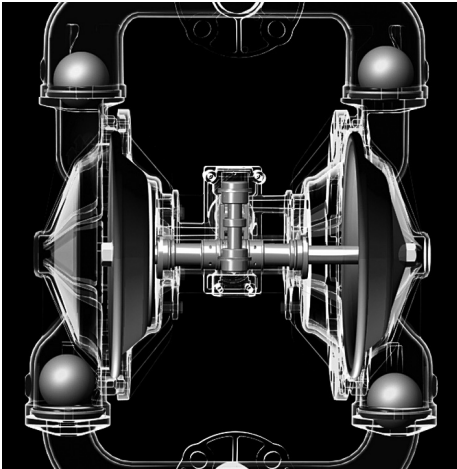

The air-valve directs pressurized air behind the diaphragm on the right, causing the diaphragm on the right to move outward (to the right).

Since both the right diaphragm and the left diaphragm are connected via a diaphragm rod, when the right diaphragm moves to the right, the left diaphragm (through the action of the diaphragm rod) moves to the right also.

When the diaphragm on the left side is moving to the right, it is referred to as suction stroke. When the left diaphragm is in its suction stroke, the left suction ball moves upward (opens) and the left discharge ball moves downward (closes). This action creates suction and draws liquid into the left side chamber.

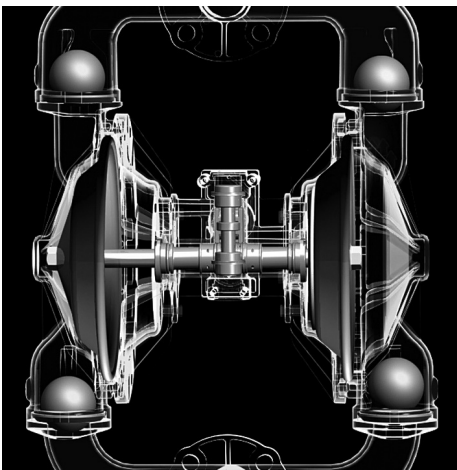

The air-valve directs pressurized air behind the left diaphragm, causing the left diaphragm to move outward (to the left).

Since both the left diaphragm and the right diaphragm are connected via a diaphragm rod, when the left diaphragm moves to the left, the right diaphragm (through the action of the diaphragm rod) moves to the left also.

When the diaphragm on the left side moves outward, the left discharge ball moves upward (opens) and the left suction ball moves downward (closes). This causes the liquid to leave the left side liquid outlet of the pump.

Simultaneously, the right diaphragm moves inward (to the left), which causes the right suction ball to open and the right discharge to close, which in turn causes suction, drawing liquid into the right chamber.

The process of alternating right suction / left discharge (and vice-versa) continues as long as compressed air is supplied to the pump.

# PUMP DIMENSIONS

## F200

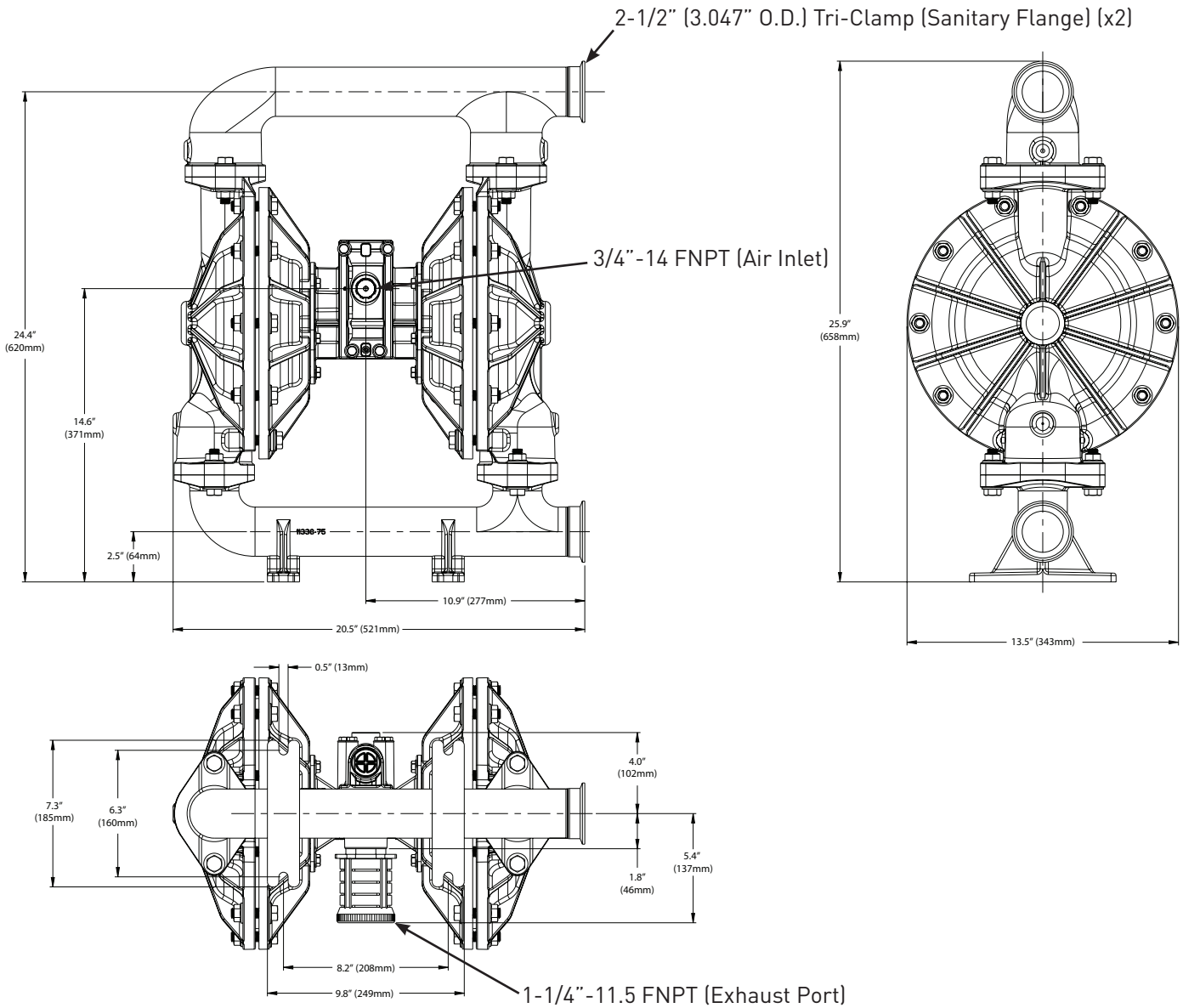

\* Note - Suction / Discharge right are default ports. See part number matrix option code for additional porting options.

\*\*Note: A reducer bushing is included with the standard muffler which reduces the port to 3/4" - 14 FNPT.

# PERFORMANCE CURVES

**PERFORMANCE CURVE (2" RUBBER)\***

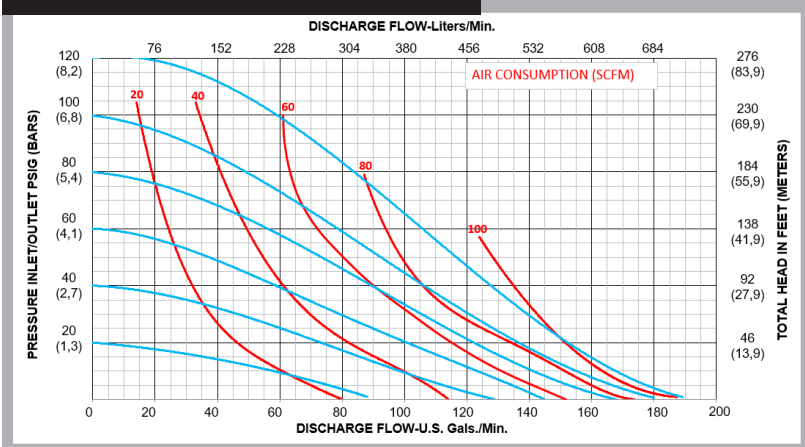

**Performance Specifications**

Max. Flow:	190 gpm (719 lpm)
Max. Air Pressure:	120 psi (8.3 bar)
Max. Solids:	1/4" (6.4 mm)
Max. Suction Lift Dry:	24.4 ft-H <sub>2</sub> O (7.4 m-H <sub>2</sub> O)
Max. Suction Lift Wet:	31.7 ft-H <sub>2</sub> O (9.7 m-H <sub>2</sub> O)
Weight:	115 lbs (52 kg)
Air Inlet:	3/4" FNPT
Liquid Inlet:	2-1/2" Tri-Clamp
Liquid Outlet:	2-1/2" Tri-Clamp
Height:	25.9" (658 mm)
Width:	20.5" (521 mm)
Depth:	13.5" (343 mm)

**PERFORMANCE CURVE (2" TPE)\***

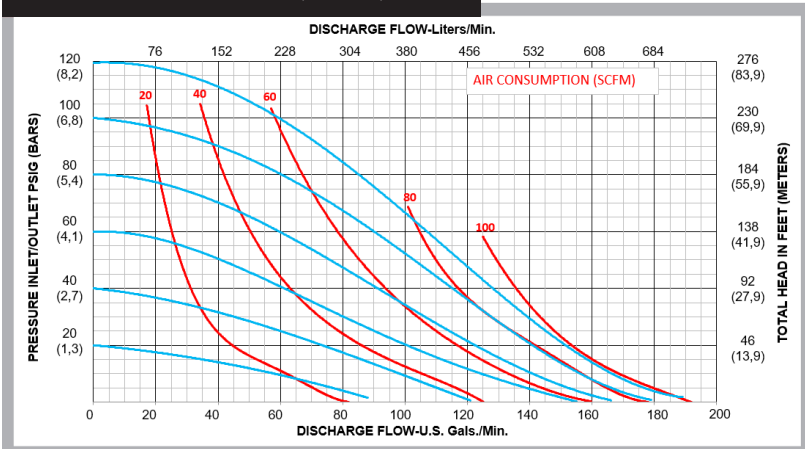

**Performance Specifications**

Max. Flow:	190 gpm (719 lpm)
Max. Air Pressure:	120 psi (8.3 bar)
Max. Solids:	1/4" (6.4 mm)
Max. Suction Lift Dry:	24.4 ft-H <sub>2</sub> O (7.4 m-H <sub>2</sub> O)
Max. Suction Lift Wet:	31.7 ft-H <sub>2</sub> O (9.7 m-H <sub>2</sub> O)
Weight:	115 lbs (52 kg)
Air Inlet:	3/4" FNPT
Liquid Inlet:	2-1/2" Tri-Clamp
Liquid Outlet:	2-1/2" Tri-Clamp
Height:	25.9" (658 mm)
Width:	20.5" (521 mm)
Depth:	13.5" (343 mm)

**PERFORMANCE CURVE (2" PTFE)\***

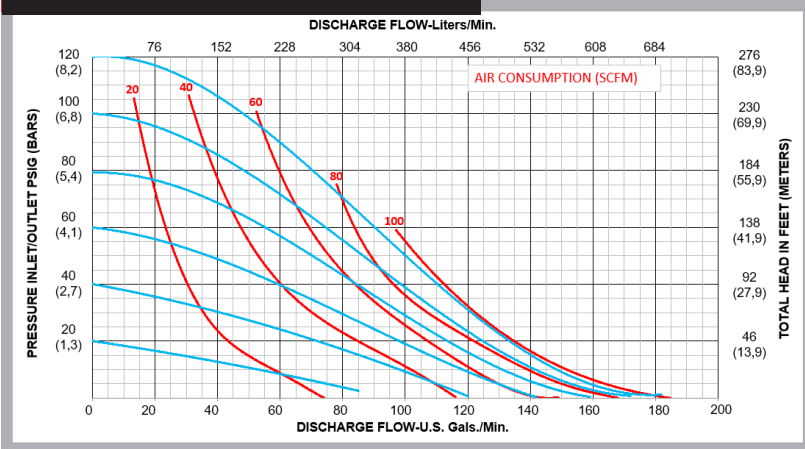

**Performance Specifications**

Max. Flow:	180 gpm (681 lpm)
Max. Air Pressure:	120 psi (8.3 bar)
Max. Solids:	1/4" (6.4 mm)
Max. Suction Lift Dry:	19.3 ft-H <sub>2</sub> O (5.9 m-H <sub>2</sub> O)
Max. Suction Lift Wet:	31.7 ft-H <sub>2</sub> O (9.7 m-H <sub>2</sub> O)
Weight:	115 lbs (52 kg)
Air Inlet:	3/4" FNPT
Liquid Inlet:	2-1/2" Tri-Clamp
Liquid Outlet:	2-1/2" Tri-Clamp
Height:	25.9" (658 mm)
Width:	20.5" (521 mm)
Depth:	13.5" (343 mm)

\*Flow rates indicated on all three charts shown were determined by pumping water at flooded suction. For optimum life and performance, pumps should be specified so that daily operation parameters will fall in the center of the pump performance curve.

# INSTALLATION, TROUBLESHOOTING AND MAINTENANCE

## INSTALLATION PIPING

Whenever possible ensure the pump is installed using the shortest possible pipe lengths with the minimum amount of pipe fittings. Ensure all piping is supported independent of the pump.

Suction and discharge piping should not be smaller than the connection size of the pump. When pumping liquids of high viscosity, larger piping may be used, in order to reduce frictional pipe loss.

Employ flexible hoses in order to eliminate the vibration caused by the pump. Mounting feet can also be used to reduce vibration effects.

All hoses should be reinforced, non-collapsible and be capable of high vacuum service. Ensure that all piping and hoses are chemically compatible with the process and cleaning fluid.

For processes where pulsation effects should be reduced, employ a pulsation dampener on the discharge side of the pump.

For self-priming applications, ensure all connections are airtight and the application is within the pumps dry-lift capability. Refer to product specifications for further details.

For flooded suction applications, install a gate valve on the suction piping in order to facilitate service.

For unattended flooded suction operation, it is recommended to pipe the exhaust air above the liquid source. In the event of a diaphragm failure this will reduce or eliminate the possibility of liquid discharging through the exhaust onto the ground.

## LOCATION

Ensure that the pump is installed in an accessible location, in order to facilitate future service and maintenance.

## AIR

Ensure that the air supply is sufficient for the volume of air required by the pump. Refer to product specifications for further details. For reliable operation, install a 5 micron air filter, air-valve and pressure regulator. Do not exceed the pumps maximum operating pressure of 120 psig.

## REMOTE OPERATION

Utilize a three way solenoid valve for remote operation. This ensures that air between the solenoid and the pump is allowed to “bleed off,” ensuring reliable operation. Liquid transfer volume is estimated by multiplying displacement per stroke times the number of strokes per minute

## NOISE

Correct installation of the muffler reduces sound levels. Refer to product specifications for further details.

## SUBMERGED OPERATION

For submersible operation, pipe the air exhaust to atmosphere

## GROUNDING THE PUMP

Loosen grounding screw and install a grounding wire. Tighten grounding screw. Wire size should be a 12 gauge wire or larger. Connect the other end of the wire to a true earth ground. Equipment must be grounded to achieve ATEX rating and it is recommended to configure the pump with a grounding lug option.





# SUGGESTED INSTALLATION

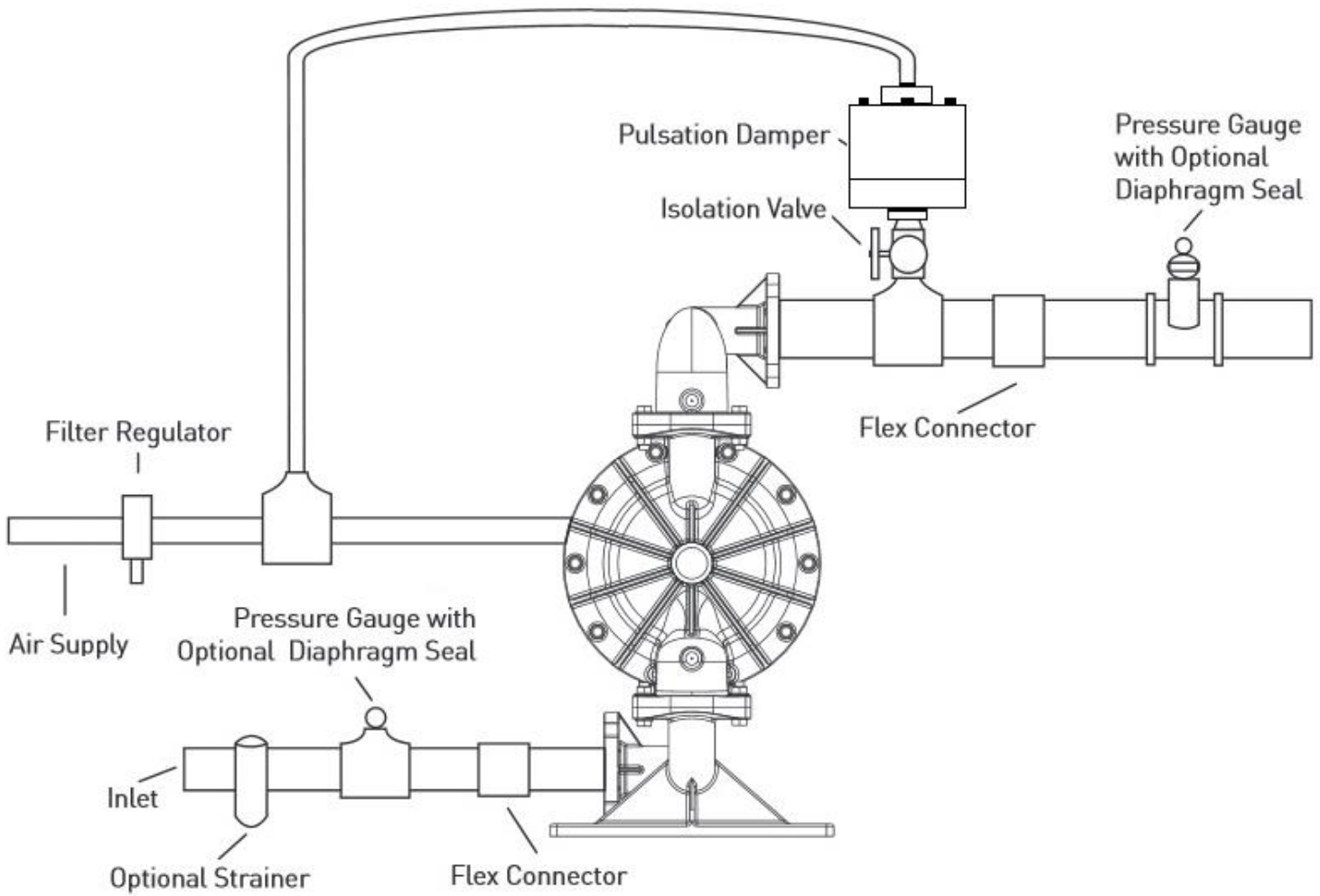

This illustration is a generic representation of an air operated double-diaphragm pump.

# TROUBLESHOOTING

## PROBLEM

## EFFECT/SOLUTION

### Pump Will Not Cycle

Discharge line closed or plugged  
Discharge filter blocked  
Check valve stuck  
Air filter blocked  
Air supply valve closed  
Air supply hooked up to muffler side of pump  
Compressor not producing air or turned off  
Muffler iced or blinded  
Diaphragm ruptured  
Air line in plant air supply lines ruptured  
Air valve wear/debris  
Pilot sleeve wear/debris  
Diaphragm rod broken  
Diaphragm plate loose

### Pumped Fluid Coming Out of Muffler

Diaphragm ruptured  
Diaphragm plate loose  
Inlet liquid pressure excessive (above 10 psig)

### Pump Cycles but no Flow

Inlet strainer clogged  
Suction valve closed  
Suction line plugged  
No liquid in the suction tank  
Suction lift excessive  
Debris stuck in valves  
Excessive wear of check valves  
Air leak on suction side with suction lift

### Pump Cycles with Closed Discharge Valve

Debris stuck in check valve  
Excessive wear of check valves

### Pump Running Slowly/Not Steady

Air compressor undersized  
Leak in air supply  
Air-line, filter regulator or needle valve undersized  
Muffler partially iced or blinded  
Air valve gasket leak or misalignment  
Air valve wear/debris  
Pilot sleeve wear/debris  
Liquid fluid filter blocked  
Pump may be cavitating, reduce speed of operation  
Suction strainer clogged

### Pump Will Not Prime

Air leak in suction pipe  
Air leak in pump manifold connections  
Suction strainer and lines clogged  
Excessive lift conditions  
Check valve wear  
Debris in check valve

## OPERATION

The Air-Operated Double Diaphragm Pump requires a minimum of 20 psig of air to operate, with some variation according to diaphragm material. Increasing the air pressure results in a more rapid cycling of the pump and thus a higher liquid flow rate. In order to not exceed 120 psig of inlet air pressure, and for accurate control of the pump, it is suggested to use a pressure regulator on the air inlet.

An alternate means of controlling the flow-rate of the pump is to use an inlet air valve and partially open or close accordingly. When the air valve is completely in the closed position, the pump will cease to operate.

A third method of controlling the flow rate of the pump is to use a liquid discharge valve. Closing the liquid discharge valve will cause a decrease in the flow rate since the pump will operate against a higher discharge pressure.

Solenoid control of the inlet air may also be used in order to facilitate remote operation. A three way solenoid valve is recommended, in order to allow the air to “bleed off” between the solenoid and the pump.

Do not use valves for flow control on the suction side of the pump. (Closing or partially closing a liquid suction valve restrict the suction line and may cause damage to the diaphragms.) Suction strainers may be employed to reduce or eliminate larger solids, but routine maintenance is necessary in order to prevent a restriction on the suction.

## MAINTENANCE

Due to the unique nature of each application, periodic inspection of the pump is the best method to determine a proper maintenance schedule. A record should be kept of all repairs made to an installed pump. This will serve as the best predictor of future maintenance.

Typical maintenance involves replacing of “wear-parts” such as the diaphragms, balls, valve seats and O-rings. Proper maintenance can ensure trouble-free operation of the pump. Refer to repair and assembly instructions for further details.

 **WARNING** Maintenance must not be performed when a hazardous atmosphere is present.

## MAINTENANCE SCHEDULE

### WEEKLY (OR DAILY)

Make a visual check of the pump. If pumped fluid is leaking out of the pump, pipe fittings or muffler turn off pump and schedule maintenance.

### EVERY THREE MONTHS

Inspect fasteners and tighten any loose fasteners to recommended torque settings.

Schedule pump service based on pump’s service history.

# REPAIR AND ASSEMBLY

## PUMP WET END REMOVAL

### TOOLS NEEDED

- 1) One Wrench, 7/16 Inch
- 2) Two Wrenches, 1/2 Inch
- 3) Two Wrenches, 3/4 Inch
- 4) Two Wrenches, 1 Inch
- 5) One Socket Wrench, 1-1/16 Inch
- 6) One Spanner Wrench, 3/4 Inch (May Be Required)

**⚠ WARNING** Prior to servicing the pump, ensure that the air and fluid lines are closed and disconnected. While wearing personal protective equipment, flush, drain and process liquid from the pump in a safe manner.

**⚠ WARNING** Maintenance must not be performed when a hazardous atmosphere is present.

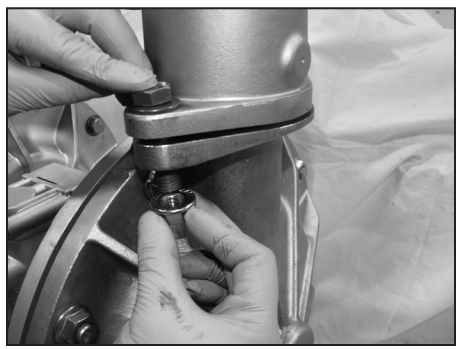

#### STEP 1

Using the 3/4 inch wrench remove four "Hex-Head Cap Screws (1/2"-13x2-1/4")", four "Flat and Lock Washers (1/2")" and four "Flanged Hex Nuts (1/2"-13)" from the "Discharge Manifold".

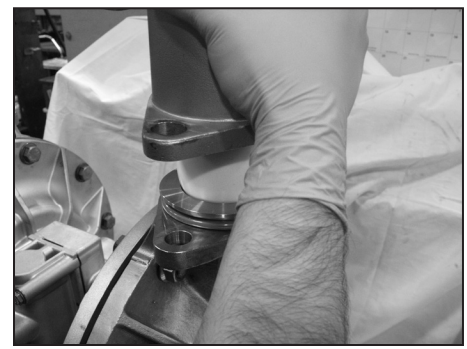

#### STEP 2

Remove the "Discharge Manifold".

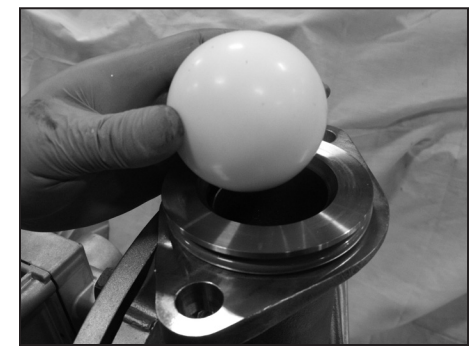

#### STEP 3

Remove the "O-Ring", "Valve Seat" and "Ball".



#### STEP 4

Using the 3/4 inch wrench remove four "Hex-Head Cap Screws (1/2"-13x2-1/4")", four "Flat and Lock Washers (1/2")" and four "Flanged Hex Nuts (1/2"-13)" from the "Suction Manifold".



#### STEP 5

Remove the "Suction Manifold".



#### STEP 6

Remove the "O-Ring", "Valve Seat" and "Ball".



### STEP 7

In order to remove both “Outer Chambers” use two ¾ Inch wrenches. Remove ten “Hex-Head Cap Screws (1/2”-13x2-1/4”)”, ten “Flat and Lock Washers (1/2”)” and eight “Flanged Hex Nuts (1/2”-13)” from each “Outer Chamber”. (Air ratchet may also be used as shown in image)



### STEP 8

Remove both “Outer Chambers” from the “Intermediate.”



### STEP 9

Using two 1 Inch wrenches, remove “Outer Diaphragm Plate”, “Diaphragm”, “Inner Diaphragm Plate” and “Nut” from one side of the pump.



### STEP 10

Placing the 1 inch wrench on the “Outer Diaphragm Plate”, and the 1 1/16 inch socket on the “Nut”, remove the “Inner Diaphragm Plate”.

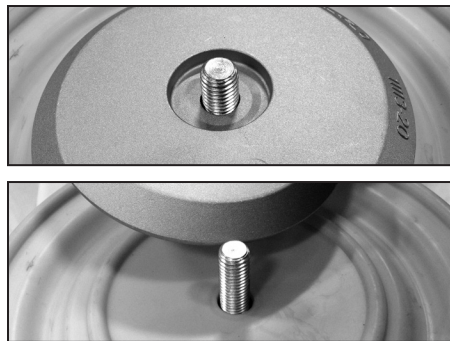

### STEP 11

Remove “inner diaphragm plate” and “outer diaphragm plate” from “diaphragm.”

## PUMP WET END ASSEMBLY

To assemble the wet end of the pump, reverse the order of disassembly. Ensure all hardware is fastened in accordance with torque specifications [see page 18]. Inverting one of the diaphragms during reassembly will facilitate ease of assembly.

# REPAIR AND ASSEMBLY

## AIR VALVE REMOVAL

### TOOLS NEEDED

- 1) One Wrench, 7/16 Inch
- 2) One Pick, General Purpose
- 3) One Pair of Pliers

**⚠ WARNING** Prior to servicing the pump, ensure that the air and fluid lines are closed and disconnected. While wearing personal protective equipment, flush, drain and process liquid from the pump in a safe manner.

**⚠ WARNING** Maintenance must not be performed when a hazardous atmosphere is present.



#### STEP 1

Using the  $\frac{7}{16}$  inch wrench, remove four "Hex Head Cap Screws (1/4"-20 x 3")", four "lock washers (1/4)" and four "flat washers (1/4)".

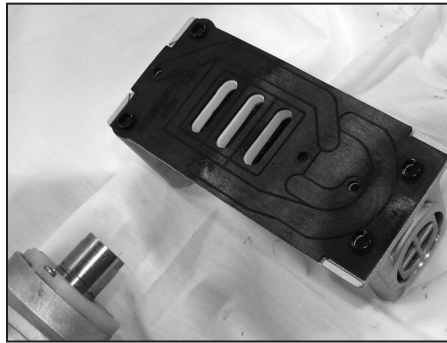

#### STEP 2

Remove the main "Air-Valve Assembly" from the pump.

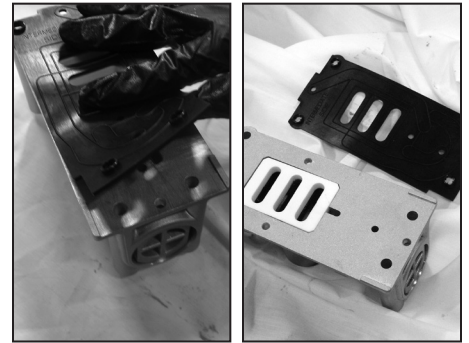

#### STEP 3

Remove the "Air-Valve Gasket" from the main "Air-Valve Assembly".

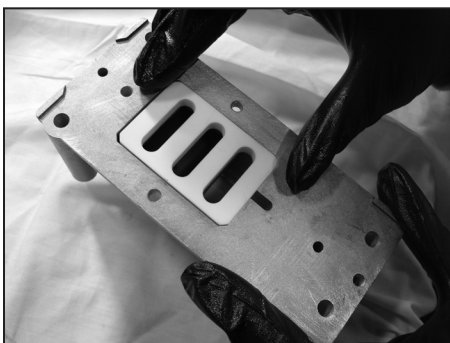

#### STEP 4

Remove the "Shuttle Plate" from the main "Air-Valve Assembly".

Note: The smooth shiny side of the shuttle plate should be toward the shuttle car.



#### STEP 5

Remove the "Shuttle" from the main "Air-Valve Assembly".



#### STEP 6

Using the pair of pliers, remove the "Air Valve End Plug" from the main "Air-Valve Assembly".

Ensure the "O-Ring" is installed when reassembling.



### STEP 7

Remove the "Air Valve Spool" from the main "Air-Valve Assembly".

Note: The longer piston is to be on the plug side.

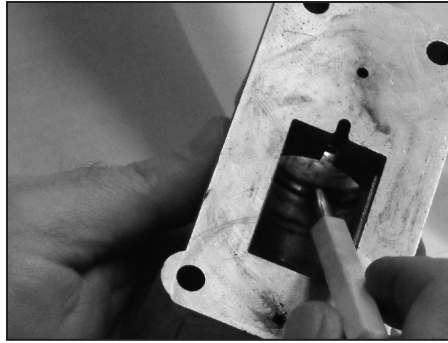

### STEP 8

Using the pick, remove the "Lip Seal (Air Valve)" from the main "Air-Valve Assembly".

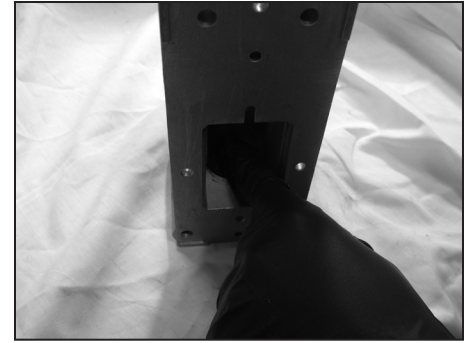

### STEP 9

Using the pick, remove the second "Lip Seal (Air Valve)" from the main "Air-Valve Assembly".

## AIR VALVE ASSEMBLY

To assemble the air valve, reverse the order of disassembly. During assembly, ensure that the open side of the lip-seals are both facing each other inward. Install the shuttle plate with the smooth/shiny side toward the shuttle car. Lubrication of the air valve assembly, with a non-synthetic lubricant is recommended. Magna-Lube or Magna-Plate are recommended for assembly lubrication (see detailed parts list for ordering information).

Note that if the lip-seals are installed incorrectly, they will be unable to rotate. Insert the spool, the spool's longer piston is to be on the plug side and then the air-valve end plug into position.

# REPAIR AND ASSEMBLY

## PILOT VALVE REMOVAL

### TOOLS NEEDED

- 1) One Screwdriver, Phillips #2
- 2) Two Wrenches, 3/4 Inch

The chambers do not need to be removed for this procedure.

The graphics show the inner chambers removed for clarity.

**⚠ WARNING** Prior to servicing the pump, ensure that the air and fluid lines are closed and disconnected. While wearing personal protective equipment, flush, drain and process liquid from the pump in a safe manner.

**⚠ WARNING** Maintenance must not be performed when a hazardous atmosphere is present.



#### STEP 1

Using the screwdriver, remove three "Phillips Pan Head Mach Screw (#6-32-x 3/8")" in order to remove the "Retaining Plate". Repeat for both sides of the pump.

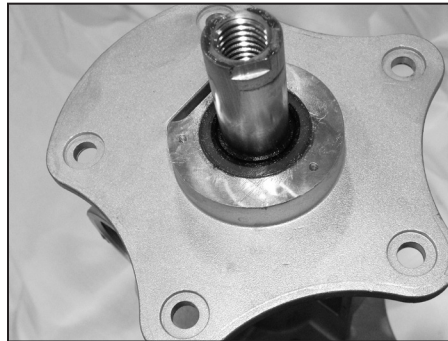

#### STEP 2

Remove the "diaphragm rod" and the "pilot sleeve assembly" from the "Intermediate".



#### STEP 3

Remove the "lip seal" and "end spacer".



#### STEP 4

Remove "O-rings" and "inner spacer".

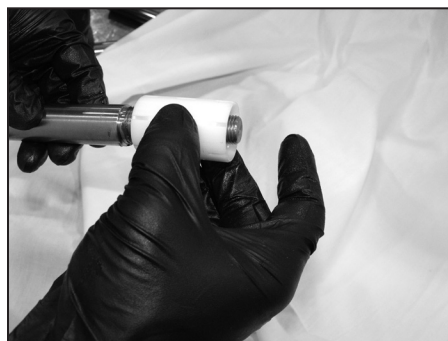

#### STEP 5

Remove "pilot sleeve" from diaphragm rod. The two piece rod must be disassembled to remove the "pilot sleeve". Use the 3/4 inch wrenches to separate the rod. Note they are installed with threadlocker.



# PILOT VALVE ASSEMBLY

To assemble the pilot valve, reverse the order of disassembly. Should process fluid have contact with the pilot valve o-rings, they should be replaced as swelling may occur and cause irregular operation. During assembly, ensure that the open side of the lip-seals are facing outward. Lubrication of the pilot sleeve assembly, with a non-synthetic lubricant, is recommended in order to facilitate re-assembly into the intermediate. Magna-Lube or Magna-Plate are recommended for assembly lubrication (see detailed parts list for ordering information).

## TORQUE SPECIFICATION CHART

### RECOMMENDED TORQUE SPECIFICATIONS

	2" Pumps	Wrench Size
Manifold Bolts	37 ft-lbs (50.2 N-m)	3/4"
Chamber Bolts	15 ft-lbs (20.3 N-m)	3/4"
Air Valve Bolts	40 in-lbs (4.5 N-m)	7/16"
Inner Diaphragm Plate Nut	50 ft-lbs (67.8 N-m)	1 1/16"
Intermediate Bolts	11 ft-lbs (14.9 N-m)	1/2"
Outer Diaphragm Plate	Hand tight then 1/8 to 1/4 turn more	

# EXPLODED VIEW & PARTS LIST

F200-TAE-\*\*\*\*-\*\*\*

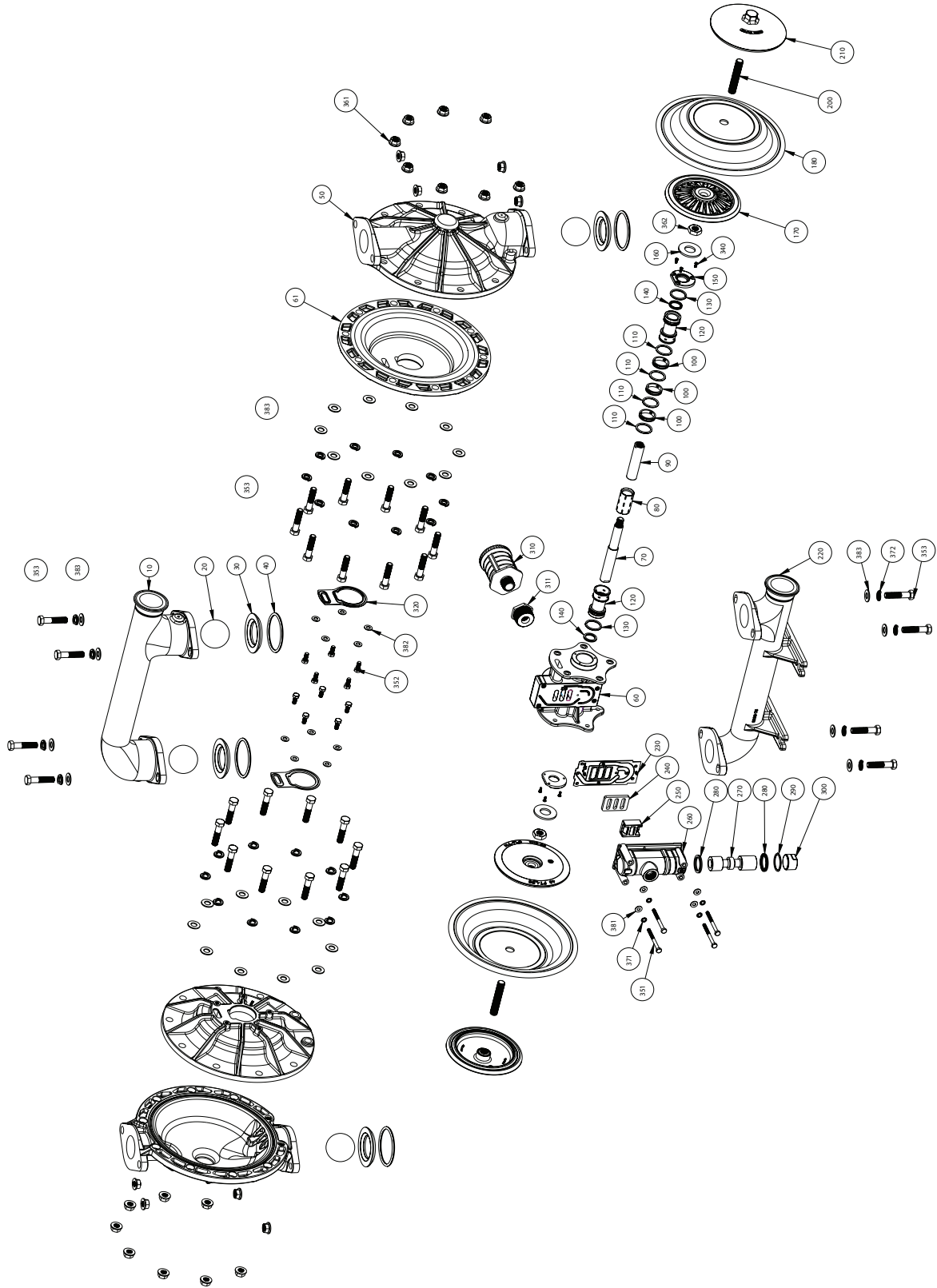

# PARTS LIST - F200-T\*E-\*\*\*\*\_\*\*\*

ITEM	DESCRIPTION	QTY	PUMP MODEL	PART NO.	MATERIAL
10	DISCHARGE MANIFOLD - (TRI-CLAMP)	1	All Models	10560-75	Stainless Steel
20	BALL	4	F200-T*E-*B**_*** F200-T*E-*S**_*** F200-T*E-*T**_***	11009-14 11009-23 11009-45	Buna-N (FDA) Santoprene® (FDA) PTFE
30	VALVE SEAT	4	F200-T*E-***3_***	10925-26	Stainless Steel
40	O-RING, VALVE SEAT	4	F200-T*E-***B-*** F200-T*E-***T-*** F200-T*E-***M-***	11917-14 11917-17 11917-81	Buna-N (FDA) PTFE EPDM (FDA)
50	OUTER CHAMBER	2	All Models	10725-75	Stainless Steel
60	INTERMEDIATE	1	F200-TAE-****_*** F200-T3E-****_***	11525-20 11525-26	Aluminum Stainless Steel
61	INNER CHAMBER	2	F200-TAE-****_*** F200-T3E-****_***	11805-20 11805-26	Aluminum Stainless Steel
70 & 90	DIAPHRAGM ROD ASSEMBLY	1	All Models	35002-00	Stainless Steel
80	PILOT VALVE	1	All Models	10107-31 Δ	Acetal
100	INNER SPACER, PILOT SLEEVE	3	All Models	10205-40 Δ	Polypropylene
110	O-RING (PILOT SLEEVE SPACER)	4	All Models	11919-16 Δ	Urethane
120	END SPACER, PILOT SLEEVE	2	All Models	10208-40 Δ	Polypropylene
130	O-RING (END SPACER)	2	All Models	11919-11 Δ	Nitrile
140	LIP SEAL (DIAPHRAGM ROD)	2	All Models	12002-76 Δ	Nitrile
150	RETAINING PLATE	2	All Models	12717-54	Nylon
160	BUMPER	2	All Models	12317-16	Urethane
170	INNER DIAPHRAGM PLATE	2	F200-TAE-****_*** F200-T3E-****_***	11113-20 11113-26	Aluminum Stainless Steel
180	DIAPHRAGM (BACKUP)	2	F200-T*E-H***_*** F200-T*E-4***_*** F200-T*3-T***_*** (B-UP)	10611-18 10611-80 10611-80	Hytrell Santoprene® (FDA) Santoprene® (FDA)
190	OVERLAY (DIAPHRAGM)	2	F200-T*3-T***_*** ONLY	11408-59	PTFE
200&210	OUTER DIAPHRAGM PLATE W/THREADED STUD	2	F200-T*E-****_***	11218-73	Stainless Steel
220	SUCTION MANIFOLD - (TRI-CLAMP)	1	All Models	11338-75	Stainless Steel
230	GASKET, AIR VALVE	1	All Models	12124-19 ‡	Nitrile
240	SHUTTLE PLATE	1	All Models	10450-77 ‡	Ceramic
250	SHUTTLE	1	All Models	10430-00 ‡	Special
260	AIR VALVE BODY	1	F200-TAE-****_*** F200-T3E-****_***	11618-20 ‡ 11618-26 ‡	Aluminum Stainless Steel
270	AIR VALVE SPOOL	1	All Models	10483-31 ‡	Acetal
280	LIP SEAL (AIR VALVE)	2	All Models	12003-76 ‡	Nitrile
290	O-RING (AIR VALVE END PLUG)	1	All Models	11913-11 ‡	Nitrile
300	AIR VALVE END PLUG	1	F200-TAE-****_*** F200-T3E-****_***	11706-20 ‡ 11706-26 ‡	Aluminum Stainless Steel
310&311	MUFFLER w/ BUSHING	1	Standard Optional	13013-00 13010-00	Polypropylene Metal
320	INNER CHAMBER GASKET	2	All Models	12123-19	Nitrile
330	N/A				
340	SELF-LOCKING PHILLIPS SCREW, (#6-32 X 3/8")	6	All Models	12571-26	Stainless Steel

# PARTS LIST - F200-T\*E-\*\*\*\*-\*\*\*

ITEM	DESCRIPTION	QTY	PUMP MODEL	PART NO.	MATERIAL
351	CAP SCREW, (1/4"-20 X 3")	4	All Models	12516-26	Stainless Steel
352	CAP SCREW, (5/16"-18 X 3/4")	10	All Models	12536-26	Stainless Steel
353	CAP SCREW, FLANGED, (1/2"-13 x 2-1/4")	28	All Models	12572-225-26	Stainless Steel
361	NUT, FLANGE (1/2"-13)	24	All Models	12582-26	Stainless Steel
362	NUT, (5/8"-11)	2	All Models	12579-25	Plated Steel
370	N/A				
381	WASHER, LOCK STAR (1/4")	4	All Models	12350-26	Stainless Steel
382	WASHER, FLAT (1/4")	4	All Models	12300-26	Stainless Steel
383	WASHER, FLAT (5/16")	10	All Models	12310-26	Stainless Steel
384	WASHER, LOCK SPLIT (1/2")	28	All Models	12323-26	Stainless Steel
385	WASHER, FLAT (1/2")	28	All Models	12306-26	Stainless Steel
390	N/A				
400	N/A				
	Magnalube® .75 oz. (As Required)		ALL MODELS	13404-00	Grease

\* Any Character

‡ , Δ Only sold as part of assembly

ASSEMBLY PART NUMBERS	PUMP MODEL	PART NO.	MATERIAL
‡ PILOT VALVE ASSEMBLY 230, 240, 250, 260, 270, 280, 290, 300	All Models	FPK-200-A	Various
PILOT SLEEVE ELASTOMER KIT 100 THROUGH 140	All Models	PEK-35003	Various
Δ MAIN AIR VALVE ASSEMBLY 80, 100, 110, 120, 130, 140	All Models	FMK-200-A	Various

# ELASTOMERS

## WETTED ELASTOMERS

### BUNA-N (NITRILE)

is a general purpose elastomer used with water and many oils. Temperature range 10°F to 180°F (-12°C to 82°C).

---

### EPDM

is a general purpose elastomer with good resistance to many acids and bases. Temperature range -40°F to 280°F (-40°C to 138°C).

---

### FKM

is an elastomer with good corrosion resistance to a wide variety of chemicals. Temperature range -40°F to 350°F (-40°C to 177°C).

---

Most of the above elastomers are available in FDA approved formulations.

Geolast® is a registered trademark of ExxonMobil Chemical Co.  
Santoprene® is a registered trademark of ExxonMobil Chemical Co.  
Hytrel® is a registered trademark of DuPont Performance Elastomers L.L.C.  
Magnalube® is a registered trademark of Carleton-Stuart Corp.

### GEOLAST®

is an injection molded thermoplastic material with characteristics similar to Nitrile. Has excellent abrasion resistance. Temperature range 10°F to 180°F (-12°C to 82°C).

---

### SANTOPRENE®

is an injection molded material with characteristics similar to EPDM. Has excellent abrasion resistance. Temperature range -40°F to 225°F (-40°C to 107°C).

---

### PTFE (POLYTETRAFLUOROETHYLENE)

is a thermoplastic polymer that is inert to most chemicals. Temperature range 40°F to 220°F (4°C to 104°C).

---

# WARRANTY AND REGISTRATION

WARRANTY. All All-Flo products shall be covered by the standard All-Flo Limited Warranty in effect at the time of shipment. This warranty (which may be modified by All-Flo at any time) provides:

MATERIALS SOLD ARE WARRANTED TO THE ORIGINAL USER AGAINST DEFECTS IN WORKMANSHIP OR MATERIALS UNDER NORMAL USE (RENTAL USE EXCLUDED) FOR FIVE YEARS AFTER PURCHASE DATE. ANY PUMP WHICH IS DETERMINED TO BE DEFECTIVE IN MATERIAL AND WORKMANSHIP AND RETURNED TO ALL-FLO, SHIPPING COSTS PREPAID, WILL BE REPAIRED OR REPLACED AT ALL-FLO'S OPTION. CUSTOMER SHALL NOTIFY ALL-FLO IN WRITING WITHIN 30 DAYS OF ANY CLAIMED DEFECTS. NO MATERIALS CAN BE RETURNED WITHOUT THE PRIOR CONSENT OF ALL-FLO, AND IF APPROVED SHALL BE RETURNED TO ALL-FLO FREIGHT PREPAID. ALL-FLO'S LIABILITY FOR ANY BREACH OF THIS WARRANTY SHALL BE LIMITED TO EITHER REPLACEMENT OF THE MATERIALS OR, AT ALL-FLO'S SOLE OPTION, THE REFUND OF THE PURCHASE PRICE. ALL-FLO SHALL NOT BE HELD LIABLE FOR ANY INCIDENTAL OR CONSEQUENTIAL DAMAGES CAUSED BY BREACH OF THIS WARRANTY. THIS EXCLUSION APPLIES WHETHER SUCH DAMAGES WERE SOUGHT BASED ON BREACH OF WARRANTY, BREACH OF CONTRACT, NEGLIGENCE, STRICT LIABILITY IN TORT, OR ANY OTHER LEGAL THEORY. FURTHER, ALL-FLO SHALL NOT BE LIABLE FOR LOSSES, DELAYS, LABOR COSTS, OR ANY OTHER COST OR EXPENSE DIRECTLY OR INDIRECTLY ARISING FROM THE USE OF MATERIALS. ALL-FLO'S LIABILITY IS EXPRESSLY LIMITED TO THE REPLACEMENT OR REPAIR OF DEFECTIVE GOODS, OR THE TOTAL VALUE OF SUCH GOODS. THIS WARRANTY IS IN LIEU OF ALL OTHER WARRANTIES, WHETHER EXPRESS, IMPLIED, OR ORAL INCLUDING THE IMPLIED WARRANTY OF MERCHANTABILITY, ANY IMPLIED WARRANTY OF FITNESS FOR A PARTICULAR PURPOSE, AND ANY IMPLIED WARRANTIES OTHERWISE ARISING FROM A COURSE OF DEALING OR TRADE. All-Flo will not, in ANY event, be liable for any loss of profit, interruption of business or any other special, consequential or incidental damages suffered or sustained by Customer. All-Flo's total maximum liability to the customer in respect of sale of materials or services rendered by All-Flo is limited to the total monies received by All-Flo from the customer for the particular materials described in Customer's order.

All-Flo does not warrant any part or component that it does not manufacture, but will assign to the original end-user purchaser of any warranty received by it from the manufacturer, to extent such pass through is permitted by the manufacturer

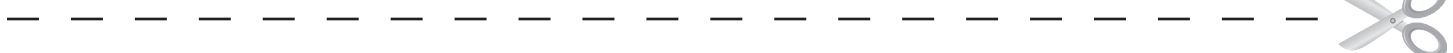

## REGISTRATION FORM

Pump Model \_\_\_\_\_ Pump Serial Number \_\_\_\_\_

Company Name \_\_\_\_\_

Name \_\_\_\_\_ Email \_\_\_\_\_

Phone # \_\_\_\_\_ City \_\_\_\_\_ State \_\_\_\_\_ Zip \_\_\_\_\_

Qty of Pumps \_\_\_\_\_ Fluid Pumping \_\_\_\_\_

How did you hear about us? Existing All-Flo user,  
Web, Distributor, Magazine...

\_\_\_\_\_

**MAIL TO:** All-Flo | Attn: Product Registration  
22069 Van Buren Street, Grand Terrace, CA 92313-5651



Scan QR code and complete form on mobile phone or visit

[www.all-flo.com/registration-form.html](http://www.all-flo.com/registration-form.html)



PSG

22069 Van Buren Street

Grand Terrace, CA 92313-5651 USA

P: +1 (440) 354-1700 F: +1 (440) 354-9466

[all-flo.com](http://all-flo.com)

All-Flo is committed to the pursuit of designing and manufacturing the highest quality product available to industry. Since the beginning in 1986, All-Flo engineers have used their extensive knowledge of today's engineered materials, advanced air system logic and manufacturing techniques to develop the superior group of lube-free, air-operated diaphragm pumps found in this catalog. Every pump is performance engineered and quality built to provide trouble-free service under the toughest conditions.



Where Innovation Flows