

Centrifugal Pumps

HEAVY-DUTY LARGE VOLUME PUMPS | TECHNICAL REFERENCE CATALOG

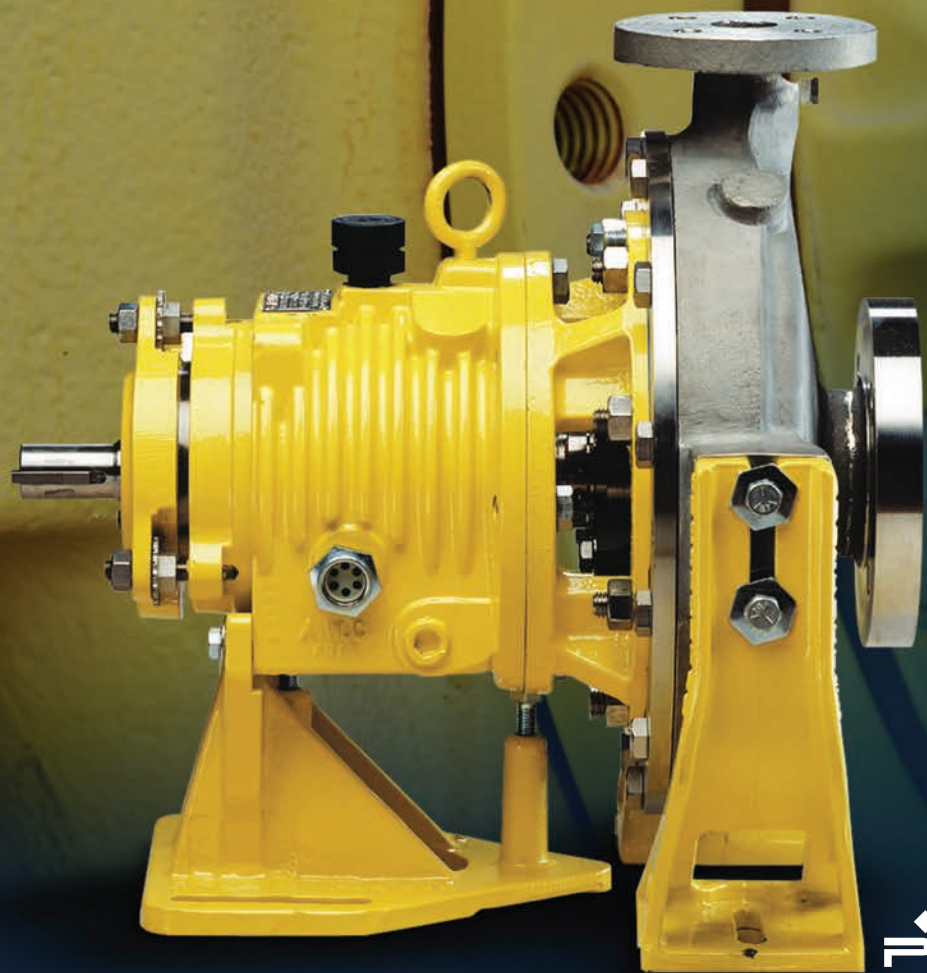

Where Innovation Flows



Centrifugal Pump Catalog Index

	Page
Centrifugal Pumps - Advantages	3-9
Centrifugal Pumps - Product line	11

Frame S/SD Group I (ANSI/ASME/Metric)

Dimensions	11
Design Data	12
Pump Assembly and Parts List, Horizontal 6"/8"	13-14
Auxiliary Pipe Connections	15
Composite Pump Curves:	16
60 cycle	16-27
50 cycle	28-45

Frame LD17 and A Group II (ANSI/ASME/Metric)

Dimensions	46
Design Data	47-48
Pump Assembly and Parts List	49
Auxiliary Pipe Connections	50
Composite Pump Curves:	51
60 cycle	51-81
50 cycle	82-112

Frame M Group III (ASME/ANSI/Metric)

Dimensions	113
Design Data	114
Pump Assembly and Parts List	115
Auxiliary Pipe Connections	116
Composite Pump Curves:	117
60 cycle	117-125
50 cycle	126-132

Centrifugal Pump Accessories

Baseplates	136
Accessories	137-138
SpiralTrac ¹ Bushings – Advantages	139

Engineering Data

Interchangeability	140
Centrifugal Pump Pressure/Temperature Limits	141-144
Pump Dimensions for Mechanical Seal Installation	145

General Pump Specification

Centrifugal Pump Specification for Horizontal End Suction Pumps	146-150
Warranty Information	151

¹ SpiralTrac is a registered trademark of the manufacturer, EnviroSeal Engineering Products Ltd., Waverly, Nova Scotia



Blackmer Centrifugal Pumps stand alone in the crowded centrifugal space. Why? Because our Centrifugal Pumps are **ANSI PLUS** pumps. That means that they are ANSI pumps that comply with key parts of the API 610 standard, bringing a full set of reliability and ease-of-use features not found in any other ANSI pump.

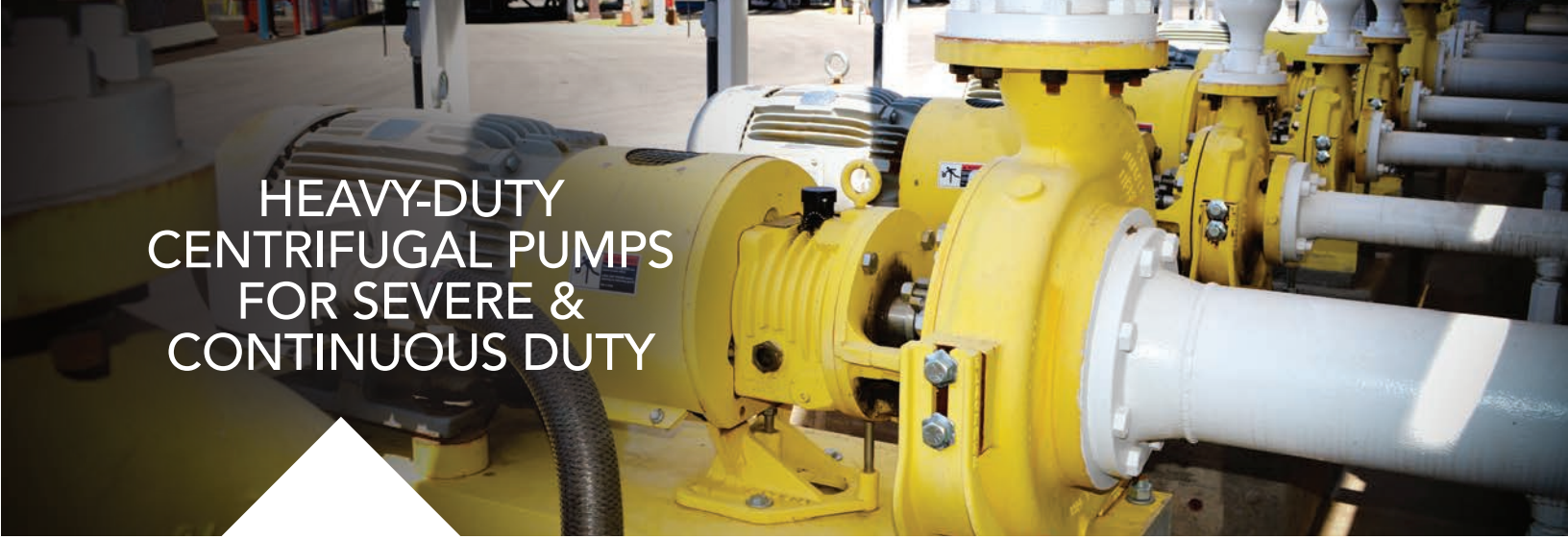

HEAVY-DUTY
CENTRIFUGAL PUMPS
FOR SEVERE &
CONTINUOUS DUTY

Blackmer® Centrifugal Pumps

Designed and built to exacting standards, Blackmer Centrifugal Pumps are highly reliable and perform exceptionally well in safely transferring critical and valuable fluids in the harshest of service conditions. Blackmer guarantees our Centrifugal Pumps with our unmatched performance assurance guarantee – five years for the power end and one year for the mechanical seal.

Blackmer is confident in offering these performance assurance guarantees because our Centrifugal Pumps are designed and constructed to meet the API 610 standard of a minimum 20-year service life and three years of uninterrupted operation. With this standard applied, Blackmer Centrifugal Pumps were overbuilt to protect and support the mechanical seal. This is achieved by providing the stiffest solid shaft on the market, oversized bearings, and numerous other features that protect the pump in even the most aggressive operating conditions. By offering maximum reliability, uptime and extended pump life, Blackmer Centrifugal Pumps are the pumps to turn to when all others fail.

Designed for full curve operation, Blackmer Centrifugal Pumps offer the widest window of operations off the Best Efficiency Point (BEP) of any conventional centrifugal pump. With flow rates up to 4,500 gpm (17,034 L/min) and a standard temperature range of -40° to 400°F (-40° to 204° C), our Centrifugal Pumps can withstand severe and continuous operating conditions, where uptime is vital for operations with factory consultation.



Blackmer® Centrifugal Pumps Key Differentiators

Wider Window of Operation Off the BEP (Best Efficiency Point)

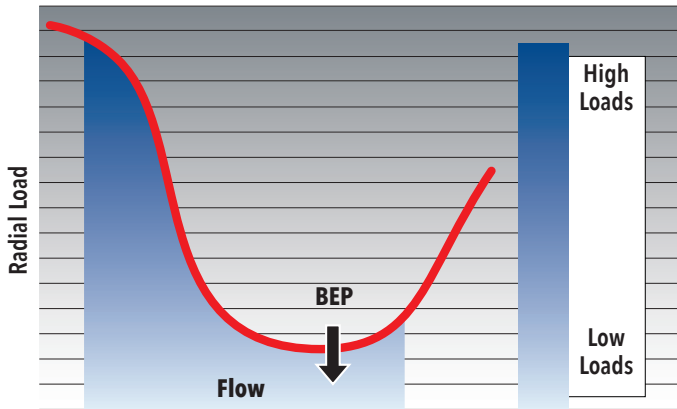

Many processes demand operation off the BEP where higher loads can create damaging vibration.

Process Pump Challenges:

- Due to process changes and variations, the majority of process pumps operate off the BEP where radial loads create high stresses
- Conventional pumps are prone to damaging shaft vibration under off-BEP conditions
- Seal and bearing failures result from vibration damage

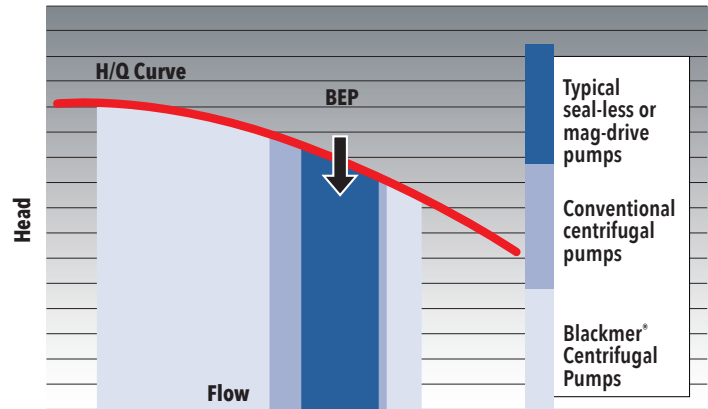

Blackmer® Centrifugal Pumps resist vibration for a larger operational window off the BEP and greater reliability.

Blackmer Centrifugal Pumps are the Solution:

- Heavy-duty design for the toughest applications in the process industry
- Blackmer Centrifugal Pumps are designed to prevent vibration under high radial loads
- Blackmer Centrifugal Pumps offer the widest operational window off the BEP of any standard process pump
- Seals and bearings last longer for greater system reliability
- When your process demands that pumps vary from the BEP, Blackmer will save you money and prevent lost production

Warranty & Performance Assurance

Blackmer offers a five-year power end, and one-year mechanical seal performance assurance guarantee – If any Blackmer Centrifugal power end component fails, a free replacement component will be provided, and if a mechanical seal fails, a spare parts kit will be provided. Blackmer stands behind our Centrifugal Pumps because we know they were built to last and operate in the most severe environments without failing.

Learn more about the Blackmer Centrifugal performance assurances guarantees by visiting: blackmer.com/CentrifugalWarranty

Design Standards

Blackmer Centrifugal Pumps are used by Military and Naval marine vessels around the world, on land and sea – Under the most difficult conditions imaginable. Blackmer Centrifugal and Vane Pumps are approved by the US Military. In fact, these pumps can be found in all US Navy Surface Combatant Vessels providing rock-solid reliability when and where it is needed the most. Our pumps have met numerous military standards for over 50 years.

Meets the following military specifications standards:

- MIL-S-901-D
- MIL-STD-167
- MIL-P-19131
- ASTM DF1510

Blackmer® Centrifugal Pumps

High Temperature Series

Available in the 450°F Line & 650°F Line

Pre-configured to meet your high temperature requirements of 450°F, 650°F and even 750°F, the High Temp Series is available for some Frame A and Frame M Centrifugal Pump models sizes.

Now able to exceed the 400°F (204°C) standard temperature limit of our Centrifugal Pumps, the High Temp Series allows for maximum temperatures of up to 450°F (232°C) with **450°F Line**, 650°F (343°C) with the **650°F Line** or even up to 750°F (398°C) with a special stainless steel frame. Utilizing high temperature flanges and elastomers, along with the unique centerline mount that supports high temperatures, the High Temp Series further entrenches these pumps ability to safely transfer critical and valuable fluids reliability in the harshest of service conditions.

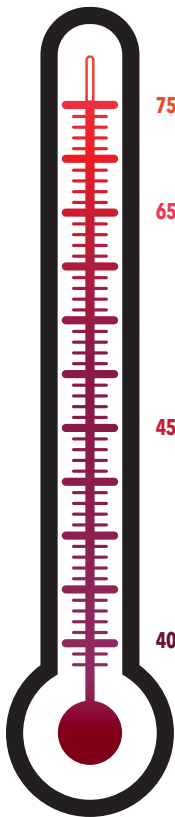

- 750°F (399°C)** Can modify an existing **650°F Line** model with stainless steel frame to meet temperature requirements of up to 750°F (398°C)
- 650°F (343°C) The 650°F Line**
 - Maximum fluid temperatures up to 650°F (343°C)
 - Standard item (8-12 week lead time)
 - High temperature flanges standard
 - Centerline mount standard
 - High temperature elastomers standard
- 450°F (232°C) The 450°F Line**
 - Maximum fluid temperatures up to 450°F (232°C)
 - Standard item (8-12 week lead time)
 - High temperature flanges standard
 - Centerline mount standard
 - High temperature elastomers standard
- 400°F (204°C) Normal Blackmer Centrifugal Pump maximum temperature allowed**

	SIZE	450°F Line	650°F Line
Frame A	2x3-8	✓	✓
	3x4-8	✓	✓
	1x2-10	✓	✓
	1.5x3-10	✓	✓
	2x3-10	✓	✓
	3x4-10	✓	✓
	4x6-10	✓	✓
	1.5x3-13L	✓	✓
	2x3-13L	✓	✓
	3x4-13L	✓	✓
Frame M	4x6-13L	✓	✓
	6x8-13	✓	✓
	8x10-13	✓	✓
	6x8-15	✓	✓
	8x10-15	✓	✓

BLACKMER® CENTRIFUGAL PUMPS

Reliability Features

Blackmer® Centrifugal Pumps are designed specifically to operate in severe applications and resist vibration that would otherwise cause frequent maintenance shutdowns.

- 1 Solid Shaft** (no sleeve) with minimal overhang provides superior resistance to deflection. Lowest L3/D4 ratio in the industry.
- 2 Labyrinth Seals** provide non-wearing lifetime protection for radial and thrust bearings
- 3 Oversized 7310 (pair) Angular Contact Thrust Bearings** are standard for high thrust capability, as required by **API 610** specifications
- 4 Positive Locking Thrust Bearing Retainer Cover** for maximum bearing holding power and minimum axial movement – **API 610**
- 5 Large Bore Seal Chamber** available with optional throat bushing
- 6 Optional Seal Chamber Jacket** for cooling the mechanical seal
- 7 Centerline Casing Support Legs** are adjustable for pipe variations and minimize heat effects, as required by **API 610** specifications
- 8 Rabbet for C-Frame (NEMA) or D-Flange (IEC) Motor Adaptor** provides for automatic mechanical motor alignment without special tools or excessive labor
- 9 Standard Mechanical Seals Can Be Installed On All Centrifugal Pump Frames.** Frame A offers an optional seal chamber jacket for cooling the mechanical seal.
- 10 Impeller** is a single piece casting with solid hub, while also threaded to the shaft. Impeller lock bolts and keyed impellers available as options – **API 610**
- 11 Bushing** options include carbon, polyurethane and SpiralTrac¹

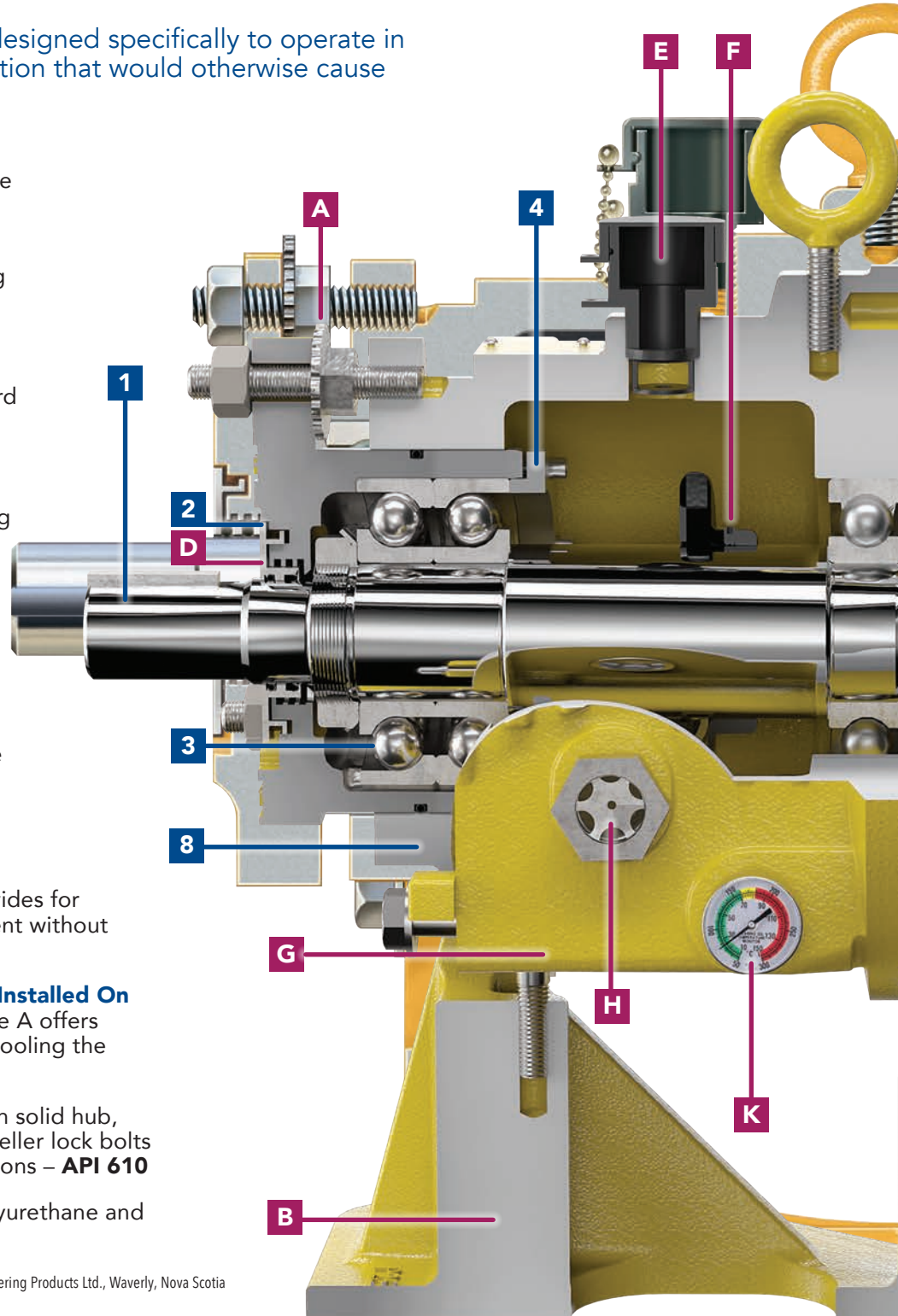

¹SpiralTrac is a registered trademark of the manufacturer, EnviroSeal Engineering Products Ltd., Waverly, Nova Scotia

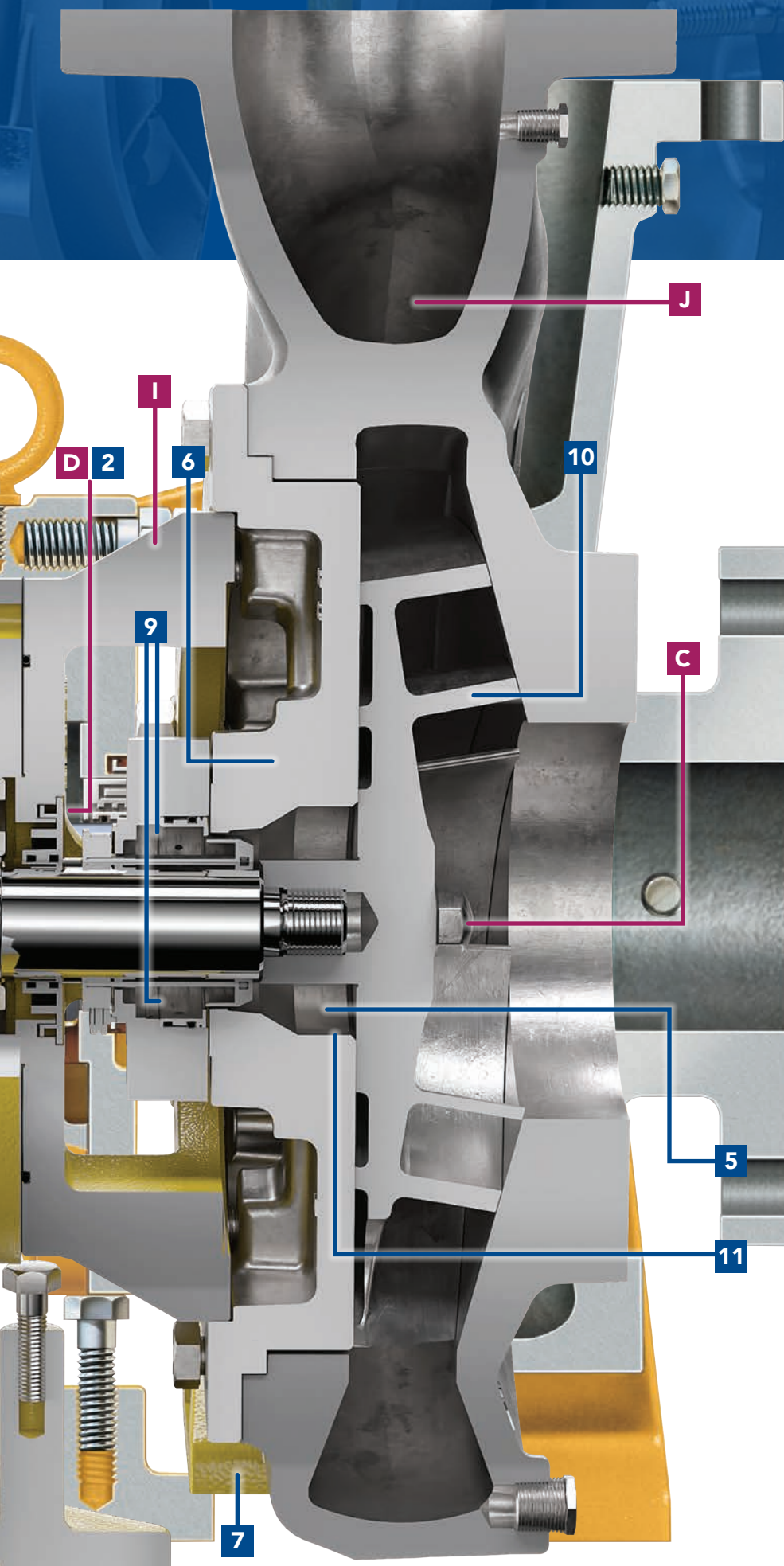

Ease of Use Features

Designed for pump operators, Blackmer® Centrifugal Pumps makes operation, maintenance, and repair simple with these ease of use features.

- A Micrometer Adjustment Nuts** simplify and ensure precise impeller setting for maximum efficiency
- B Full Support Rear Leg** assures bearing frame remains upright during pump disassembly
- C Cast-In Impeller Nut** makes removal easy
- D Labyrinth Seals** provide non-wearing lifetime protection for radial and thrust bearings
- E Large Oil Inlet** for easy filling of oil. Close fitting cover minimizes dirt and moisture entry
- F Flinger Filter** constantly cleans oil during pump operation – **API 610**
- G Two Magnetic Drain Plugs** are provided to maintain clean oil and are removable for insertion of cooling coil – **API 610**
- H Oil Sight Glass** for constant monitoring of oil level and condition
- I Frame A Adapter** has a 180° unobstructed opening for ease of maintenance
- J Casting Methods** State-of-the-art casting methods provide smoothest possible surfaces for highest efficiency
- K Optional Bearing Oil Temperature Monitor** indicates potential failure of bearings and/or lubrication by an increase in oil temperature

CENTRIFUGAL FOCUS AREAS

Blackmer® Centrifugal Pumps are designed around the seal, bearing and shaft, which account for 90% of failures for generic pumps.

Addresses, Solves, Fixes Common Centrifugal Pain Areas

About 90% of centrifugal pump failures are with the seal, bearing and shaft

Packing & Seal

We offer a 1-year mechanical seal guarantee. We are confident in our mechanical seals not failing because Blackmer® Centrifugal Pumps are designed and built to prevent this from happening:

- Our low to no deflection shafts are shorter and thicker than competing shafts, saving the mechanical seals from violent wear due to shaft deflection
- Large bore seal chamber lubricates, cleans and cools the seal to prevent premature seal failures. Our seal chambers are designed without a backstop, which eliminates dead space and allows the fluid to move in and move out keeping the mechanical seal face in a cleaner and cooler environment. Unlike traditional ANSI pumps where fluid and debris get trapped right in front of the mechanical seal face, building up with debris and heat which negatively impact the mechanical seal

Seal Chamber Jacket

This optional feature provides an API Plan 2 external cooling to the pump. This will prevent seal failure due to thermal shock, with sudden and drastic temperature changes which can crack the brittle mechanical seal faces.

Centerline Casing Support Legs

The centerline casing support legs allow our Centrifugal Pumps to operate in high temperatures of up to 400°F. The centerline casing support legs allow the pump to “float,” this design feature gives the pump room to expand both vertically and horizontally due to thermal expansion. This prevents the questionable thermal growth on the casing that happens with many other ANSI pumps which reduces the life and reliability of the mechanical seal.

C-Frame (NEMA) or D-Flange (IEC) Motor Adapter

The design of the C-Frame adapter eliminates any misalignment concerns, removing any unnecessary strain on the pumping elements – especially the mechanical seal. It increases pump reliability by reducing vibration and prolonging mechanical seal life.

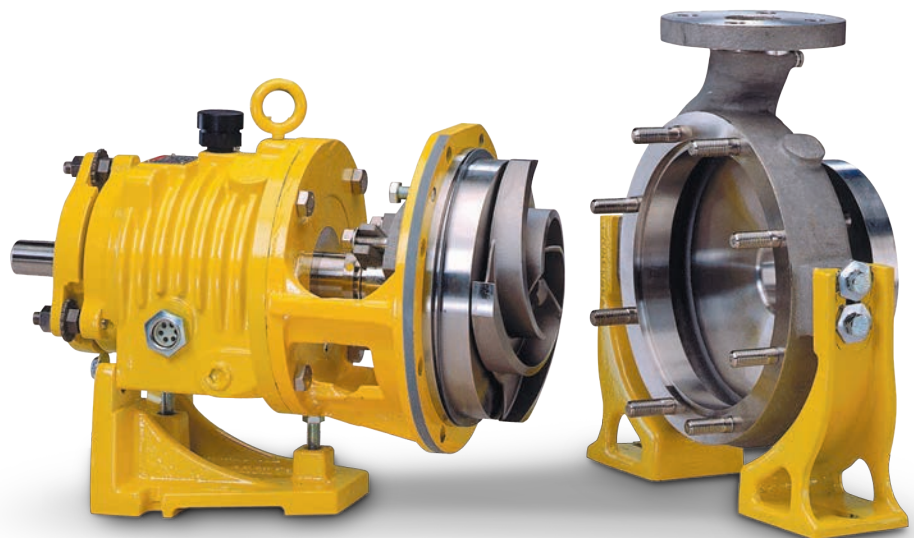



Bearings

Heavy-duty bearings with longer bearing life

- Blackmer® Centrifugal Pump bearings are one to two times size larger than generic bearings in ANSI centrifugal pumps
- Larger bearings, allow for greater load capacity and longer bearing life
- Bearings are retained, meaning the lock collar bolted retainer features eight bolts securing it to the thrust cartridge. This positively engages the thrust bearing and eliminates all the dynamic loads on the bearing.
- Bolt retainer cover locks thrust bearing into a cartridge for enhanced reliability
- Blackmer Centrifugal Pump angular collar thrust bearings are the same ones specified by API 610
- We are so confident our bearings will last, we offer a five year bearing guarantee

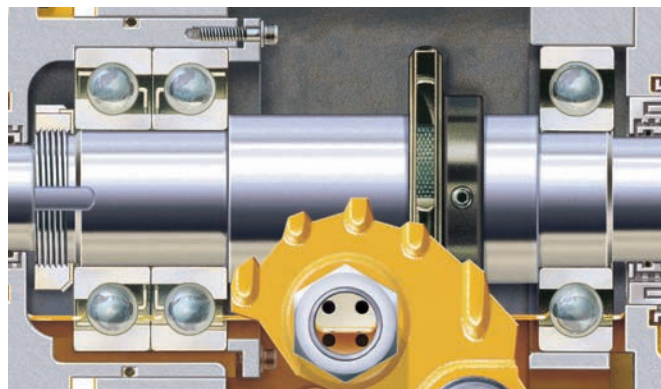

Shafts & Shaft Sleeve

- Blackmer Centrifugal Pump shafts are of one-piece solid design, which means no sleeves are used
- Shafts of our Centrifugal Pumps are much shorter and much thicker than competing ANSI pump shafts
- A shorter and thicker shaft, means low deflection (the degree to which a shaft is displaced under a load):
 - This prevents very common damage due to vibration
 - Increases stability at the seal area, improving operating life of the seal by reducing wear and pressure on the mechanical seal
 - Extends bearing life, because a short shaft overhang reduces bearing load

Blackmer® Centrifugal Pumps feature the lowest shaft deflection ratios of all ANSI centrifugal pumps.

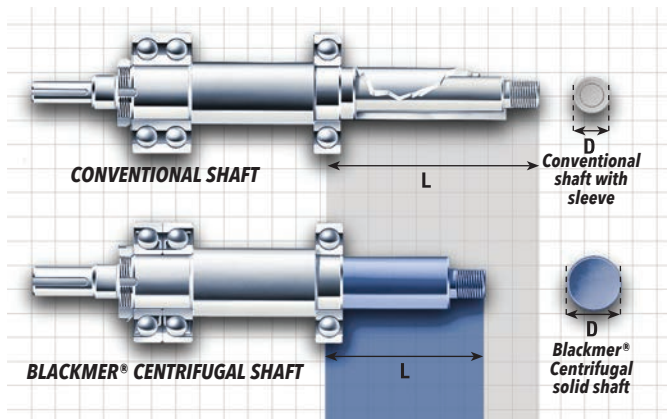

API 610 Features

Blackmer Centrifugal Pumps are designed and constructed to provide maximum service life, comply with key parts of the API 610 standard for centrifugal pumps, and can be a cost-effective alternative to pumps that are in full compliance with the standard.

- Designed and constructed to meet the minimum standard of a 20-year service life and three years uninterrupted operation
- ANSI/ASME class 300 flanges option
- Self-venting top discharge with threaded casing drains are available as an option. Additional available options include flanged drains and side discharge. Flanged drains also an option. Optional side discharge is also available.
- Bearing housings can be removed from service without disturbing the driver. Sufficient cooling is achieved with a large oil sump and deep cooling fins. For extreme temperature operations, a copper coiling coil is an available option, and labyrinth seals are standard equipment.
- Offered with standard and optional materials that comply with the material classes

Frame S Pump

- Mid size frame strength and reliability in small frame space
- Heavy duty alternative to standard small frame pumps
- Lowest L3/D4 stiffness ratio of any competitive size pump 26 (1.9) Frame S
- Meets ASME/ANSI dimensional specifications
- Capacities up to 450 gpm (102 m³/hr)
- Operating temperature range from -40° to 400°F (-40° to 204°C)
- Military shock standard S901 Grade A

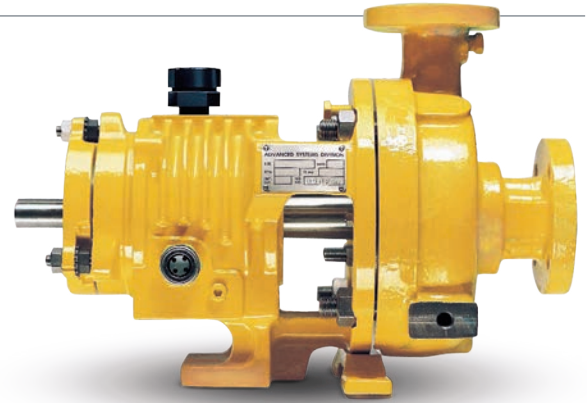

Frame S (ASME/ANSI)

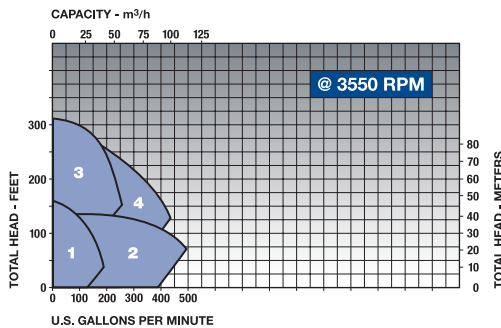
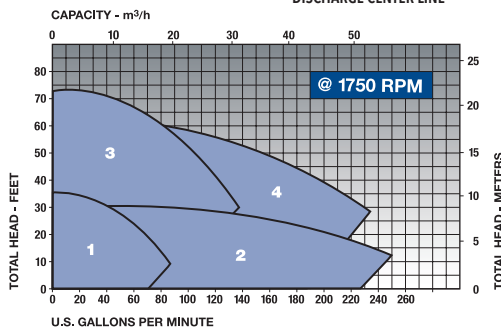
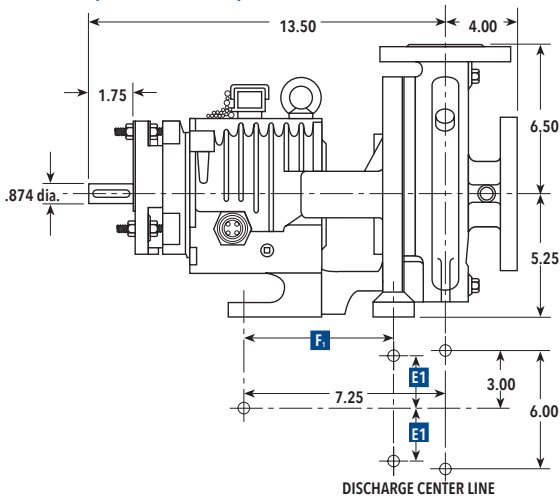

Frame S (Metric)

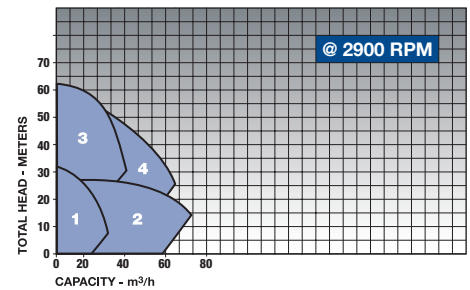
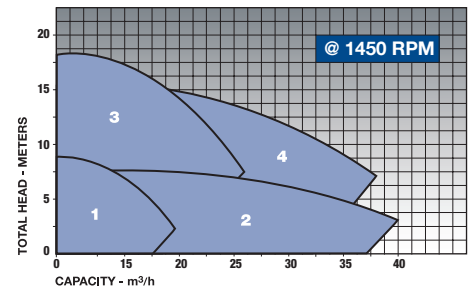
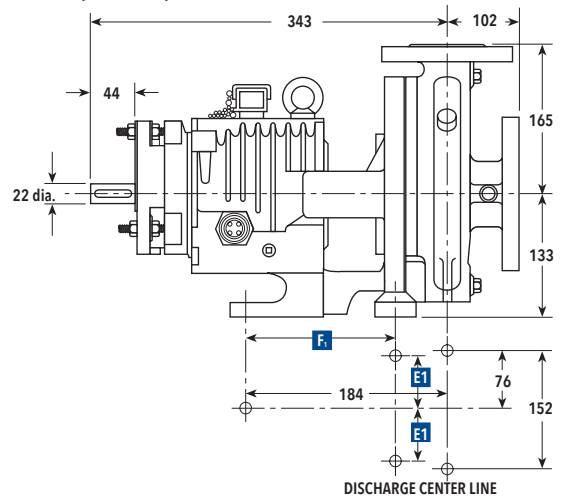

Frame S Pump – ASME/ANSI

	Pump Size	F ₁	2E ₁
1	1 x 1.5-6	4.88	5.50
2	2 x 3-6	4.88	5.50
3	1 x 1.5-8	4.25	7.50
4	1.5 x 3-8	4.25	7.50

All dimensions are in inches.

Frame S Pump – Metric

	Pump Size	F ₁	2E ₁
1	1 x 1.5-6	124	140
2	2 x 3-6	124	140
3	1 x 1.5-8	101	191
4	1.5 x 3-8	108	191

All dimensions are in millimeters.

Blackmer® Centrifugal Pumps Design Data | Frame S (ANSI)

	1x1.56	2x3-6	1x1.5-8	1.5x3-8
Shaft				
L ³ /D ⁴ Ratio	46 (1.9)			
Diameter at Impeller	.75-10UNC Thread (19)			
Diameter at Seal	1.500 (38)			
Diameter Between Bearings	1.98 (50)			
Diameter at Coupling	0.874 (22)			
Bearings				
Thrust	5308 AHC3			
Thrust Option	7308 BEGBY (pair)			
Radial	6308 C3			
Bearing Span	3.86 (98)			
Shaft Overhang	6.15 (156)			
Seal Chamber				
Seal Bore Diameter (nose)	2.38 (60)			
Inside Bore	3.44 (87)			
Depth	2.21 (56)			
Back Cover/Shaft Clearance	.02 Diametral (.5)			
Gland Bolting	4X .375-16UNC on 3.50 Bolt Circle Diameter (10 on 89 B.C.)			
Distance to Nearest Obstruction	2.38 (60)			
Open Impeller				
Clearance	.06 (1.5) Total .015 (0.4) Suction Side			
Eye Area sq. in. (cm ²)	3.30 (21)	8.10 (52)	4.13 (27)	5.71 (37)
Maximum Diameter Solids	0.3 (8)	0.6 (15)	0.4 (10)	0.5 (13)
Number of Vanes	4	5	5	5
Pumps Weights lbs/kg				
Pump Only	110 (50)	130 (59)	112 (50)	126 (57)
Casing				
Type	Single Volute			
Wall Thickness	0.44 (11) Minimum			
Maximum Working Pressure	See Pressure vs. Temperature Limit Chart			
Test Pressure	Class 150 Flanges-250PSIG, Class 300 Flanges-450PSIG			
Rotating Element				
Wk ² Dry lbs-ft ² (kg-m ²)	0.18 (.007)	0.24 (.010)	0.38 (.015)	0.43 (.018)
Wk ² Wet lbs-ft ² (kg-m ²)	0.27 (.011)	0.36 (.015)	0.57 (.024)	0.66 (.028)
Maximum Speed (oil lube)	3500	3500	3500	3500
Power Limits				
HP (KW)/100 RPM 316SS	1.1 (0.9)			

Lowest L³/D⁴ stiffness ratio for any competitive size pump in the industry.

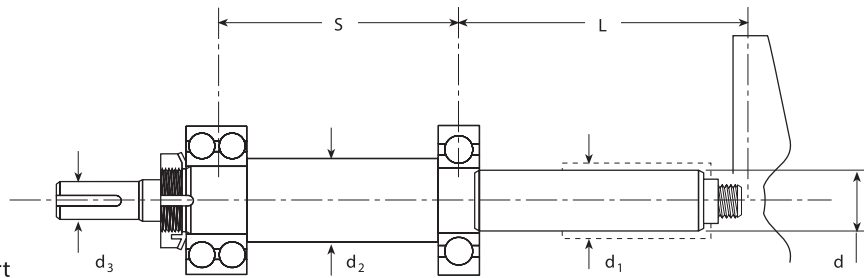

Shaft Stiffness Ratio Comparison Chart

		Blackmer Centrifugal Frame S	Competitor A with Sleeve	Competitor A Solid Shaft	Competitor B with Sleeve	Competitor B Solid Shaft
SHAFT DIAMETERS	In Stuffing Box (Less Sleeve)(d)	1 1/2 (38)	1 1/8 (28)	1 3/8 (35)	7/8 (22)	1 1/8 (28)
	In Stuffing Box (With Sleeve)(d ₁)	N/A	1 3/8 (35)	N/A	1 1/8 (28)	N/A
	Between Bearings (d ₂)	2 (51)	1 1/2 (38)	1 1/2 (38)	1 1/4 (32)	1 1/4 (32)
	At Coupling (d ₃)	7/8 (22)	7/8 (22)	7/8 (22)	7/8 (22)	7/8 (22)
BEARINGS	Radial	6308	6207	6207	6206	6206
	Thrust	5308	5306	5306	5305	5305
	Bearing Span (S)	3.86 (98)	4.12 (105)	4.12 (105)	4.06 (103)	4.06 (103)
	Shaft Overhang (L)	6.15 (156)	6.12 (155)	6.12 (155)	5.87 (149)	5.87 (149)
STIFFNESS RATIO¹	L ³ /D ⁴	46 (1.9)	143 (4.5)	64 (2.5)	346 (14.3)	127 (4.4)

¹For good vibration resistance, especially at speeds above 1750 RPM, the stiffness ratio should not exceed 60 in the seal area. The higher the ratio, the higher the frequency of downtimes, especially as related to bearing and seal failures. The pump has less resistance to the common running conditions which cause vibration – running off Best Efficiency Point (BEP), cavitation, motor misalignment, water hammer, worn parts, plugged or unbalanced impellers, poor piping.

Blackmer® Centrifugal Assembly & Parts List | Frame S Horizontal 6"

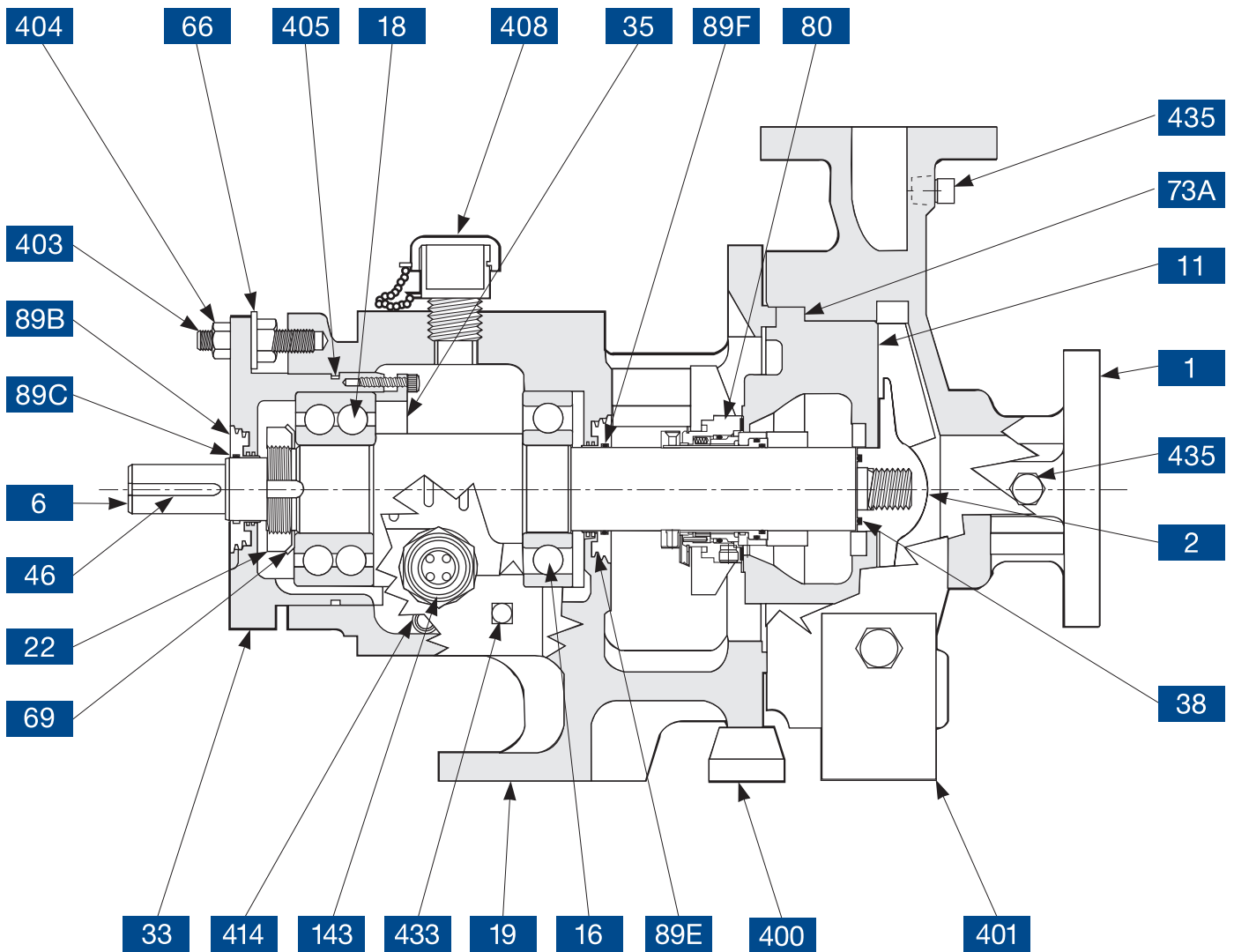

NO.	ITEM	NO.	ITEM	NO.	ITEM
1	Casing	38	O-ring, Impeller Hub	143	Oil Sight Glass
2	Impeller	46	Key, Coupling	400	Foot, Bearing Frame
6	Shaft	66	Micrometer Nut	401	Foot, casing (optional)
11	Back Cover	69	Lockwasher, Thrust Bearing	403	Stud, Cartridge
16	Bearing, Radial	73A	Gasket, Casing	404	Locknut, Cartridge
18	Bearing, Thrust	80	Mechanical Seal	405	O-Ring, Cartridge
19	Bearing, Frame	89E	Seal, Labyrinth Rotor, Radial	408	Oil Filler Assembly
22	Locknut, Thrust Bearing	89F	Seal, Labyrinth O-Ring, Radial	414	Plug, Magnetic
33	Bearing Cartridge	89B	Seal, Labyrinth Rotor, Thrust	433	Plug, Bearing Frame
35	Retainer Cover	89C	Seal, Labyrinth O-Ring, Thrust	435	Plug, Casing

Blackmer® Centrifugal Assembly & Parts List | Frame S Horizontal 8"

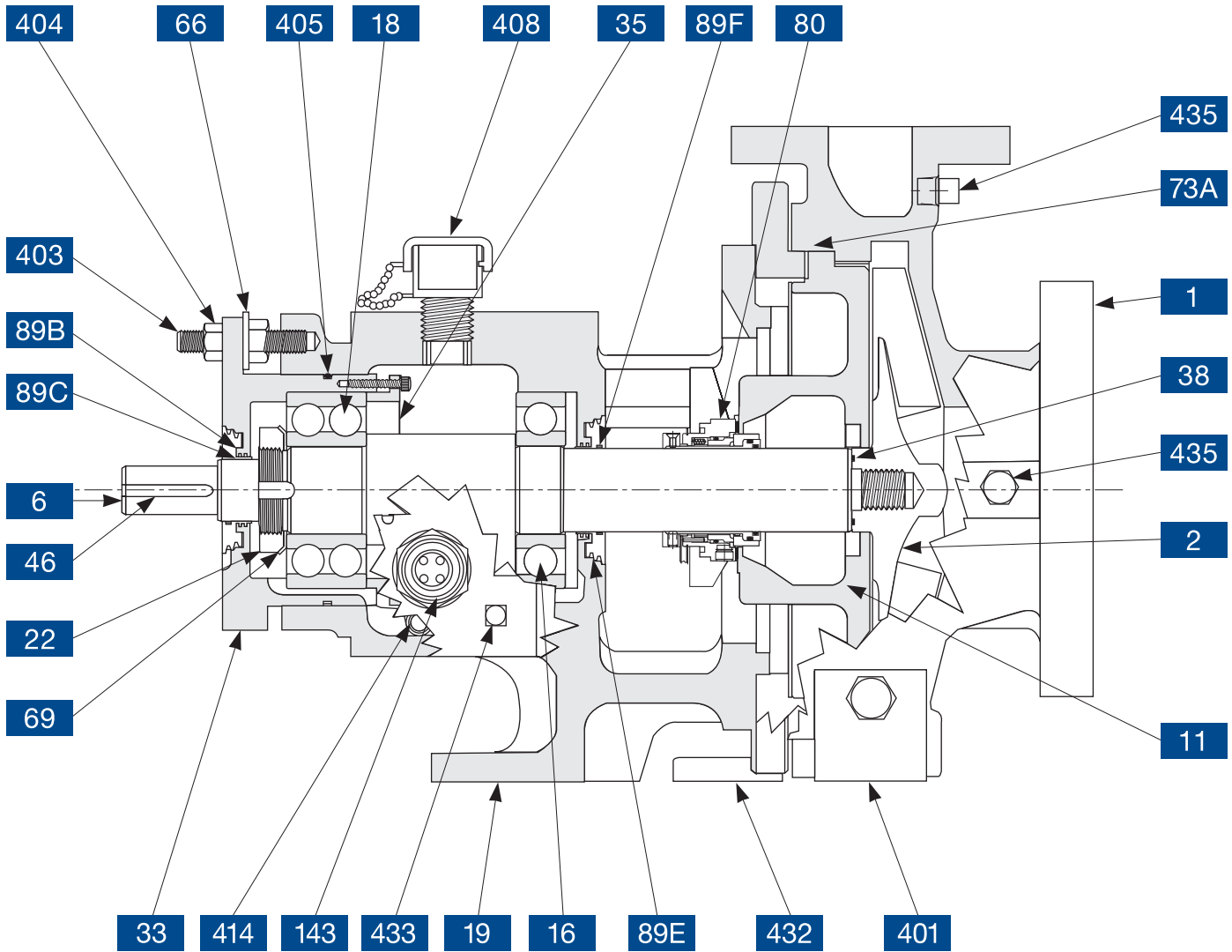

NO.	ITEM	NO.	ITEM	NO.	ITEM
1	Casing	46	Key, Coupling	401	Foot, casing (optional)
2	Impeller	66	Micrometer Nut	403	Stud, Cartridge
6	Shaft	69	Lockwasher, Thrust Bearing	404	Locknut, Cartridge
11	Back Cover	73A	Gasket, Casing	405	O-Ring, Cartridge
16	Bearing, Radial	80	Mechanical Seal	408	Oil Filler Assembly
18	Bearing, Thrust	89E	Seal, Labyrinth Rotor, Radial	414	Plug, Magnetic
19	Bearing, Frame	89F	Seal, Labyrinth O-Ring, Radial	432	Adapter Plate
22	Locknut, Thrust Bearing	89B	Seal, Labyrinth Rotor, Thrust	433	Plug, Bearing Frame
33	Bearing Cartridge	89C	Seal, Labyrinth O-Ring, Thrust	435	Plug, Casing
35	Retainer Cover	143	Oil Sight Glass		
38	O-ring, Impeller Hub	400	Foot, Bearing Frame		

Blackmer® Centrifugal Auxiliary Pipe Connections List | Frame S

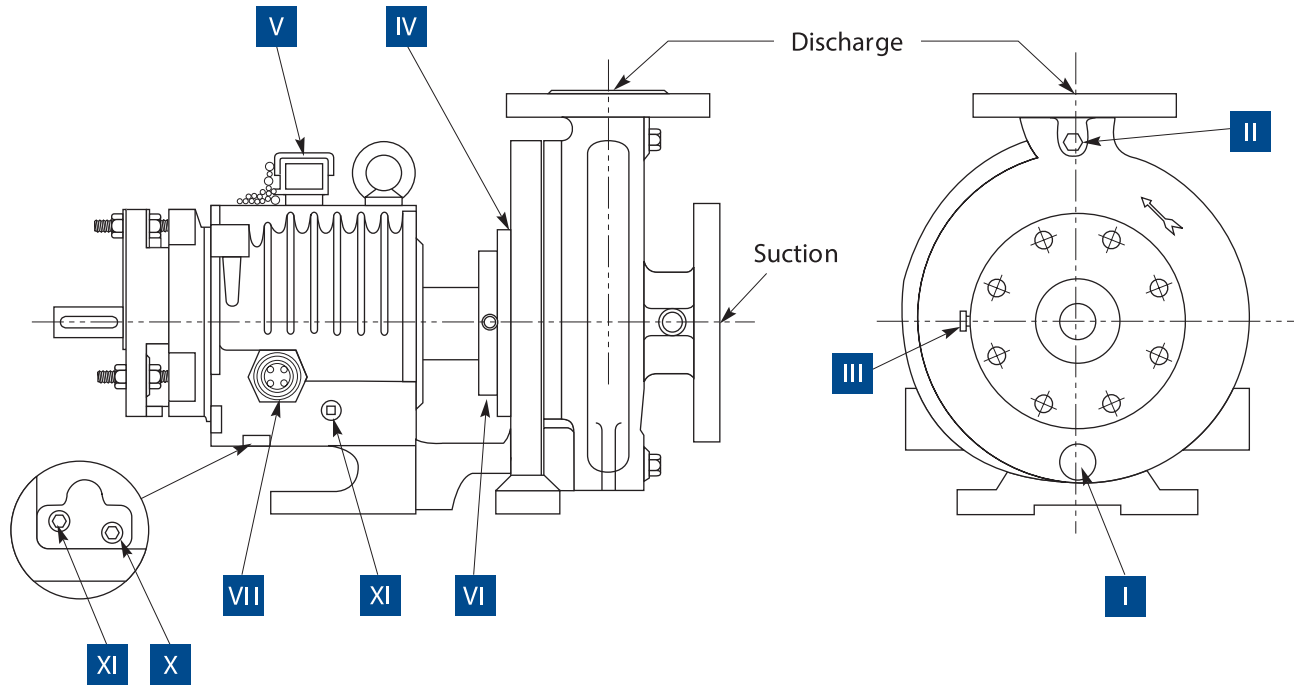

ITEM NUMBER	NPT SIZE	NUMBER OF TAPS	CONNECTION
* I	0.38-18	1	Casing Drain
II	0.25-18	1	Discharge Gage
III	0.25-18	1	Suction Gage
IV	0.12-27	1	Seal Chamber Flush
V	0.75-14	1	Oil Fill
* VI	0.25-18 & 0.12-27	2	Seal Chamber Jacket-Inlet & Outlet
# VII	0.75-14	1	Oil Sight Glass
## X	0.25-18	1	Oil Drain
XI	0.25-18	2	Magnetic Plug or Cooling Coil*

* Optional

Left side of pump facing suction end

Right side of pump facing suction end

Blackmer® Centrifugal Composite Pump Curves | Frame S

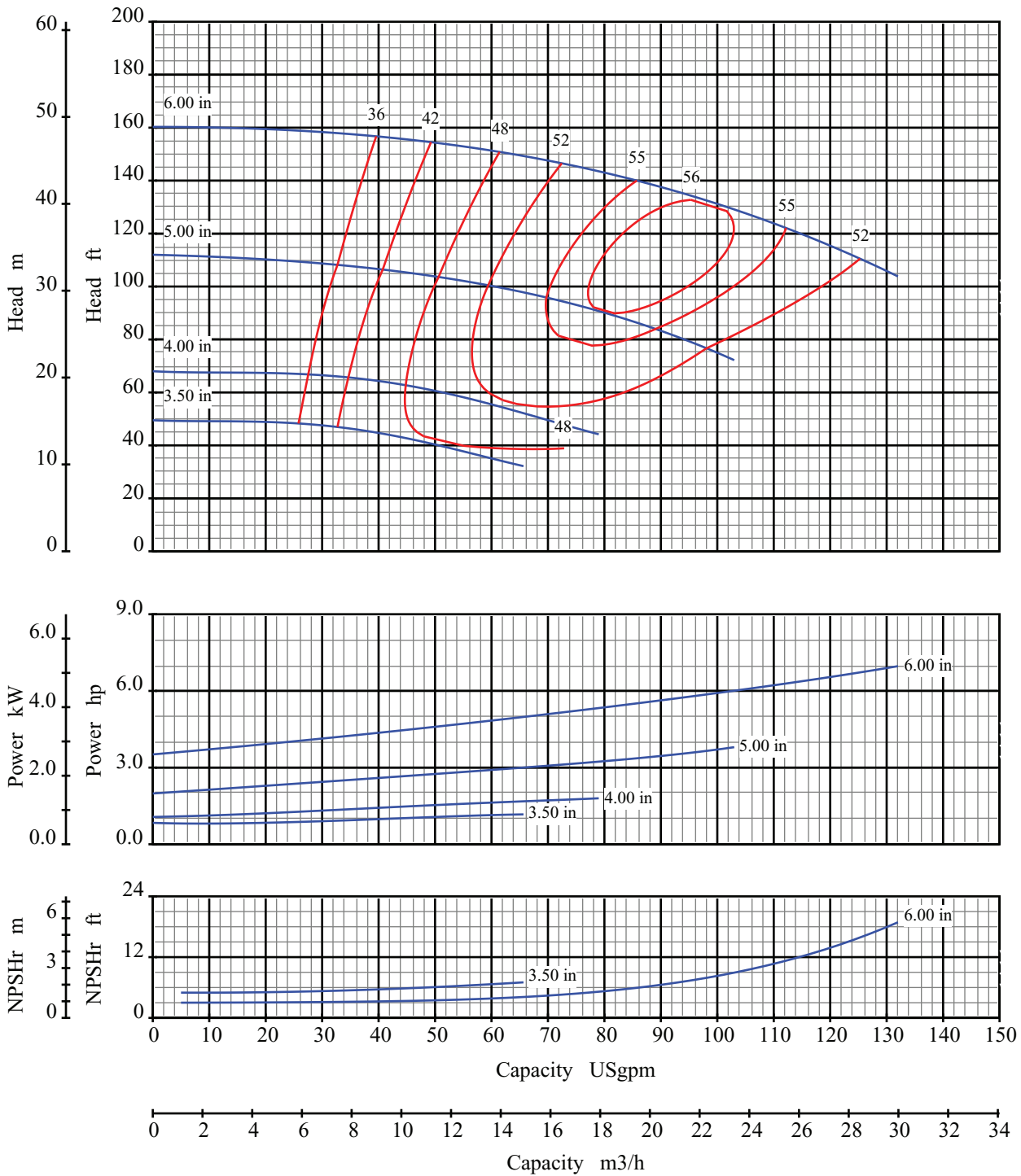

Curve No: S18100V1

Blackmer Centrifugal

Pump Size: 1x1.5 6

Pump Performance Characteristics

Effective Date: Jan/2005

Catalog: 1301

Speed: 3550 rpm

Open Impeller

Blackmer® Centrifugal Composite Pump Curves | Frame S

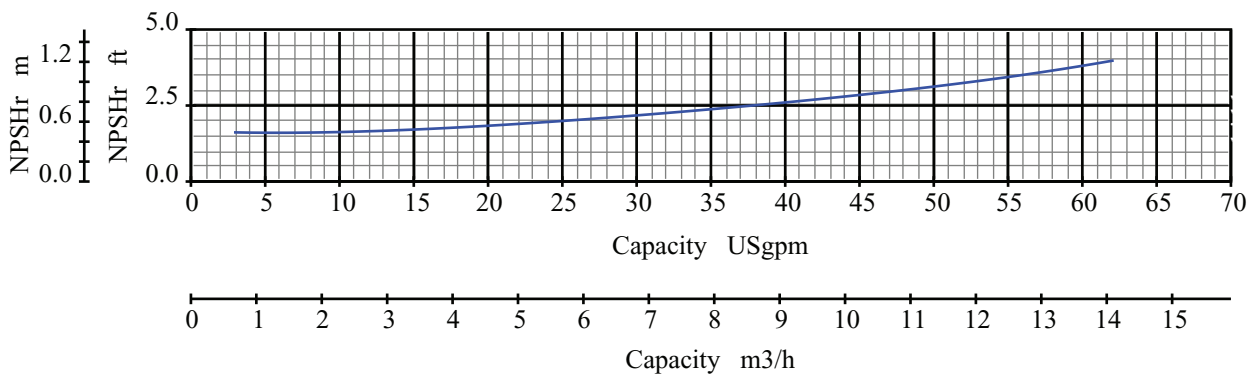
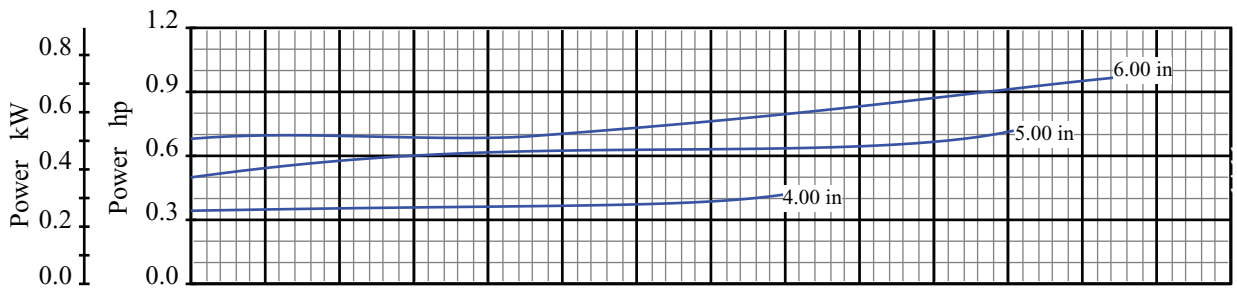
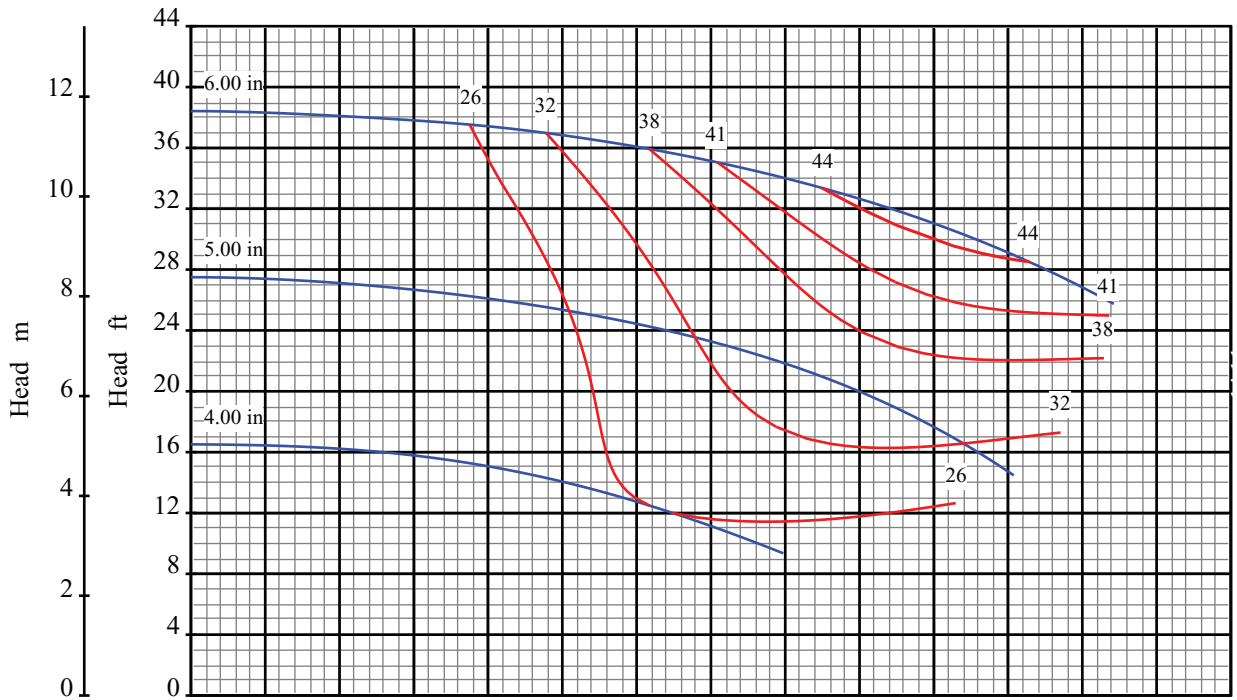

Curve No: S18102V1

Blackmer Centrifugal

Pump Size: 1x1.5 6

Pump Performance Characteristics

Effective Date: Jan/2005

Catalog: 1301

Speed: 1750 rpm

Open Impeller

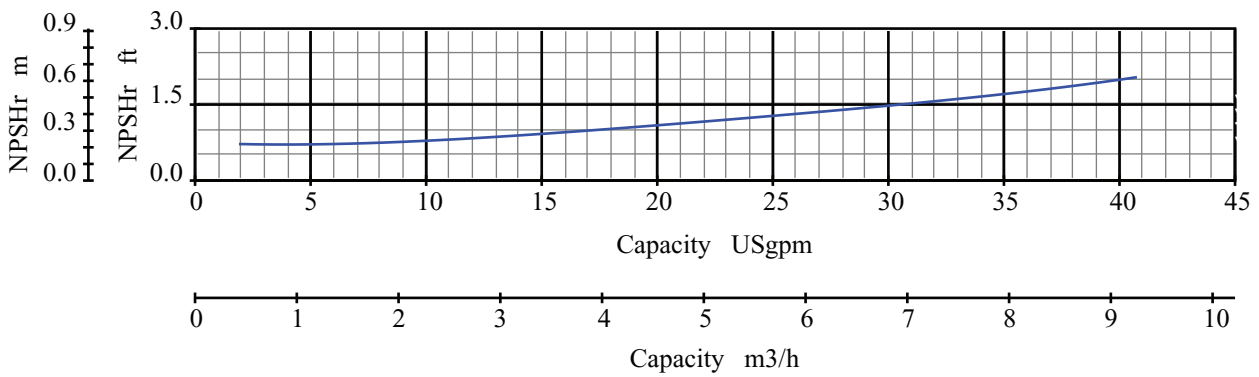
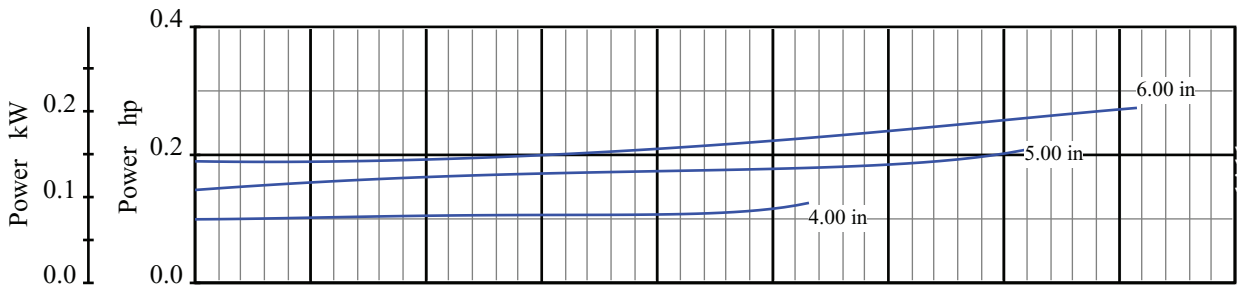
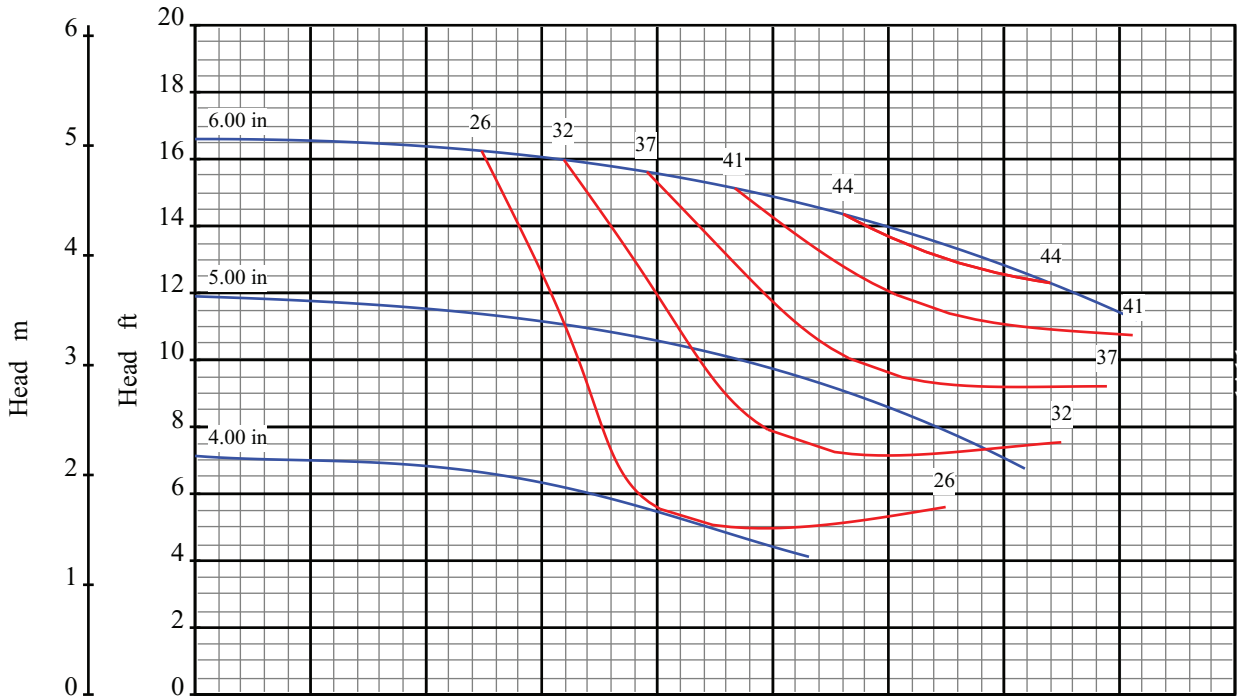

Curve No: S18104V1

Blackmer Centrifugal

Pump Size: 1x1.5 6

Pump Performance Characteristics

Effective Date: Jan/2005

Catalog: 1301

Speed: 1150 rpm

Open Impeller

Blackmer® Centrifugal Composite Pump Curves | Frame S

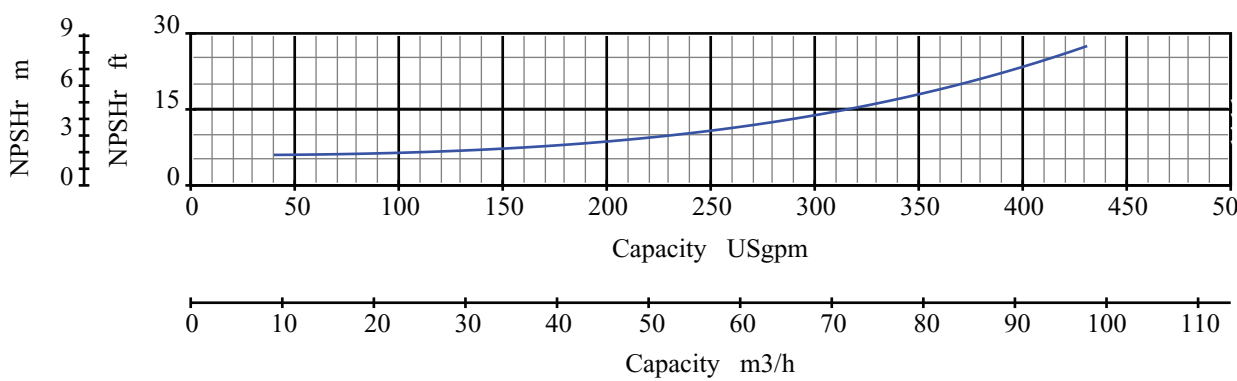
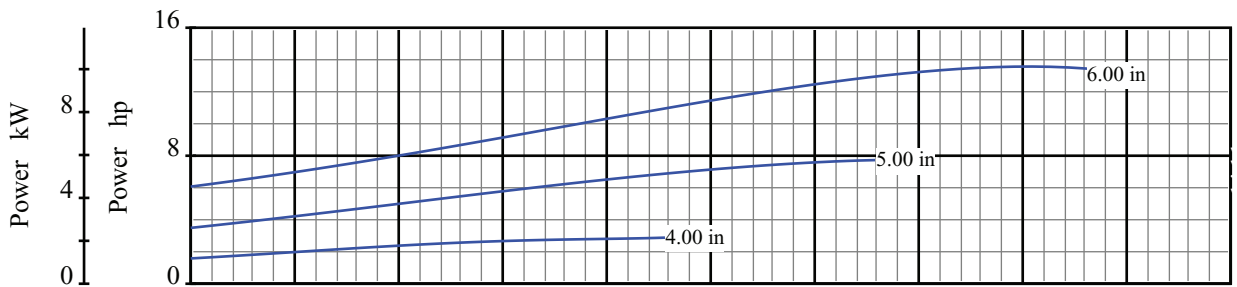
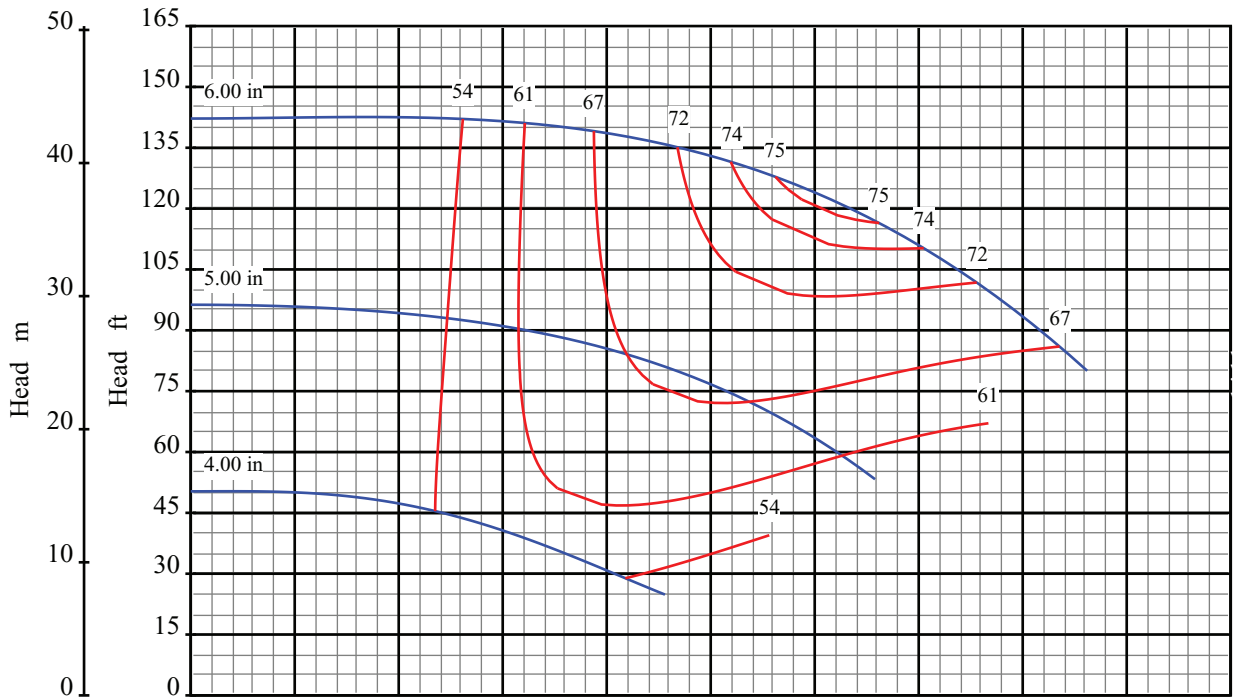

Curve No: S18106V1

Blackmer Centrifugal

Pump Size: 2x3 6

Pump Performance Characteristics

Effective Date: Jan/2005

Catalog: 1301

Speed: 3550 rpm

Open Impeller

Blackmer® Centrifugal Composite Pump Curves | Frame S

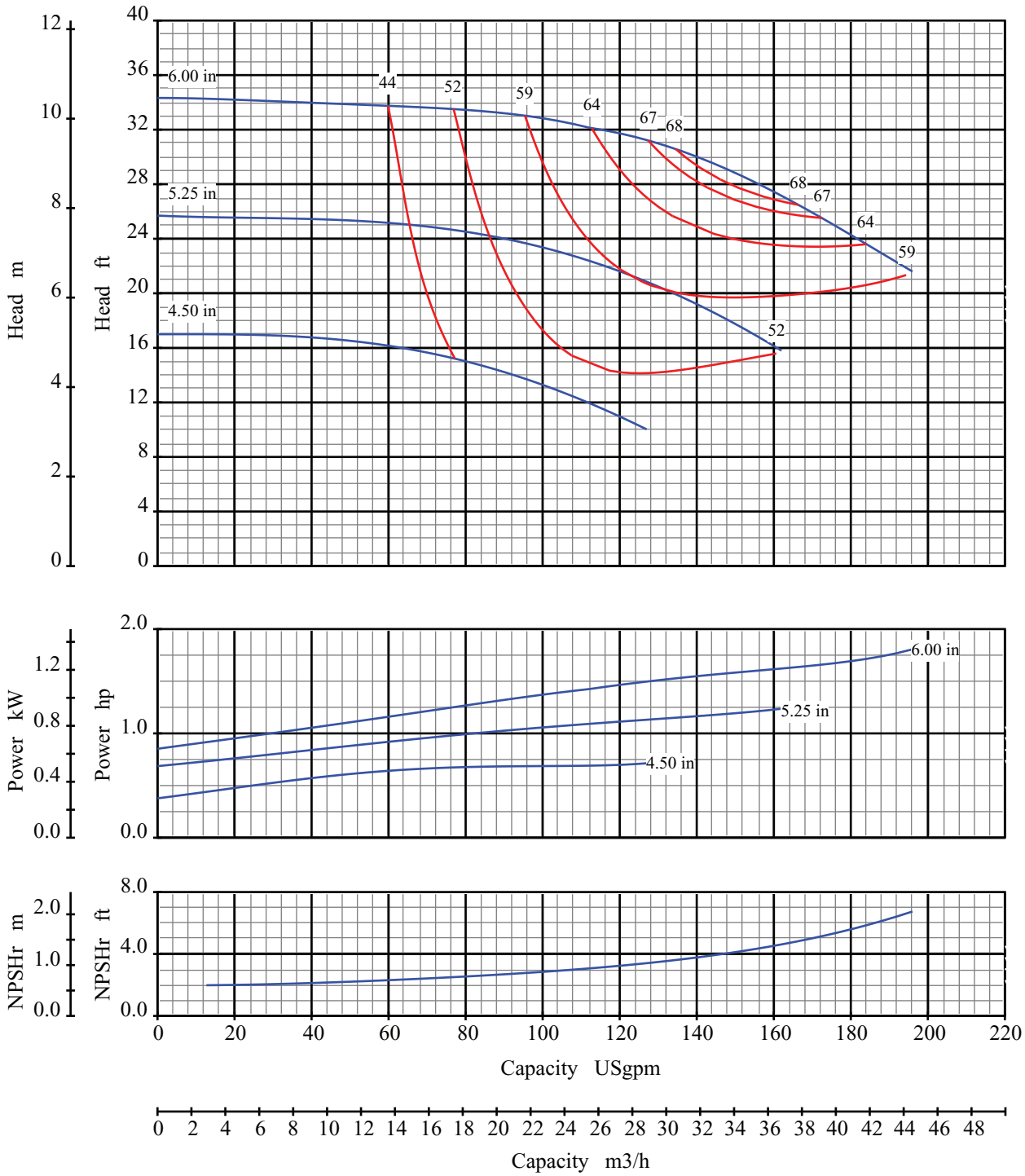

Curve No: S18108V1

Blackmer Centrifugal

Pump Size: 2x3 6

Pump Performance Characteristics

Effective Date: Jan/2005

Catalog: 1301

Speed: 1750 rpm

Open Impeller

Blackmer® Centrifugal Composite Pump Curves | Frame S

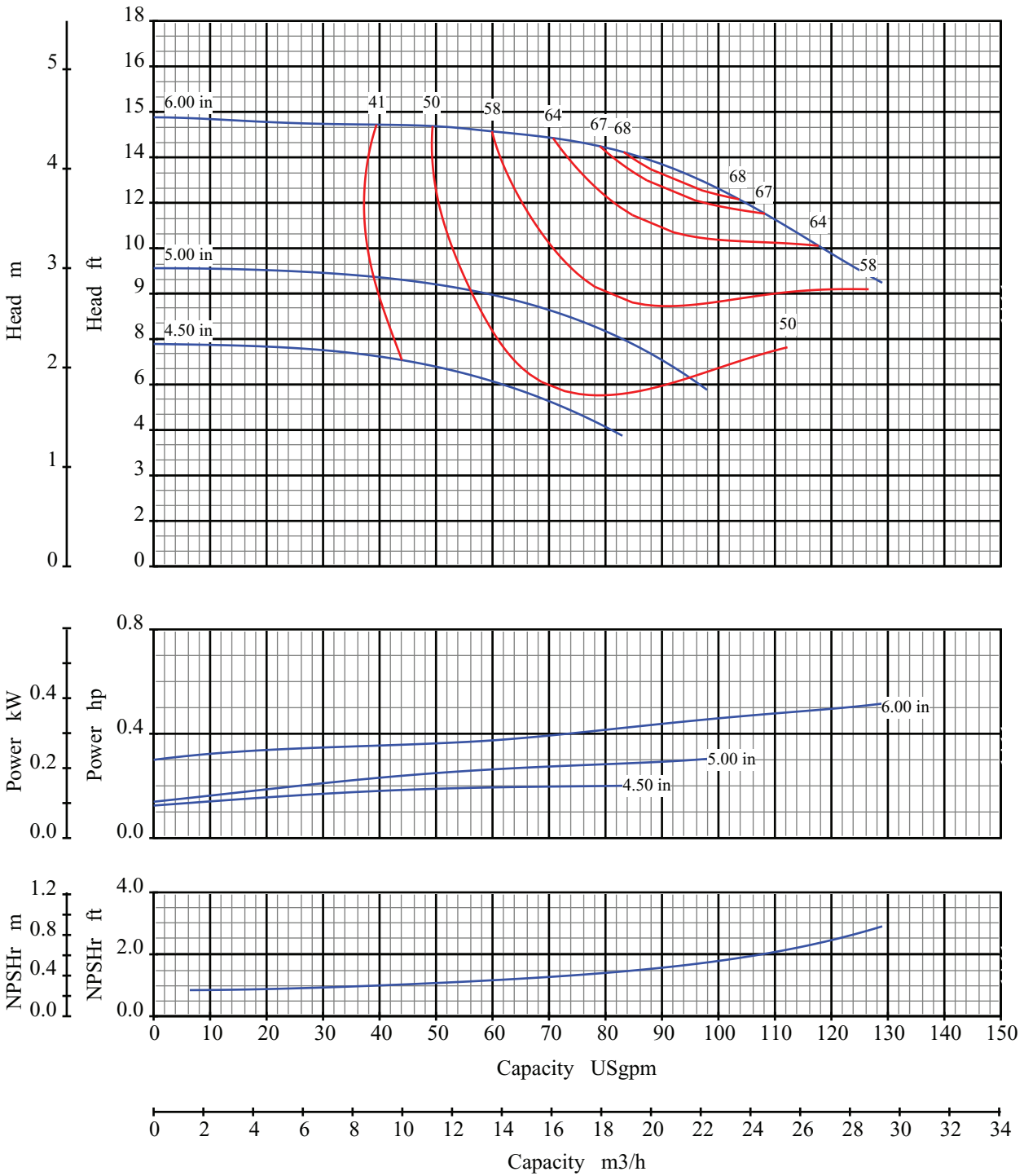

Curve No: S18110V1

Blackmer Centrifugal

Pump Size: 2x3 6

Pump Performance Characteristics

Effective Date: Jan/2005

Catalog: 1301

Speed: 1150 rpm

Open Impeller

Blackmer® Centrifugal Composite Pump Curves | Frame S

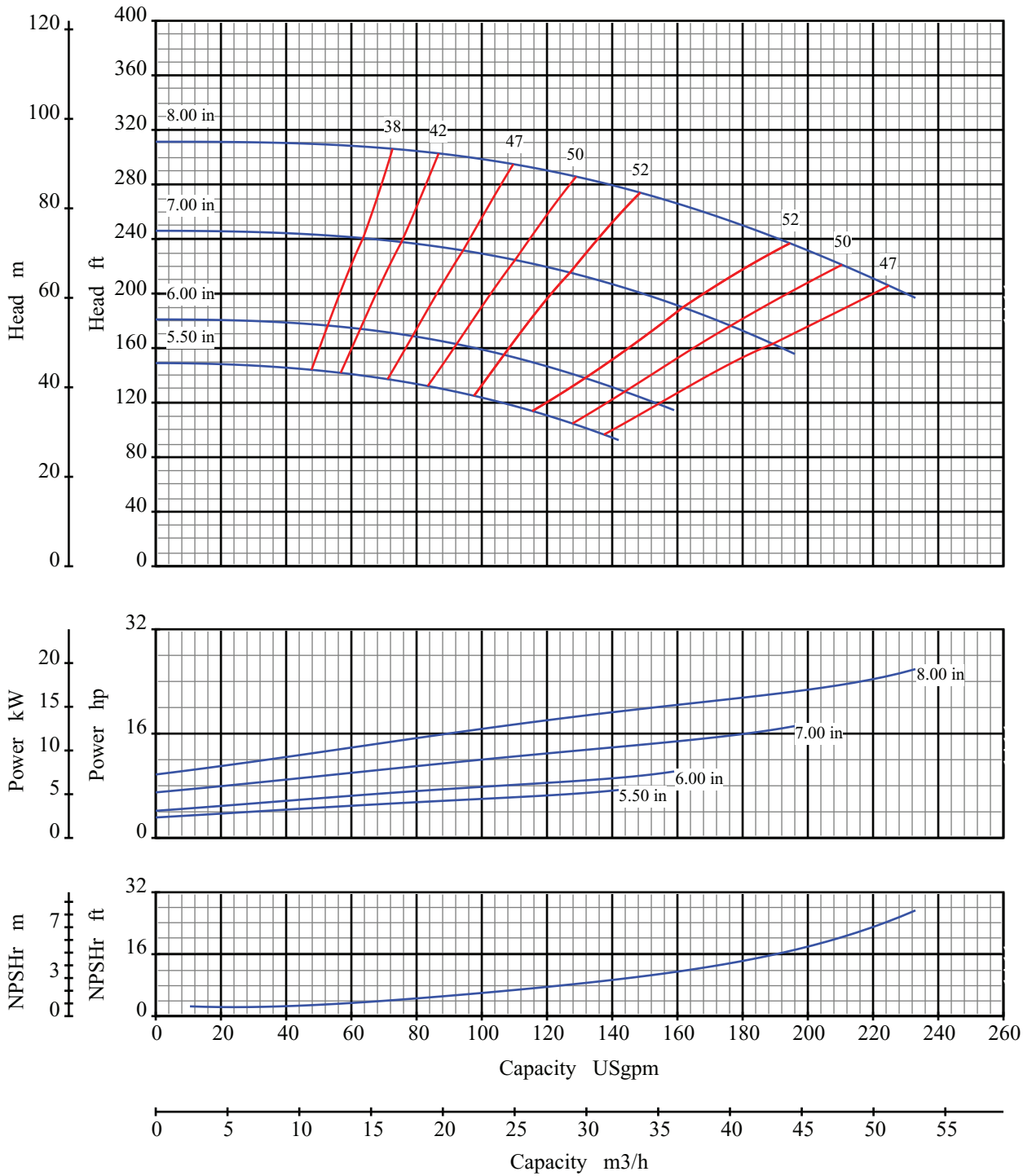

Curve No: S18112V1

Blackmer Centrifugal

Pump Size: 1x1.5 8

Pump Performance Characteristics

Effective Date: Jan/2005

Catalog: 1301

Speed: 3550 rpm

Open Impeller

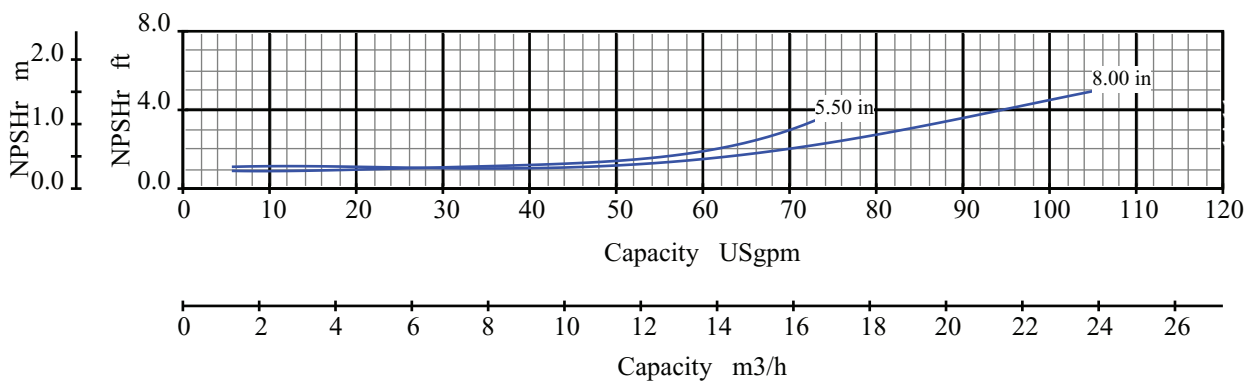
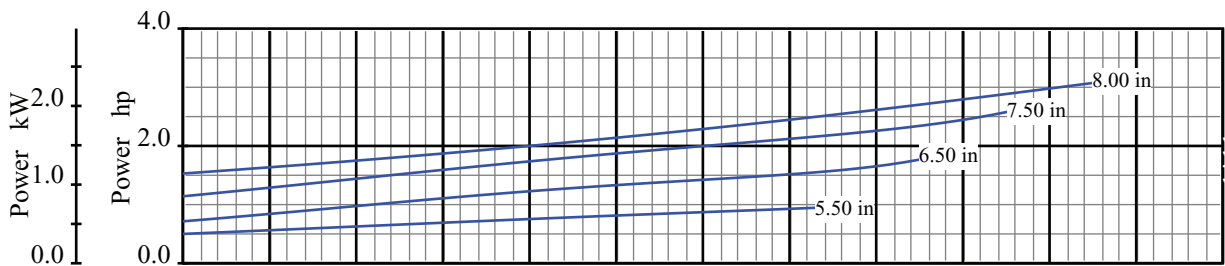
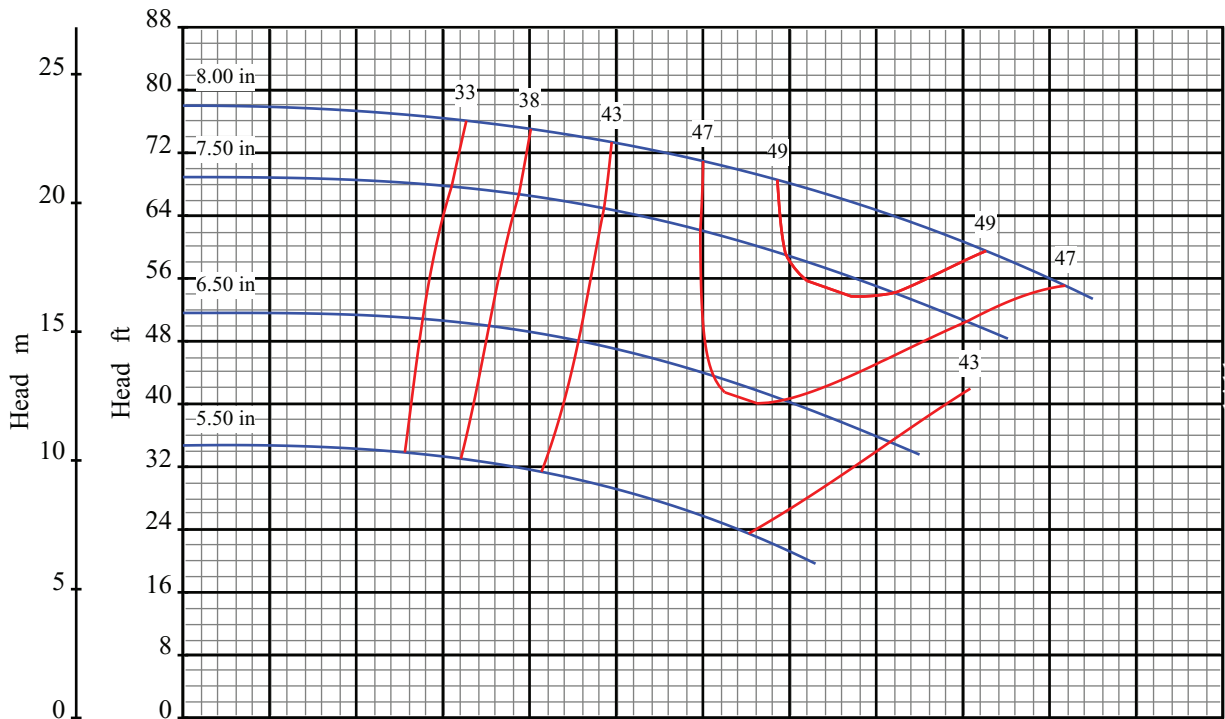

Curve No: S18114V1

Blackmer Centrifugal

Pump Size: 1x1.5 8

Pump Performance Characteristics

Effective Date: Jan/2005

Catalog: 1301

Speed: 1750 rpm

Open Impeller

Blackmer® Centrifugal Composite Pump Curves | Frame S

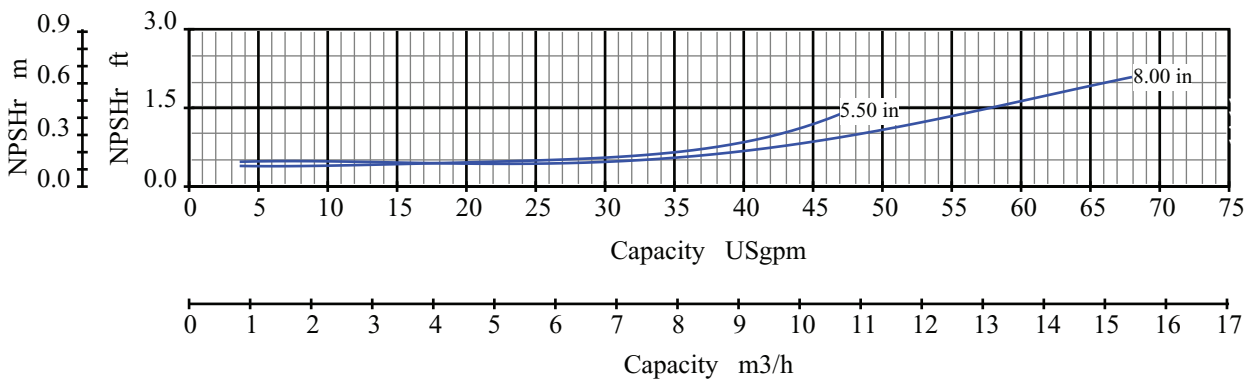
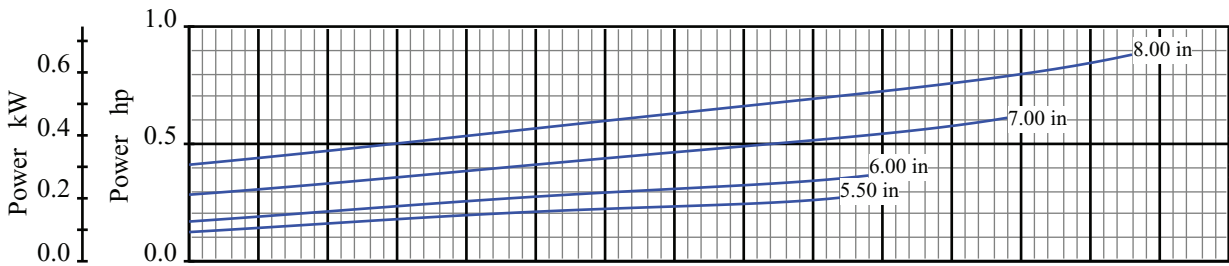
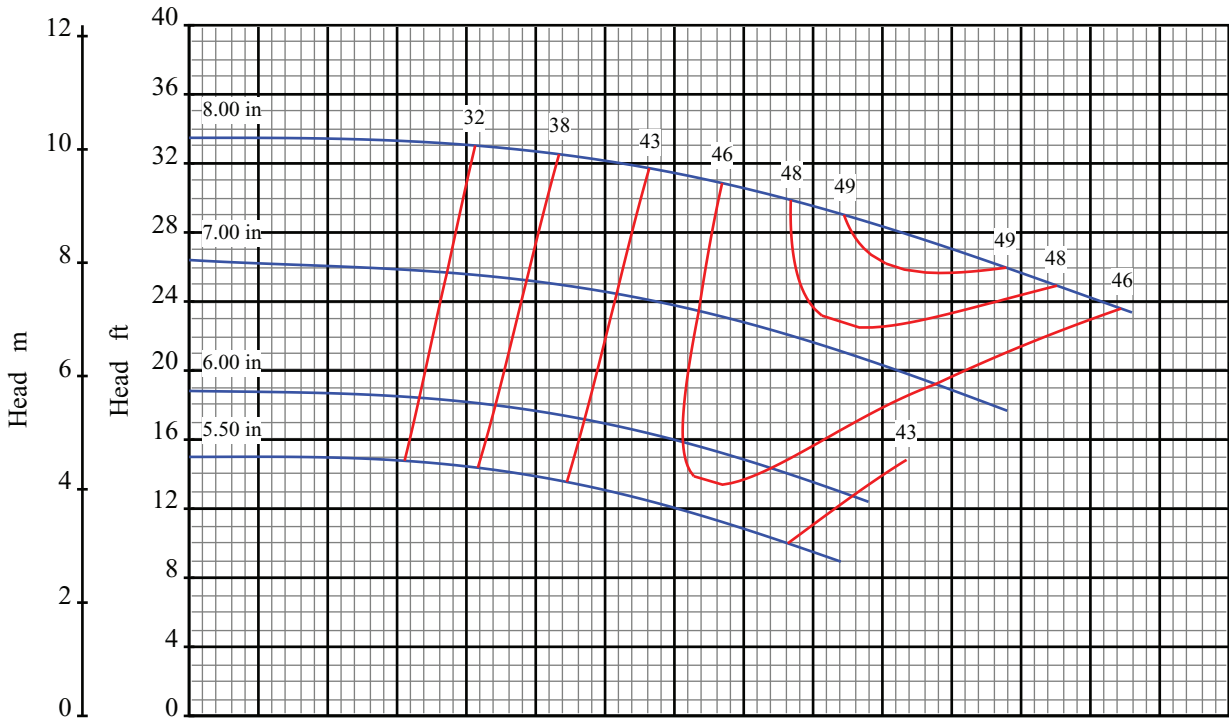

Curve No: S18116V1

Blackmer Centrifugal

Pump Size: 1x1.5 8

Pump Performance Characteristics

Effective Date: Jan/2005

Catalog: 1301

Speed: 1150 rpm

Open Impeller

Blackmer® Centrifugal Composite Pump Curves | Frame S

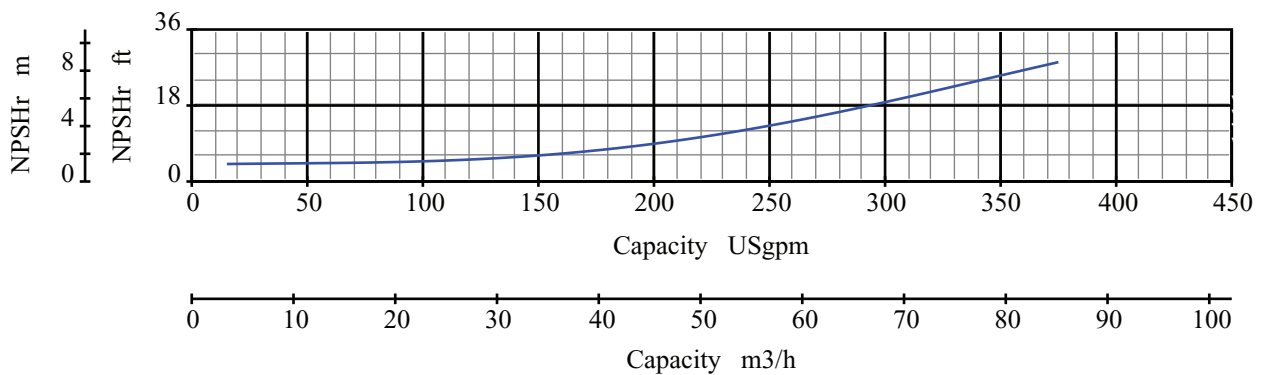
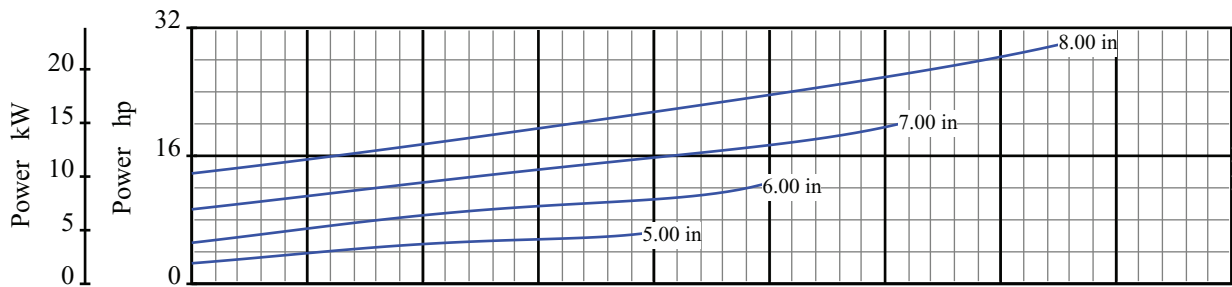
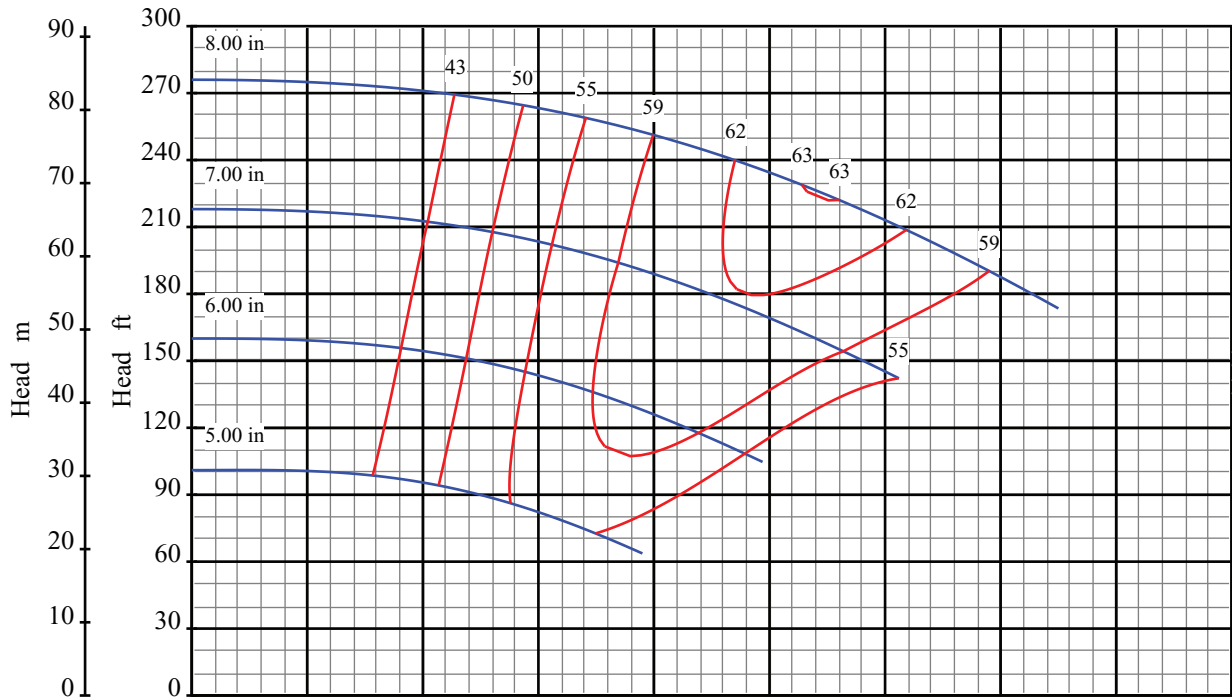

Curve No: S18118V1

Blackmer Centrifugal

Pump Size: 1.5x3 8

Pump Performance Characteristics

Effective Date: Jan/2005

Catalog: 1301

Speed: 3550 rpm

Open Impeller

Blackmer® Centrifugal Composite Pump Curves | Frame S

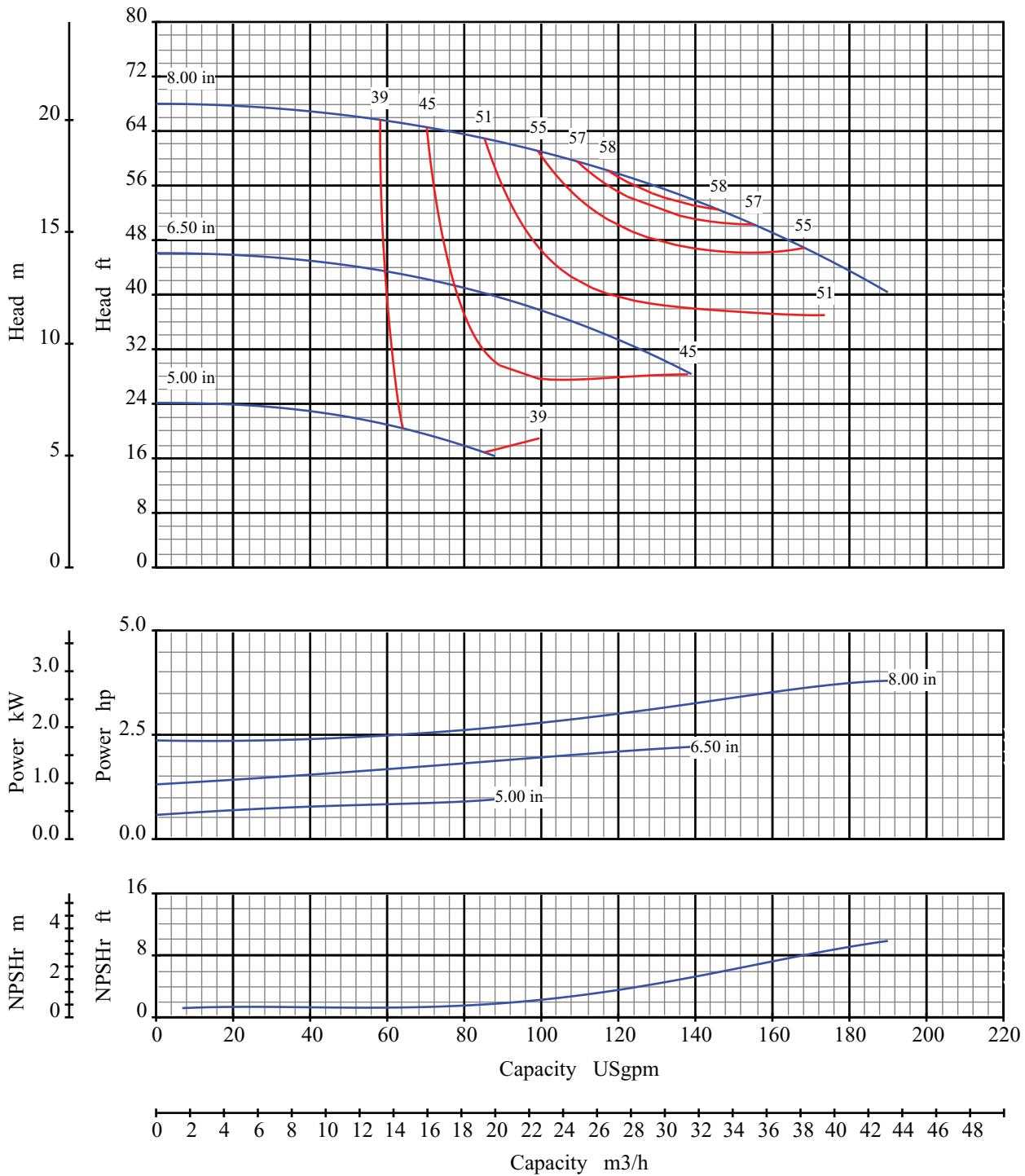

Curve No: S18120V1

Blackmer Centrifugal

Pump Size: 1.5x3 8

Pump Performance Characteristics

Effective Date: Jan/2005

Catalog: 1301

Speed: 1750 rpm

Open Impeller

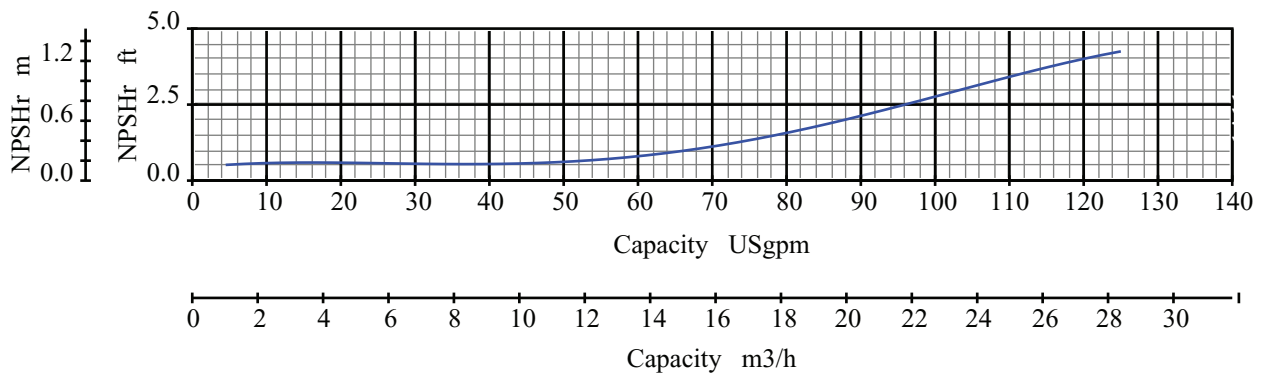
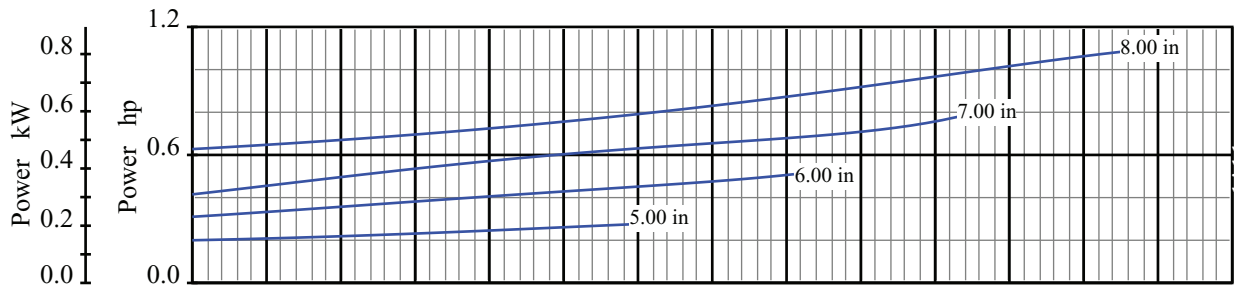
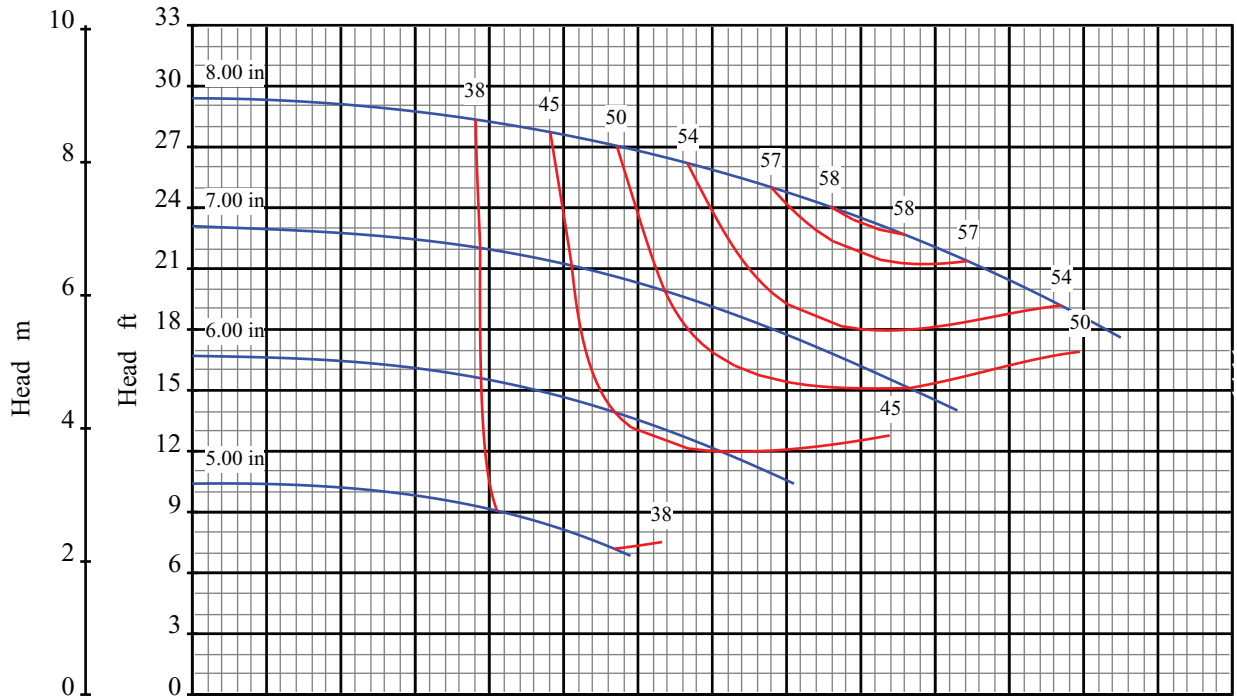

Curve No: S18122V1

Blackmer Centrifugal

Pump Size: 1.5x3 8

Pump Performance Characteristics

Effective Date: Jan/2005

Catalog: 1301

Speed: 1150 rpm

Open Impeller

Blackmer® Centrifugal Composite Pump Curves | Frame S

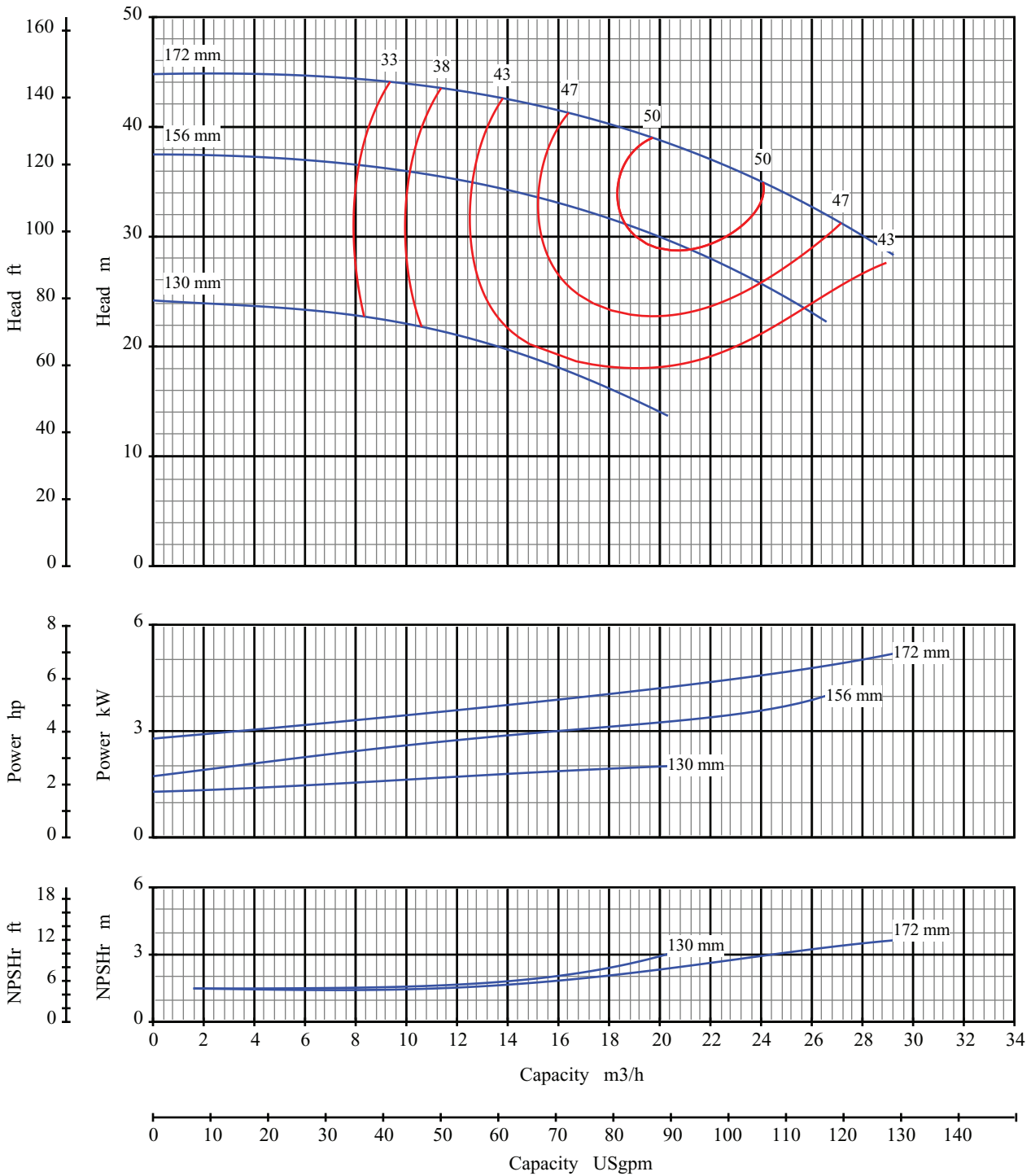

Curve No: S18125V1

Blackmer Centrifugal

Pump Size: 32x50 160

Pump Performance Characteristics

Effective Date: Jan/2005

Catalog: 1301

Speed: 2900 rpm

Open Impeller

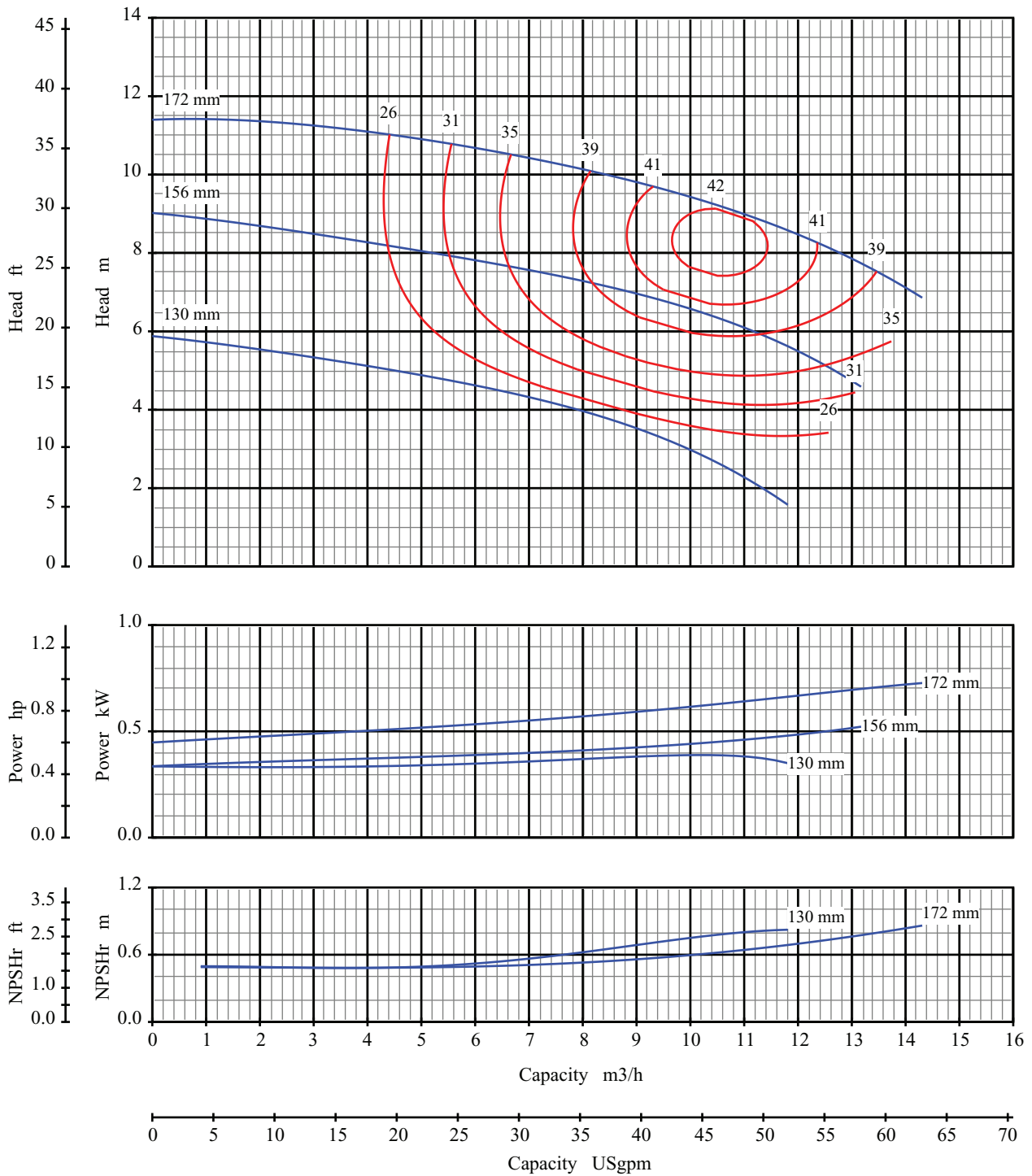

Curve No: S18127V1

Blackmer Centrifugal

Pump Size: 32x50 160

Pump Performance Characteristics

Effective Date: Jan/2005

Catalog: 1301

Speed: 1450 rpm

Open Impeller

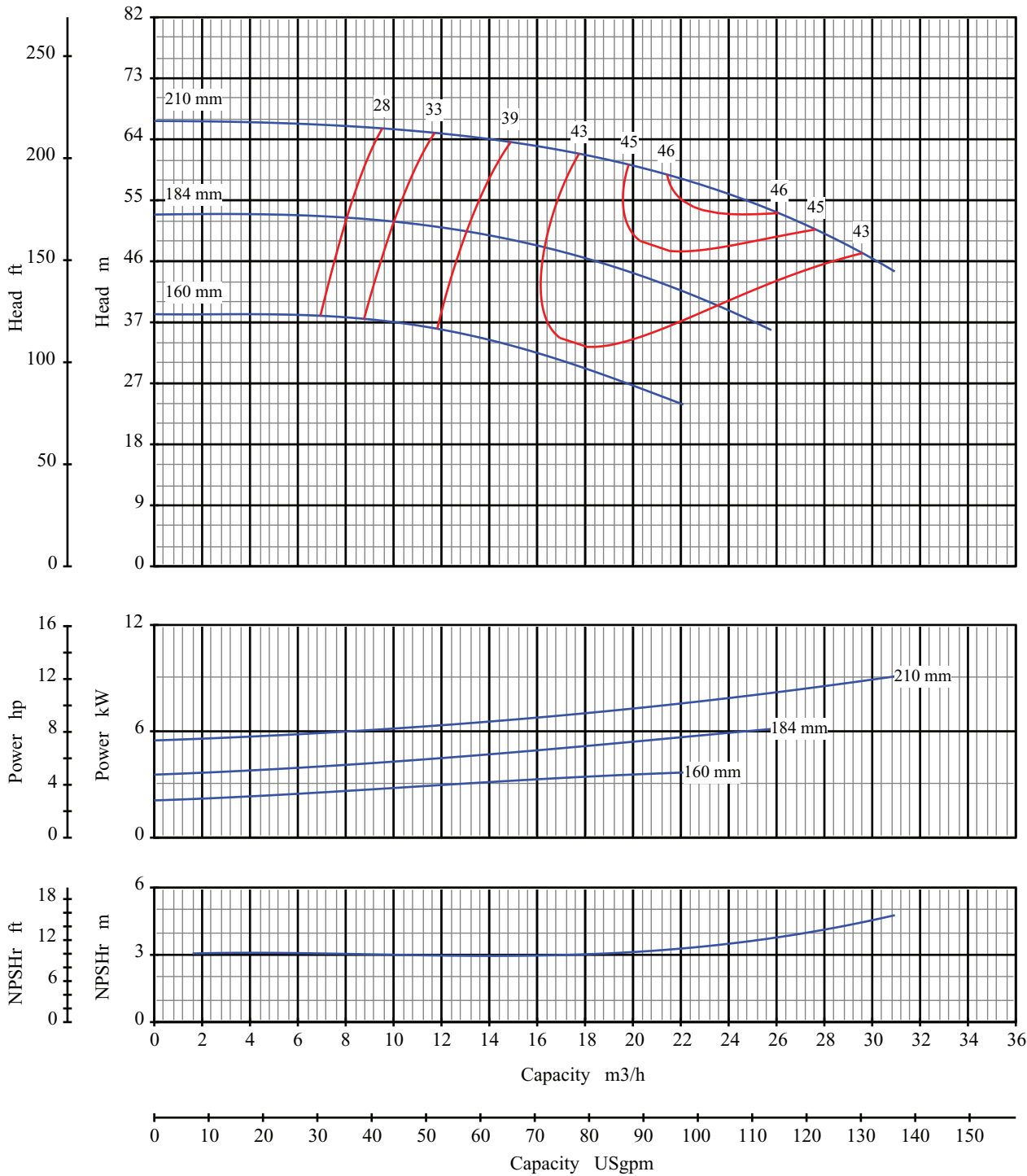

Curve No: S18131V1

Blackmer Centrifugal

Pump Size: 32x50 200

Pump Performance Characteristics

Effective Date: Jan/2005

Catalog: 1301

Speed: 2900 rpm

Open Impeller

Blackmer® Centrifugal Composite Pump Curves | Frame S

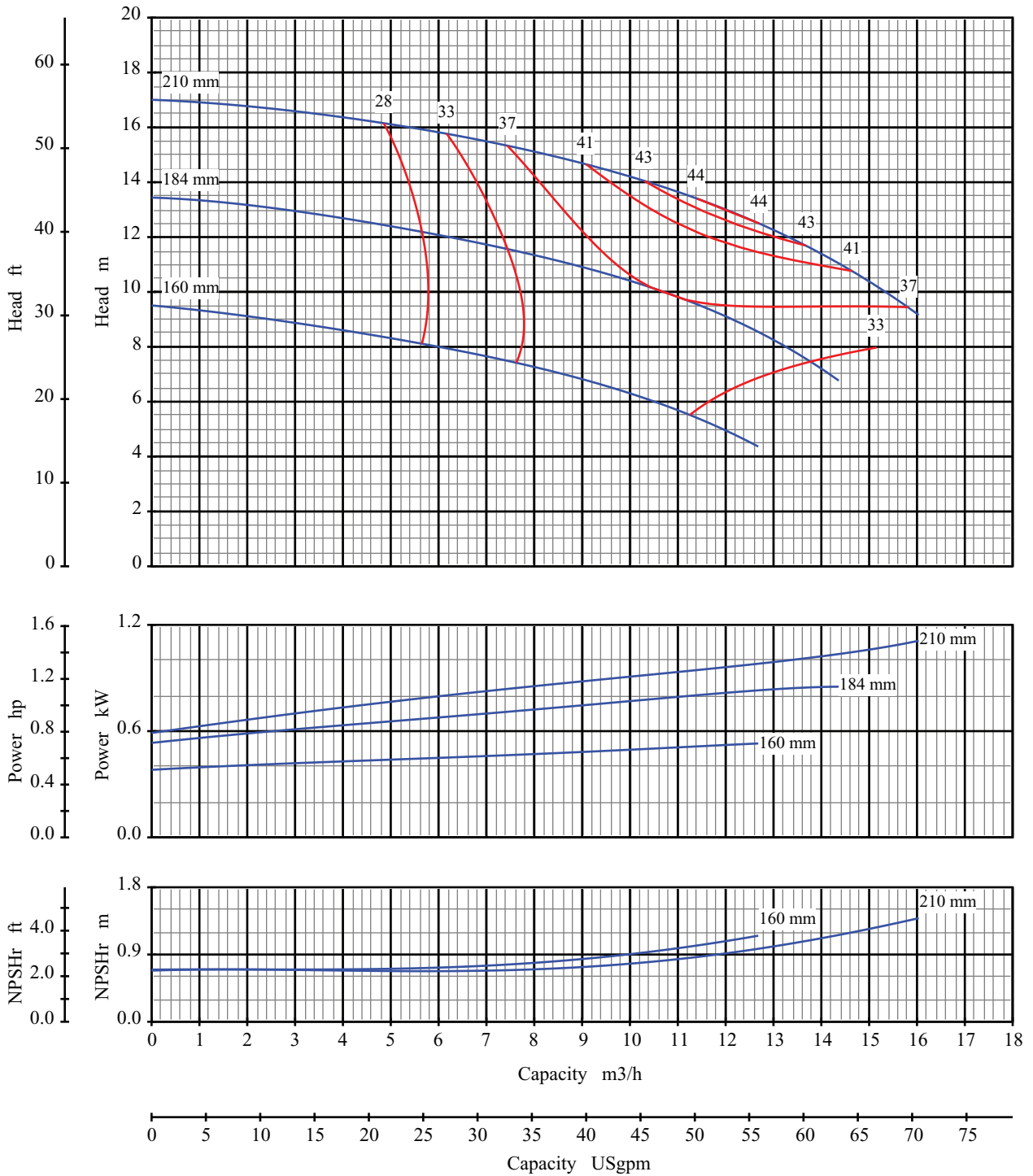

Curve No: S18133V1

Blackmer Centrifugal

Pump Size: 32x50 200

Pump Performance Characteristics

Effective Date: Jan/2005

Catalog: 1301

Speed: 1450 rpm

Open Impeller

Blackmer® Centrifugal Composite Pump Curves | Frame S

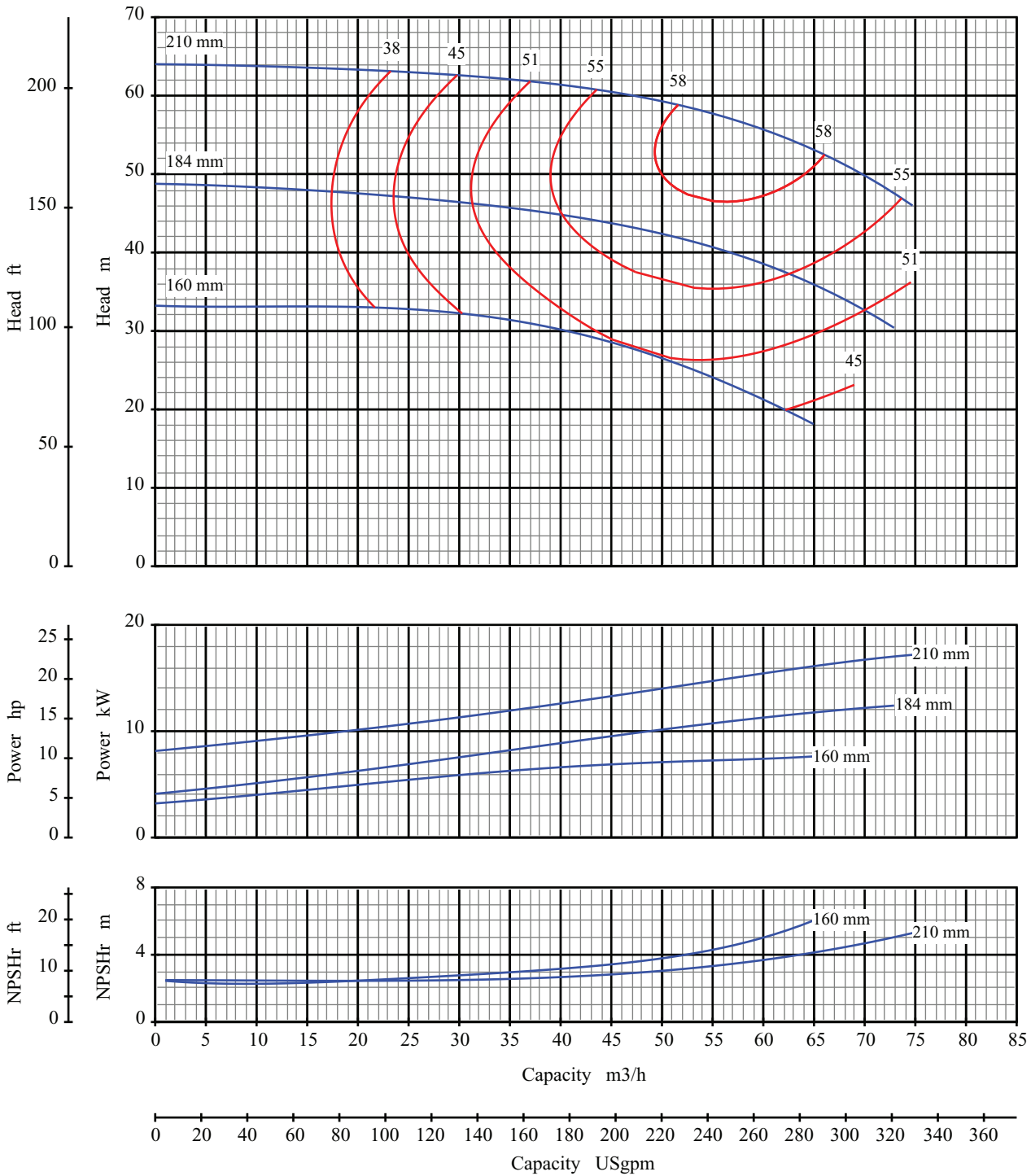

Curve No: S18137V1

Blackmer Centrifugal

Pump Size: 50x80 200

Pump Performance Characteristics

Effective Date: Jan/2005

Catalog: 1301

Speed: 2900 rpm

Open Impeller

Blackmer® Centrifugal Composite Pump Curves | Frame S

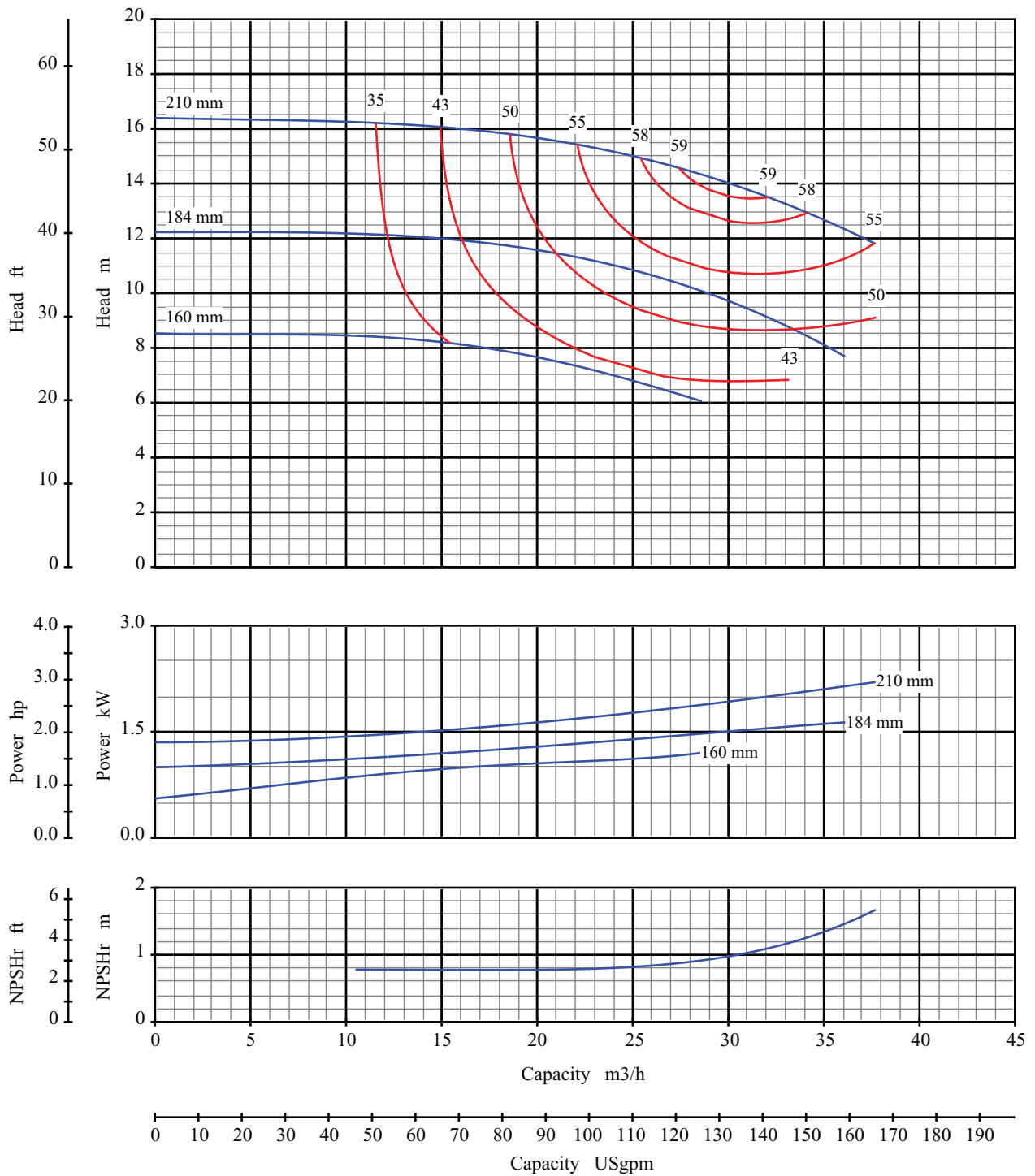

Curve No: S18139V1

Blackmer Centrifugal

Pump Size: 50x80 200

Pump Performance Characteristics

Effective Date: Jan/2005

Catalog: 1301

Speed: 1450 rpm

Open Impeller

Blackmer® Centrifugal Composite Pump Curves | Frame S

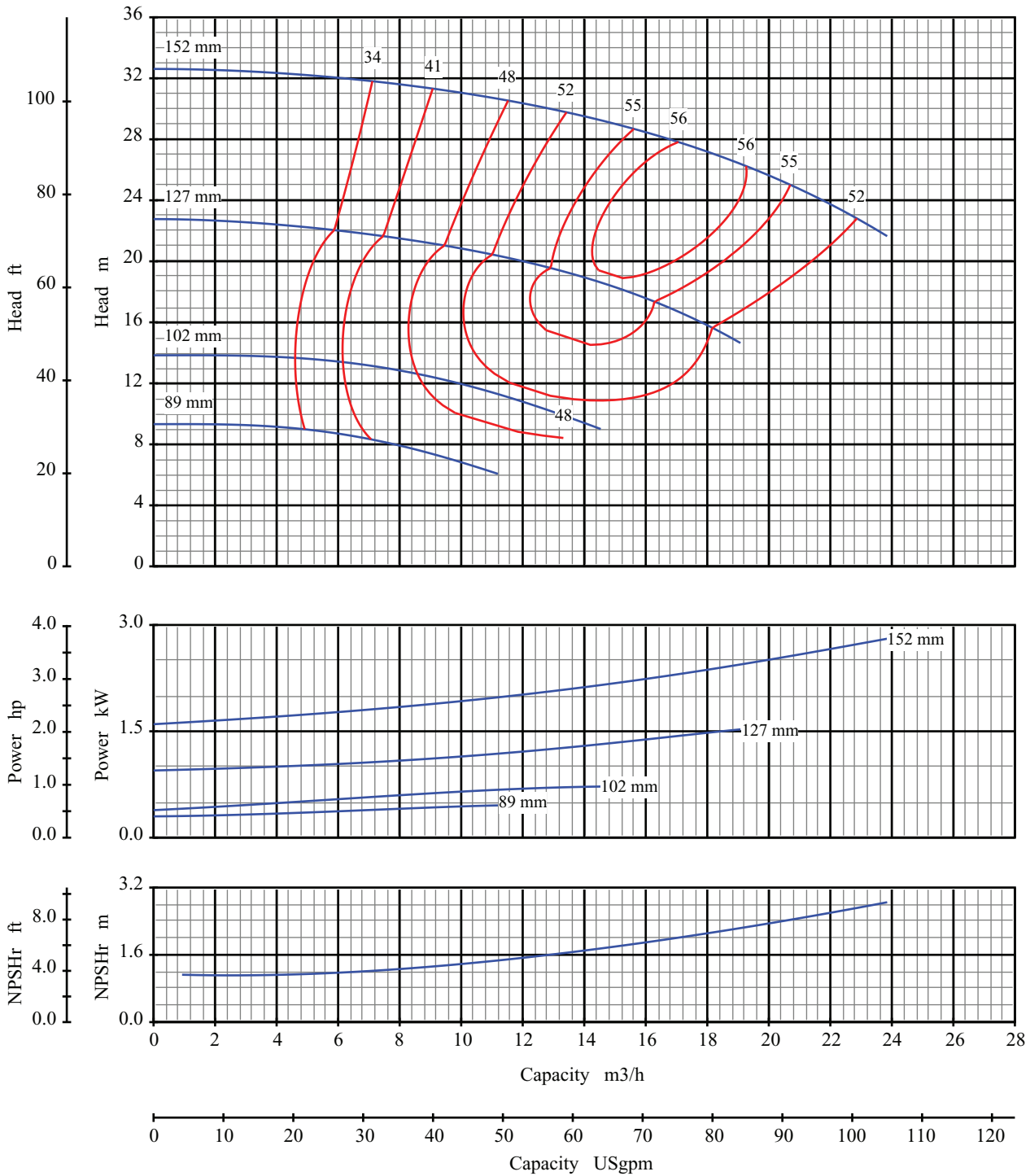

Curve No: S18101V1

Blackmer Centrifugal

Pump Size: 1x1.5 6

Pump Performance Characteristics

Effective Date: Jan/2005

Catalog: 1301

Speed: 2900 rpm

Open Impeller

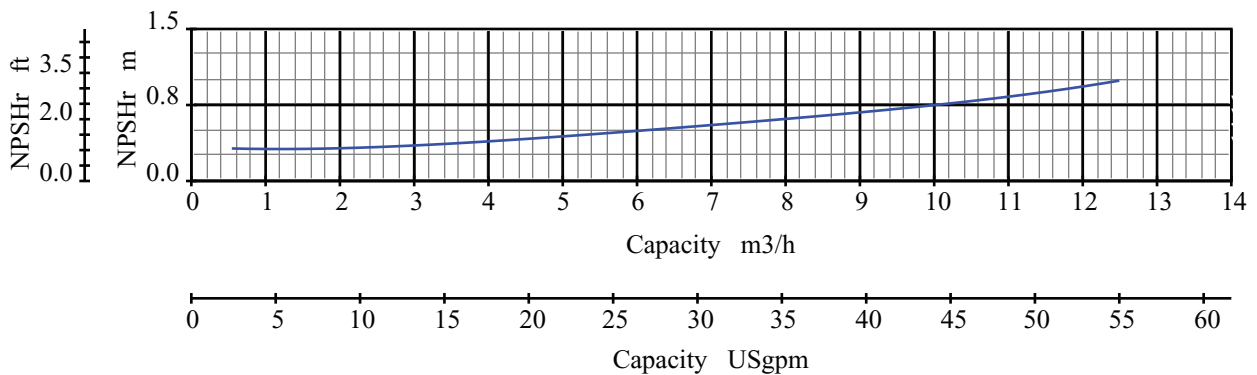
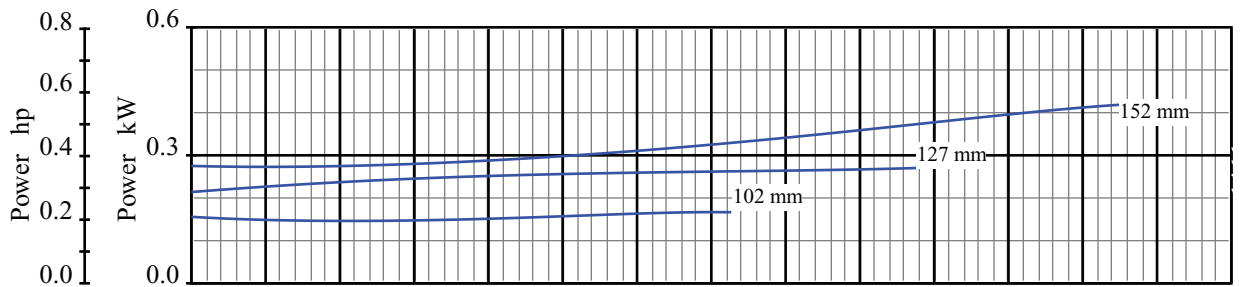
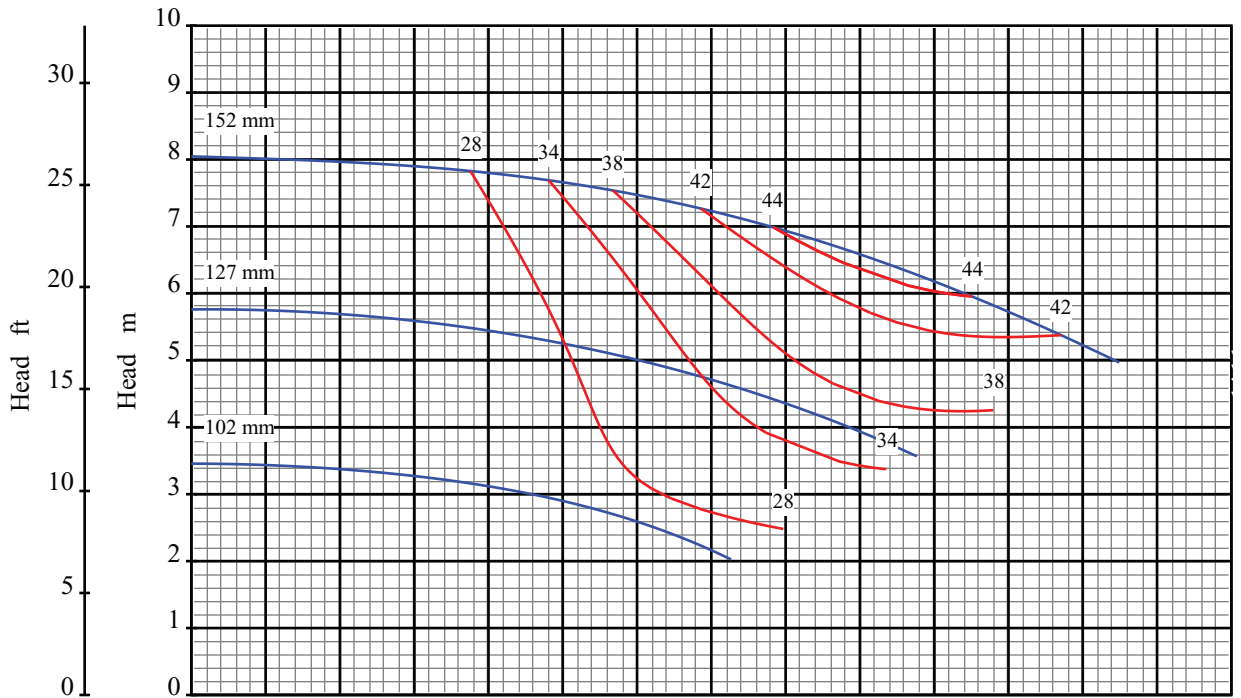

Curve No: S18103V1

Blackmer Centrifugal

Pump Size: 1x1.5 6

Pump Performance Characteristics

Effective Date: Jan/2005

Catalog: 1301

Speed: 1450 rpm

Open Impeller

Blackmer® Centrifugal Composite Pump Curves | Frame S

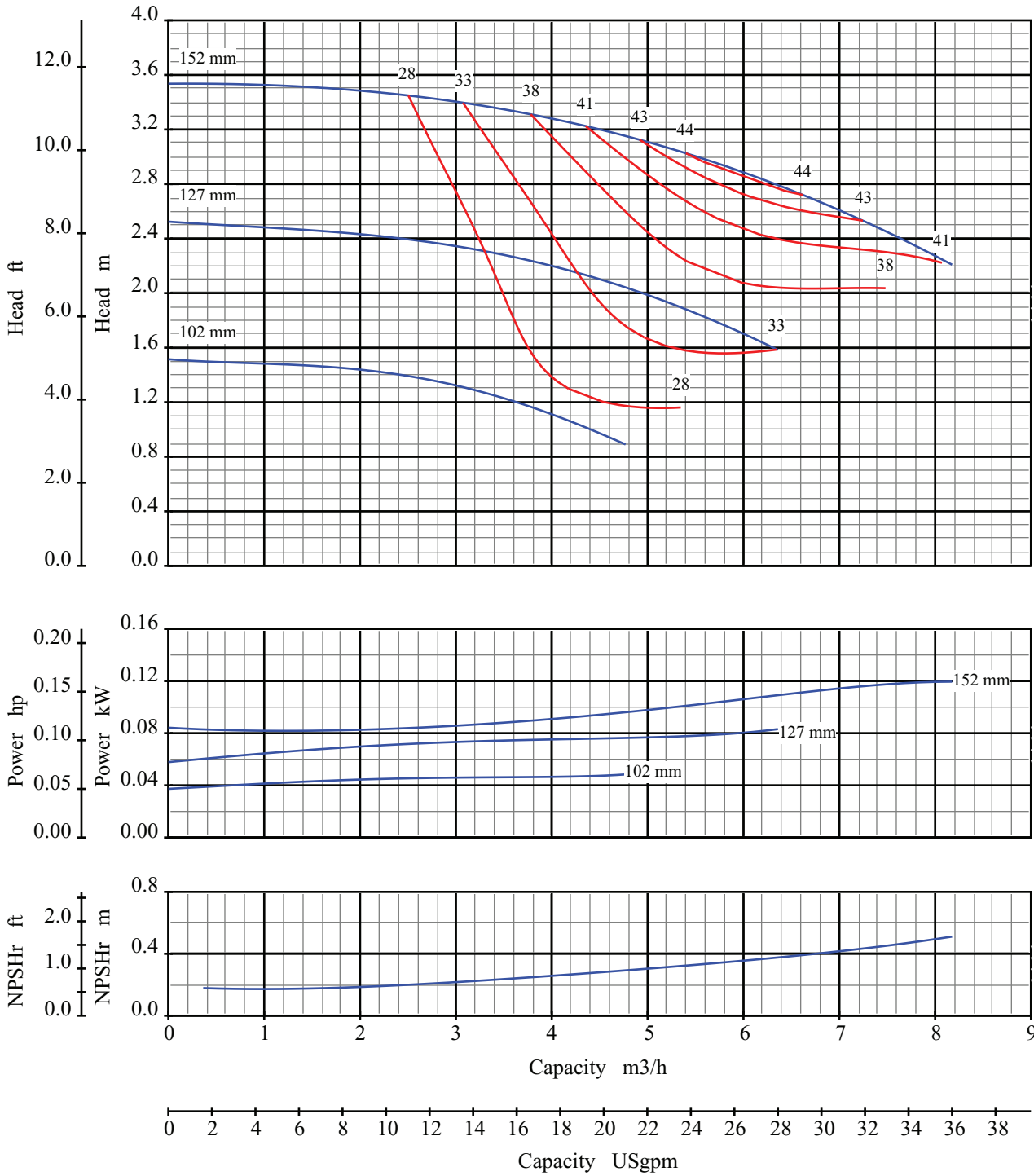

Curve No: S18105V1

Blackmer Centrifugal

Pump Size: 1x1.5 6

Pump Performance Characteristics

Effective Date: Jan/2005

Catalog: 1301

Speed: 960 rpm

Open Impeller

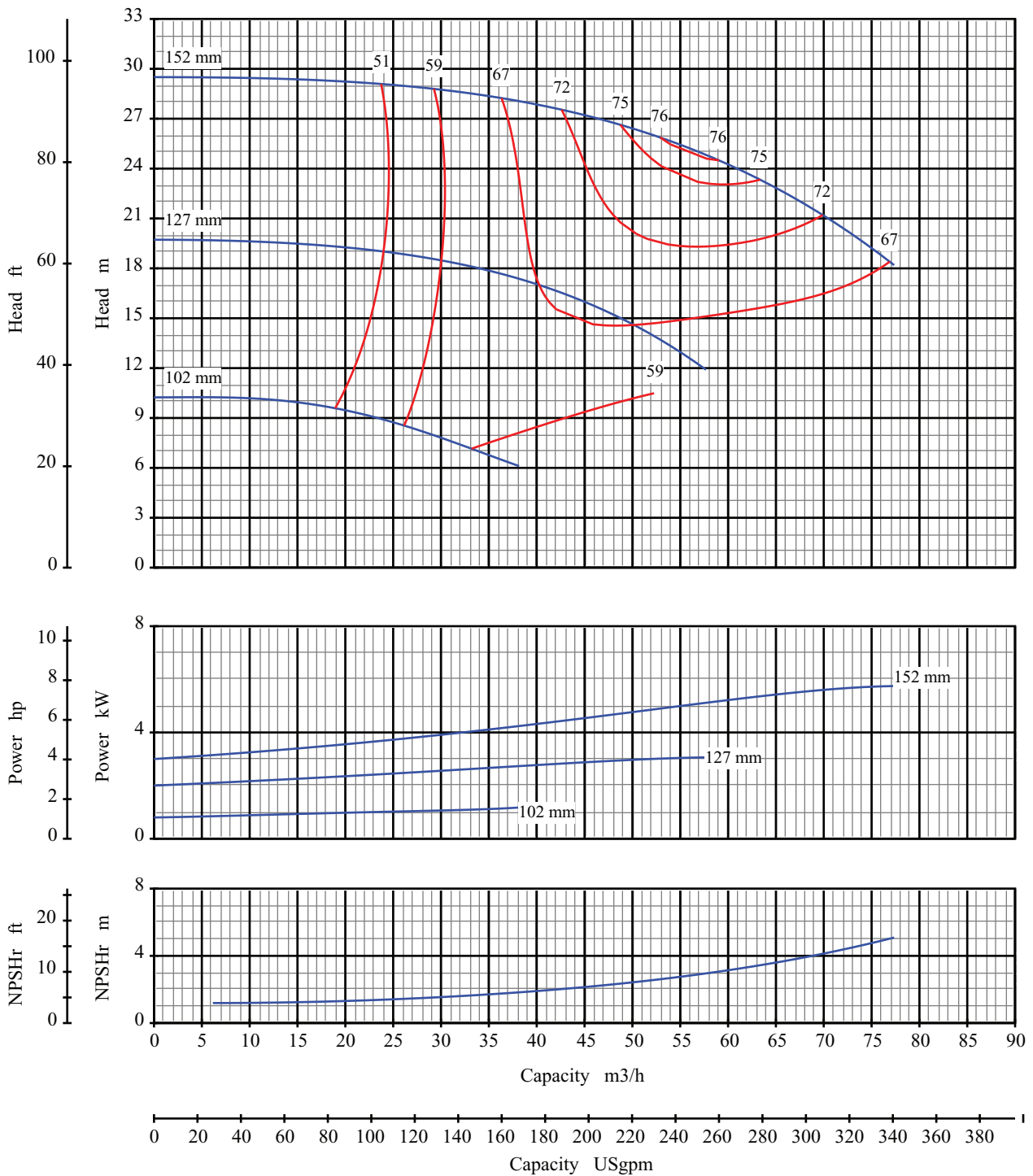

Curve No: S18107V1

Blackmer Centrifugal

Pump Size: 2x3 6

Pump Performance Characteristics

Effective Date: Jan/2005

Catalog: 1301

Speed: 2900 rpm

Open Impeller

Blackmer® Centrifugal Composite Pump Curves | Frame S

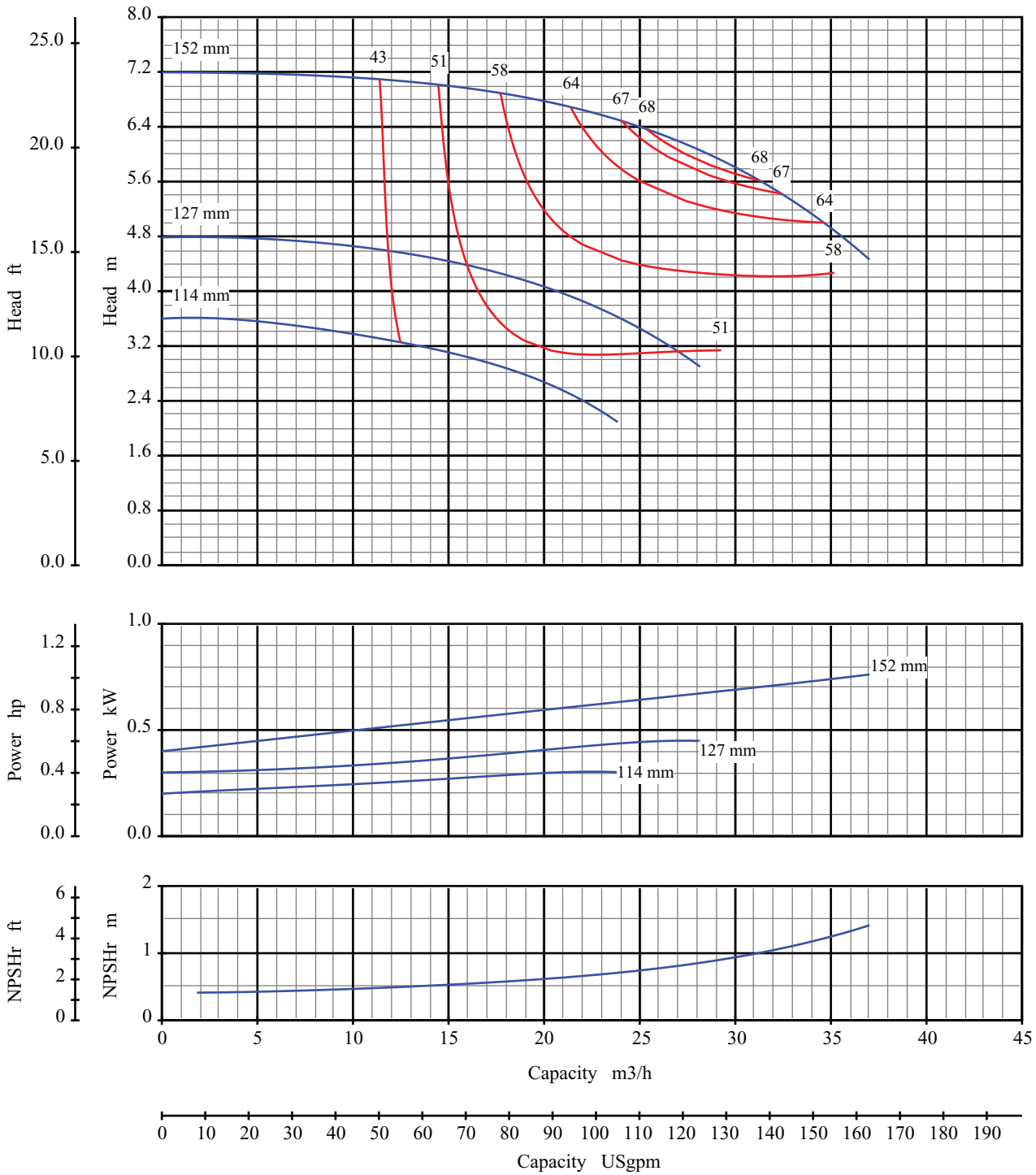

Curve No: S18109V1

Blackmer Centrifugal

Pump Size: 2x3 6

Pump Performance Characteristics

Effective Date: Jan/2005

Catalog: 1301

Speed: 1450 rpm

Open Impeller

Blackmer® Centrifugal Composite Pump Curves | Frame S

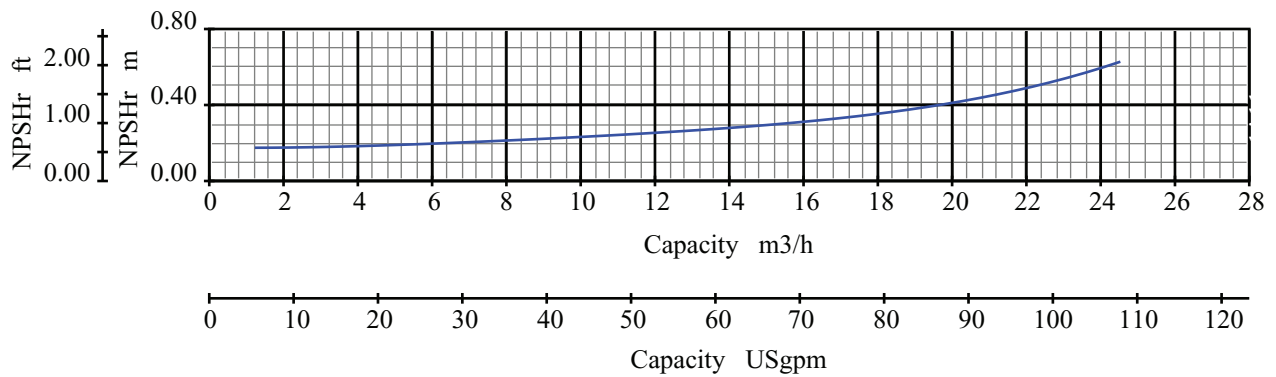
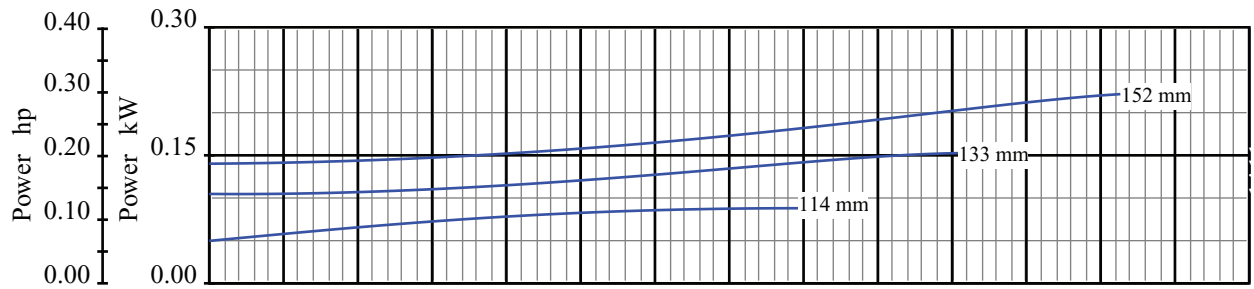
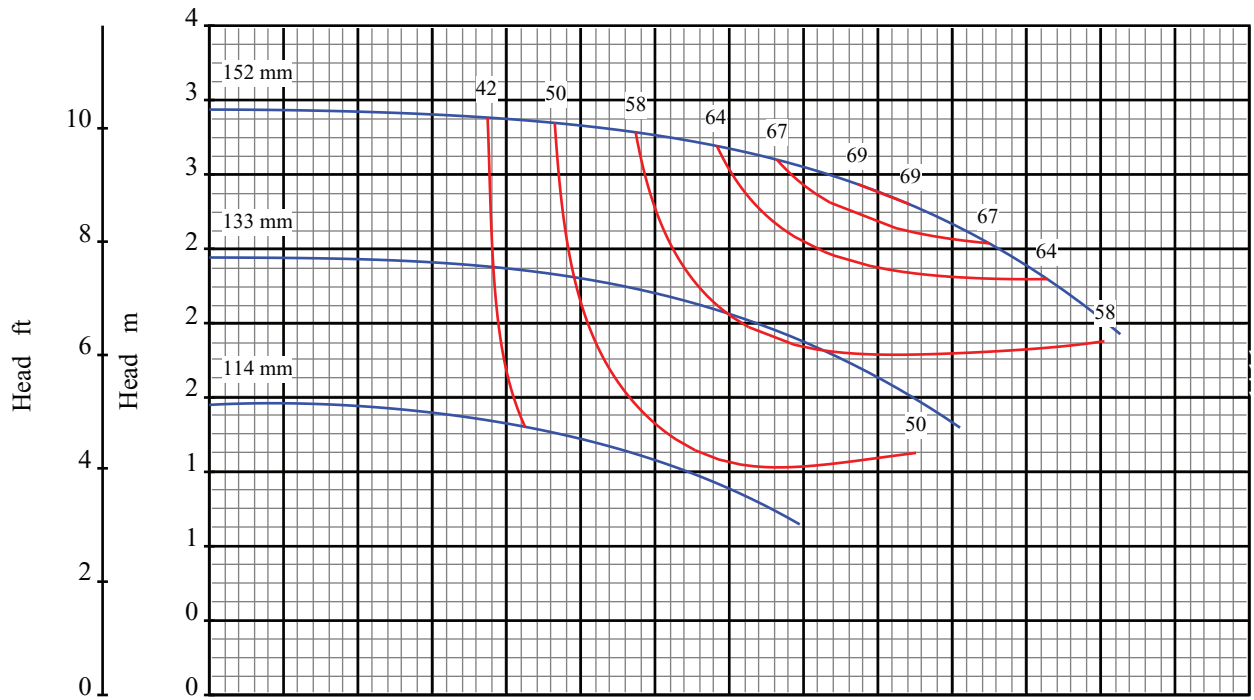

Curve No: S1811V1

Blackmer Centrifugal

Pump Size: 2x3 6

Pump Performance Characteristics

Effective Date: Jan/2005

Catalog: 1301

Speed: 960 rpm

Open Impeller

Blackmer® Centrifugal Composite Pump Curves | Frame S

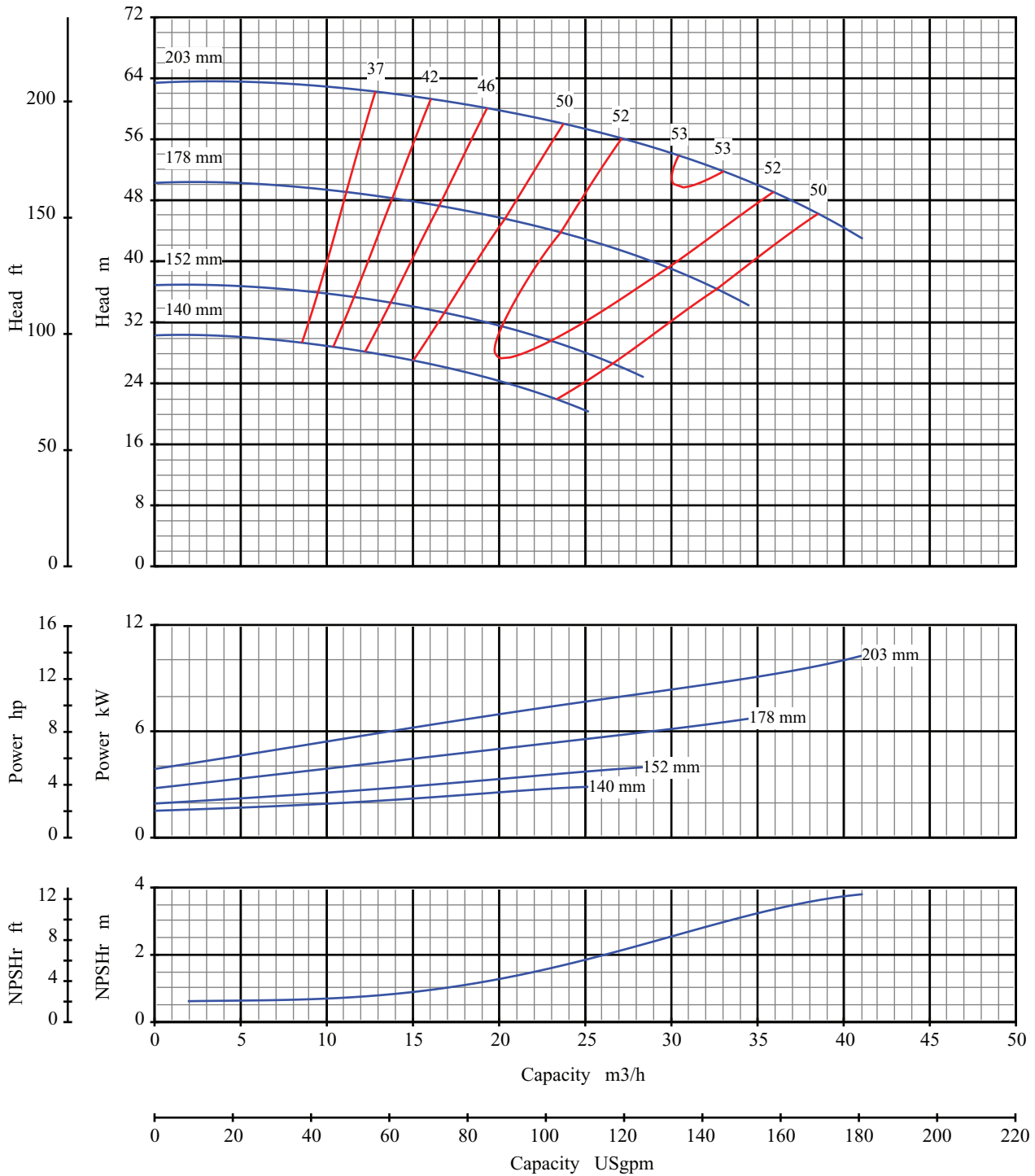

Curve No: S18113V1

Blackmer Centrifugal

Pump Size: 1x1.5 8

Pump Performance Characteristics

Effective Date: Jan/2005

Catalog: 1301

Speed: 2900 rpm

Open Impeller

Blackmer® Centrifugal Composite Pump Curves | Frame S

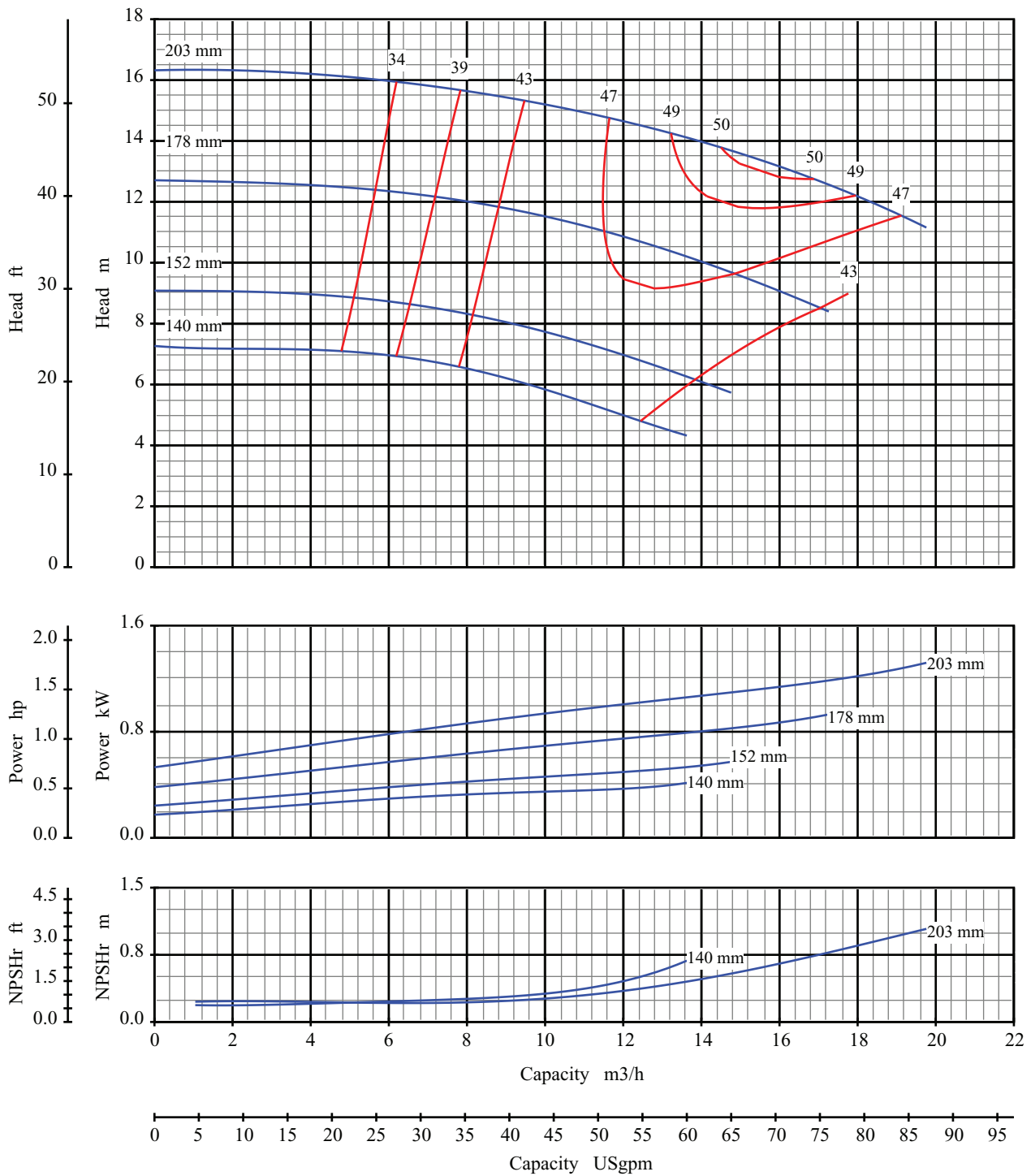

Curve No: S18115V1

Blackmer Centrifugal

Pump Size: 1x1.5 8

Pump Performance Characteristics

Effective Date: Jan/2005

Catalog: 1301

Speed: 1450 rpm

Open Impeller

Blackmer® Centrifugal Composite Pump Curves | Frame S

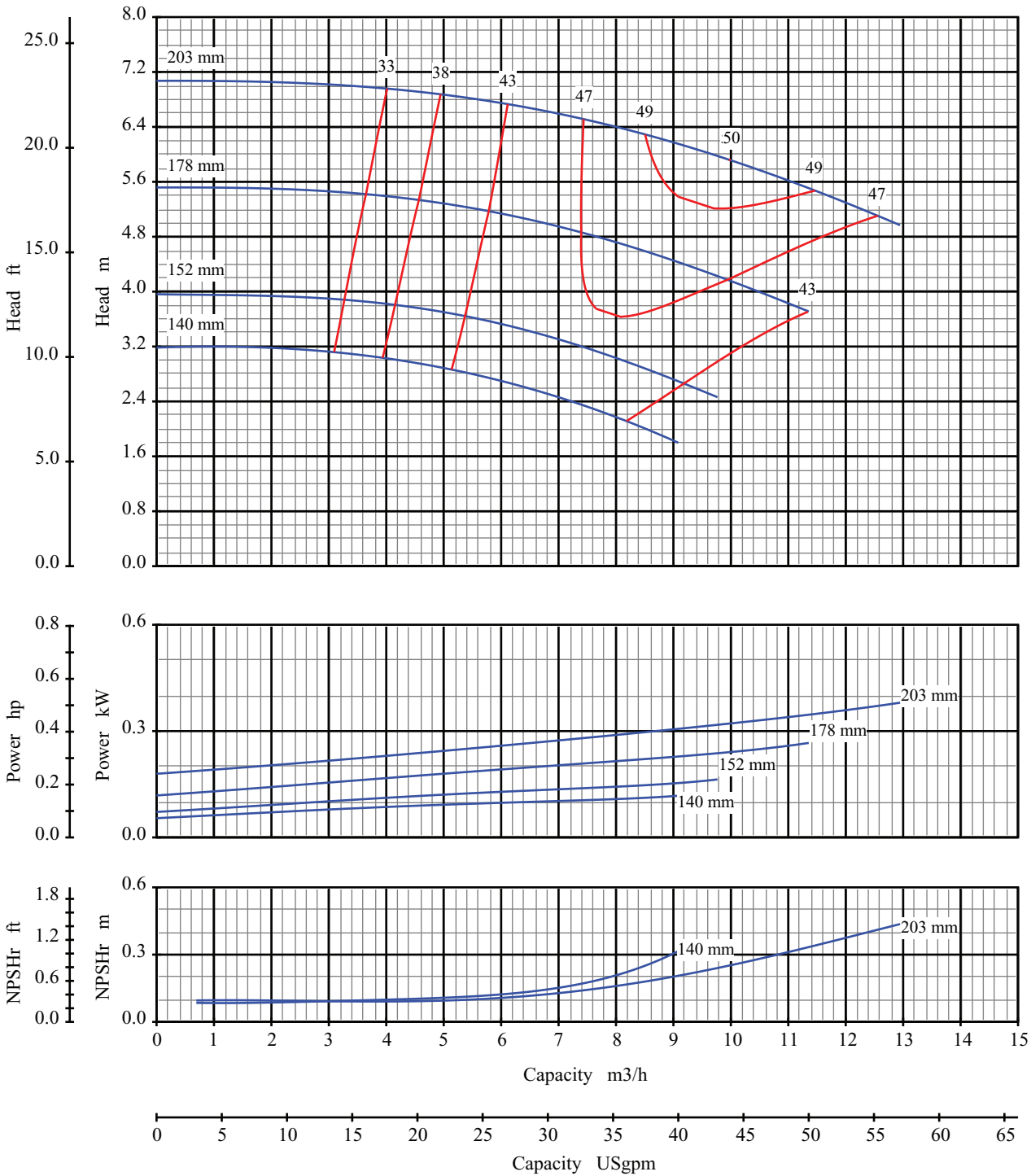

Curve No: S18117V1

Blackmer Centrifugal

Pump Size: 1x1.5 8

Pump Performance Characteristics

Effective Date: Jan/2005

Catalog: 1301

Speed: 960 rpm

Open Impeller

Blackmer® Centrifugal Composite Pump Curves | Frame S

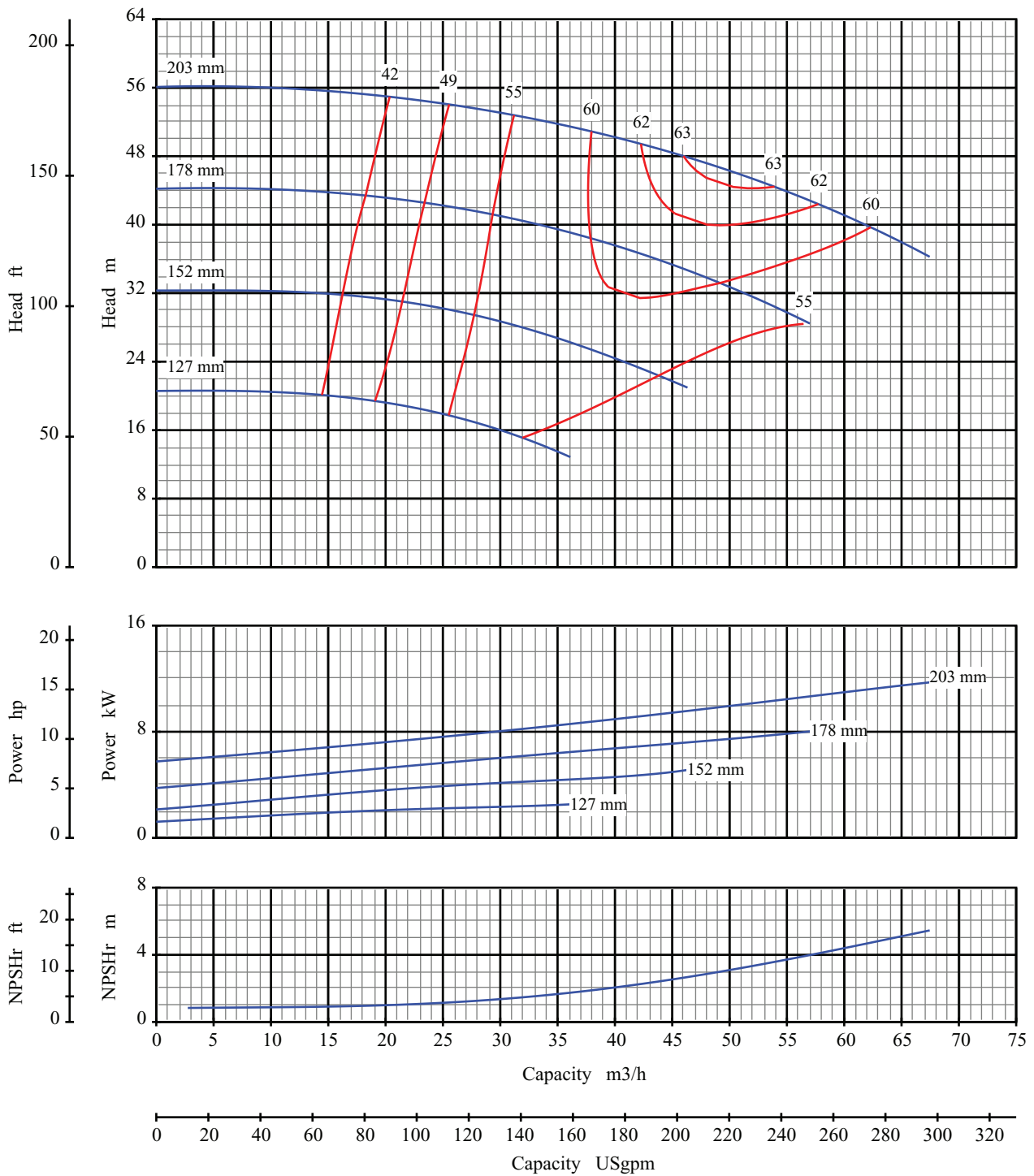

Curve No: S18119V1

Blackmer Centrifugal

Pump Size: 1.5x3 8

Pump Performance Characteristics

Effective Date: Jan/2005

Catalog: 1301

Speed: 2900 rpm

Open Impeller

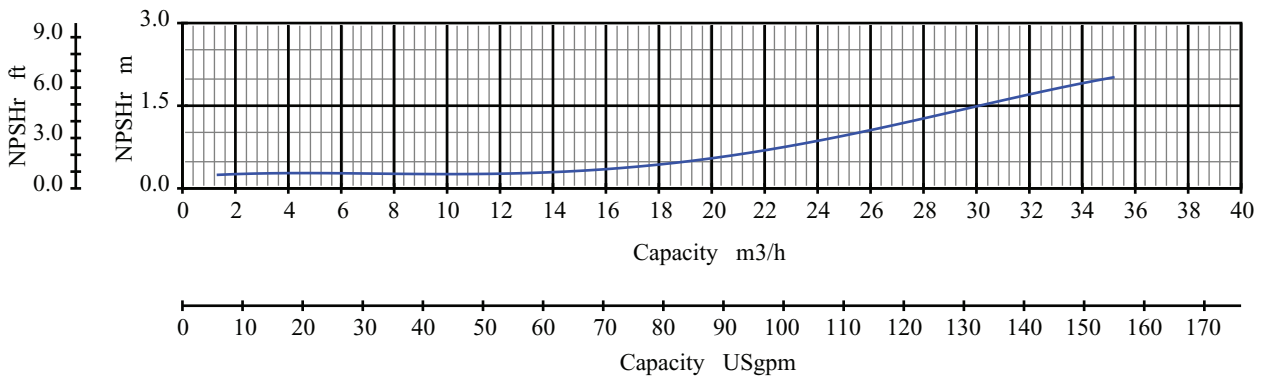
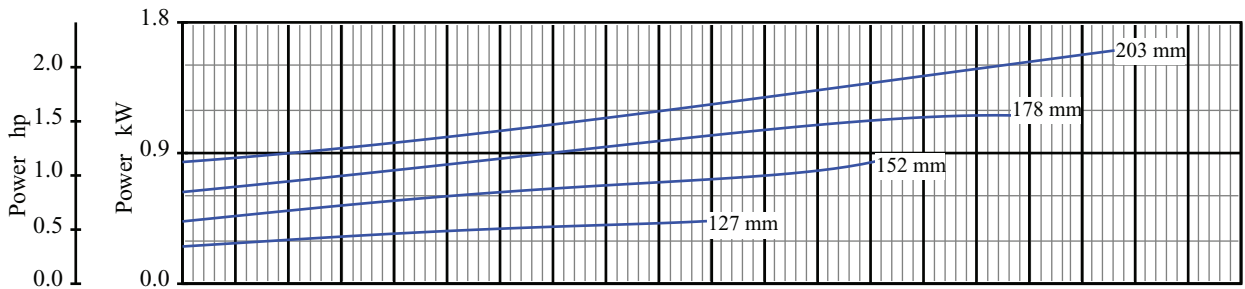
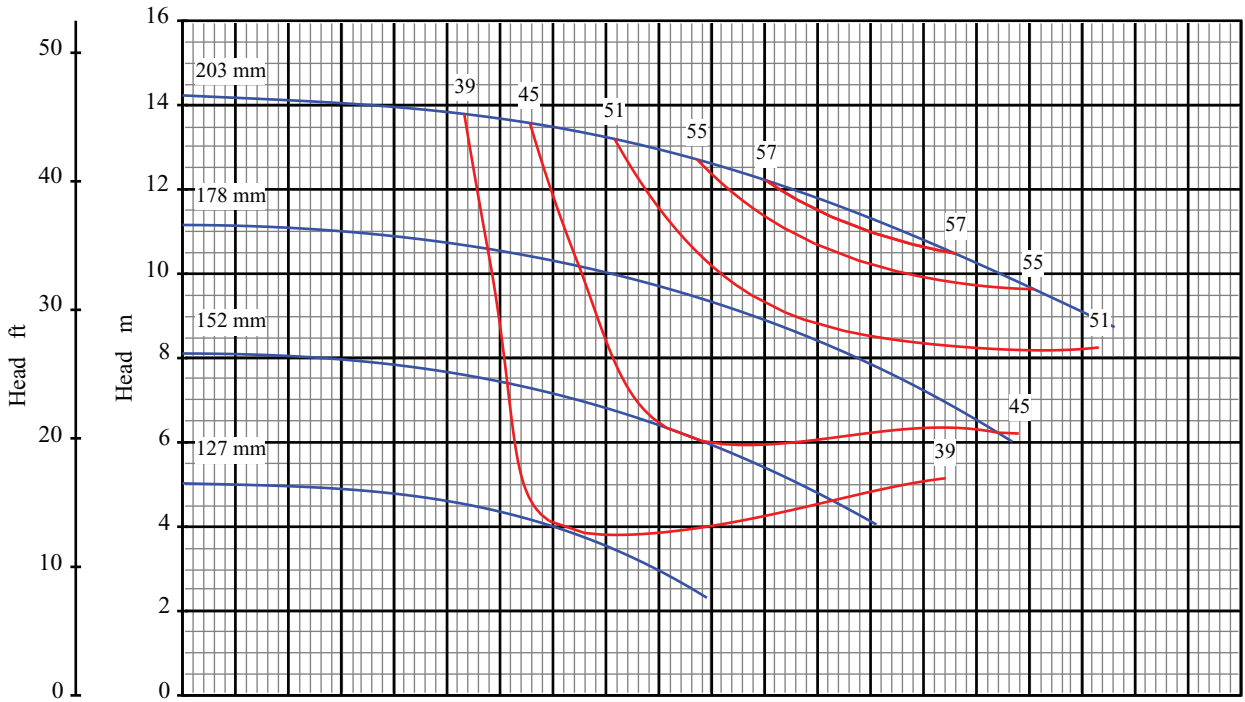

Curve No: S18121V1

Blackmer Centrifugal

Pump Size: 1.5x3 8

Pump Performance Characteristics

Effective Date: Jan/2005

Catalog: 1301

Speed: 1450 rpm

Open Impeller

Blackmer® Centrifugal Composite Pump Curves | Frame S

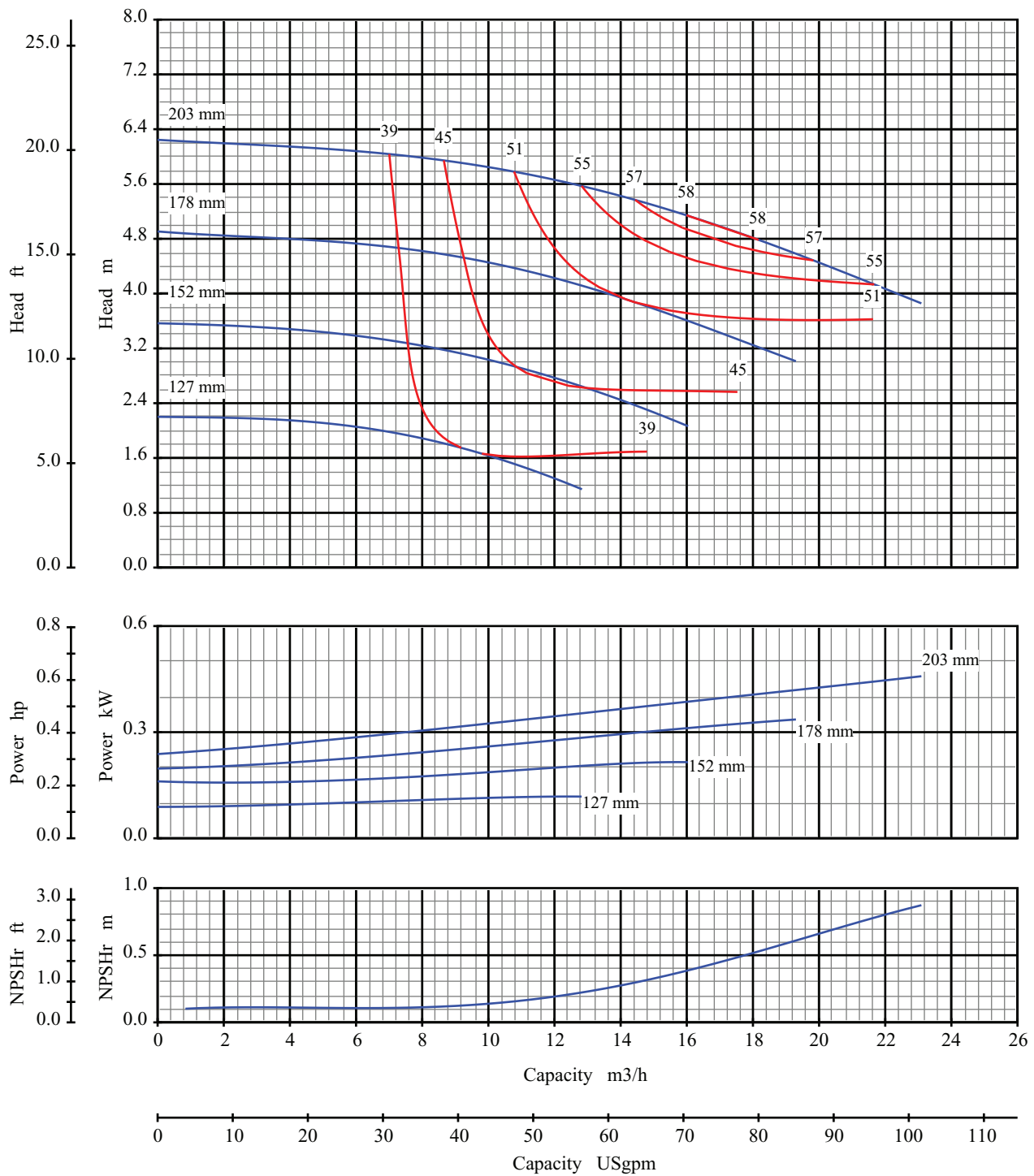

Curve No: S18123V1

Blackmer Centrifugal

Pump Size: 1.5x3 8

Pump Performance Characteristics

Effective Date: Jan/2005

Catalog: 1301

Speed: 960 rpm

Open Impeller

Blackmer® Centrifugal Pumps | Product Line

Frame A/LD17 Pump

- LD17 configuration available for severe duty applications
- Lowest L3/D4 stiffness ratio of any competitive size pump 17 (.65) Frame LD17
- Frame A meets ASME/ANSI dimensional specifications

- Capacities up to 1,400 gpm (320 m³/hr)
- Operating temperature range from -40° to 400°F (-40° to 204°C)
- Military shock standard S901 Grade A
- High Temperature Series configurations available with some Frame A/LD17 sizes



Frame A/LD17 (ASME/ANSI)

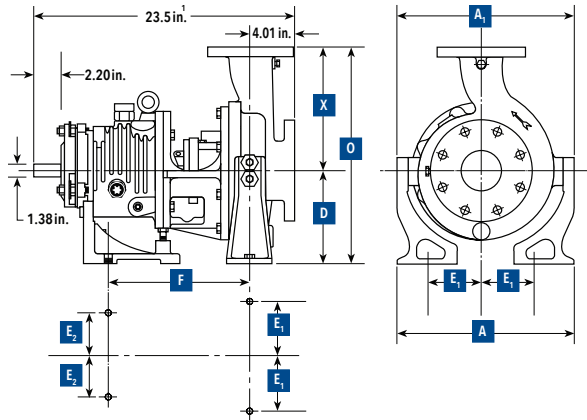

Frame A/LD17 (Metric)

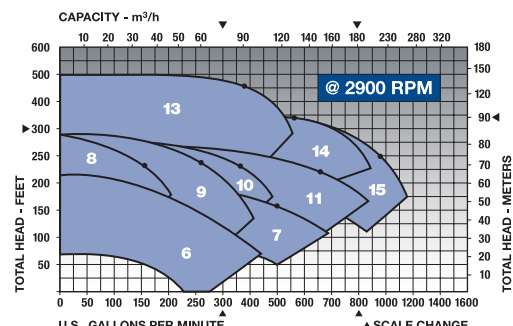
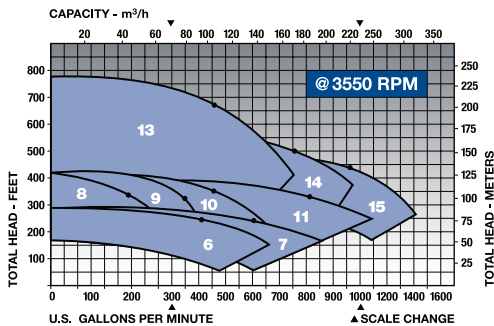
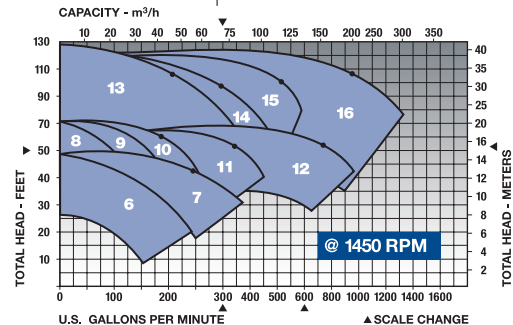
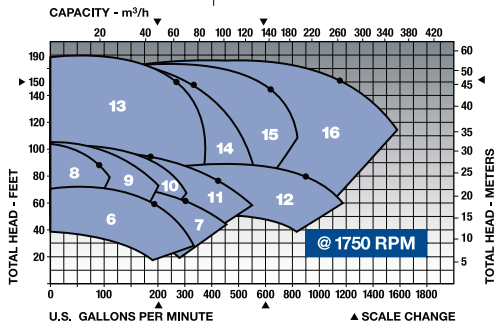
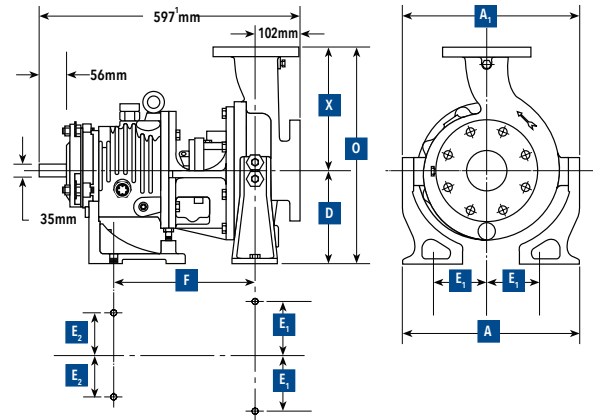

LD17 Pump - ASME/ANSI

Pump Size	Discharge	Suction	X	D	O	F	2E ₁	2E ₂	A	A ₁
6	2 x 3-8	2.0	3.0	9.50	8.25	17.75	9.81	9.75	7.25	15.00
7	3 x 4-8	3.0	4.0	11.00	8.25	19.25	9.81	9.75	7.25	15.75
8	1 x 2-10	1.0	2.0	8.50	8.25	16.75	9.81	9.75	7.25	15.75
9	1.5 x 3-10	1.5	3.0	8.50	8.25	16.75	9.81	9.75	7.25	16.13
10	2 x 3-10	2.0	3.0	9.50	8.25	17.75	9.81	9.75	7.25	16.38
11	3 x 4-10	3.0	4.0	11.10	8.25	19.25	9.81	9.75	7.25	13.63
12	4 x 6-10	4.0	6.0	13.50	10.00	23.50	9.81	9.75	7.25	14.44
13	1.5 x 3-13	1.5	3.0	10.50	10.00	20.50	9.81	9.75	7.25	15.00
14	2 x 3-13	2.0	3.0	11.50	10.00	21.50	9.81	9.75	7.25	15.38
15	3 x 4-13	3.0	4.0	12.50	10.00	22.50	9.81	13.00	7.25	16.63
16	4 x 6-13	4.0	6.0	13.50	10.00	23.50	9.81	13.00	7.25	17.56

All dimensions are in inches.

LD17 Pump - Metric

Pump Size	Discharge	Suction	X	D	O	F	2E ₁	2E ₂	A	A ₁
6	2 x 3-8	50	80	241	200	441	249	250	184	279
7	3 x 4-8	80	100	279	200	479	249	250	184	298
8	1 x 2-10	25	50	216	200	416	249	250	184	298
9	1.5 x 3-10	40	80	216	200	416	249	250	184	318
10	2 x 3-10	50	80	241	200	441	249	250	184	314
11	3 x 4-10	80	100	279	200	479	249	250	184	346
12	4 x 6-10	100	150	343	250	593	249	250	184	367
13	1.5 x 3-13	40	80	267	250	517	249	250	184	381
14	2 x 3-13	50	80	292	250	542	249	250	184	391
15	3 x 4-13	80	100	318	250	568	249	330	184	422
16	4 x 6-13	100	150	343	250	593	249	330	184	460

All dimensions are in millimeters.

Blackmer® Centrifugal Design Data | Frame A/LD17

Blackmer® Centrifugal Pumps Design Data Frame LD17

Inches (mm)

	2.0 x 3.0-08	3.0 x 4.0-08	1.0 x 2.0-10	1.5 x 3.0-10	2.0 x 3.0-10	3.0 x 4.0-10	4.0 x 6.0-10	1.5 x 3.0-13	2.0 x 3.0-13	3.0 x 4.0-13	4.0 x 6.0-13
Shaft											
L3/D4 Ratio	17 (.65)										
Diameter at Impeller	1.06 (27) 1.00-12 UNF Thread High Torque 1.31 (33) 1.25-12 UNF Thread										
Diameter at Seal	1.875 (47.63)										
Diameter Between Bearings	2.45 (62)										
Diameter at Coupling	1.375 (34.93)										
Bearings											
Thrust	SKF 7310 BEGAY (pair)										
Radial	6310 C3										
Bearing Span	6.02 (153)										
Shaft Overhang	5.94 (151)										
Seal Chamber											
Seal Bore Diameter (nose)	2.69 (68) nose										
Inside Bore	3.00 (76)										
Depth	2.00 (51)										
Back Cover/Shaft Clearance	Open 5 Degree Taper										
Gland Bolting ANSI	4X .500-13UNC on 4.62 B.C. (12 on 117 B.C.)										
Distance to Nearest Obstruction	2.19 (56)										
Open Impeller											
Clearance	.06 (1.5) Total .015 (0.4) Suction Side										
Eye Area sq. in. (cm ²)	10.6 (68)	10.6 (68)	2.8 (18)	7.9 (51)	9.4 (61)	10.6 (68)	26.8 (173)	7.7 (50)	13.5 (87)	14.4 (93)	30.2 (195)
Maximum Dia. Solids	0.5 (13)	0.6 (15)	0.4 (10)	0.4 (10)	0.7 (18)	0.8 (20)	0.8 (20)	0.5 (13)	0.6 (15)	0.7 (18)	1.0 (25)
Number of Vanes	5	5	4	5	4	4	6	4	4	4	5
Pumps Weights lbs/kg											
Pump Only	258 (116)	268 (121)	244 (110)	259 (117)	268 (121)	278 (125)	318 (143)	338 (152)	359 (162)	374 (168)	401 (180)
Casing											
Type	Single Volute										
Wall Thickness	0.44 (11) Minimum										
Maximum Working Pressure	See Pressure vs. Temperature Limit Chart										
Test pressure	Class 150 Flanges-250PSIG, Class 300 Flanges-450PSIG										
Rotating Element											
Wk ² Dry lbs-ft ² (kg-m ²)	0.53 (.022)	0.52 (.022)	0.68 (.029)	0.79 (.033)	1.04 (.043)	1.04 (.043)	1.08 (.045)	1.50 (.063)	1.80 (.076)	2.14 (.09)	2.48 (.104)
Wk ² Wet lbs-ft ² (kg-m ²)	0.80 (.033)	0.78 (.033)	1.02 (.043)	1.19 (.05)	1.56 (.066)	1.56 (.066)	1.62 (.068)	2.25 (.095)	2.70 (.113)	3.21 (.135)	3.72 (.156)
Maximum Speed (oil lube)	3500	3500	3500	3500	3500	3500	1750	3500	3500	3500	1750
Power Limits											
HP (KW)/100 RPM 316SS	3.4 (2.6)										
HP (KW)/100 RPM 17-4Ph	4.2 (3.1)										
HP (KW)/100 RPM 17-4Ph High Torque	5.6 (4.2)										

Reference drawings A40210, A40211

Blackmer® Centrifugal Design Data | Frame A/LD17

Blackmer® Centrifugal Pumps Design Data FRAME A

Inches (mm)

	2.0 x 3.0-08	3.0 x 4.0-08	1.0 x 2.0-10	1.5 x 3.0-10	2.0 x 3.0-10	3.0 x 4.0-10	4.0 x 6.0-10	1.5 x 3.0-13	2.0 x 3.0-13	3.0 x 4.0-13	4.0 x 6.0-13
Shaft											
L3/D4 Ratio	52 (1.98)										
Diameter at Impeller	1.06 (27) 1.00-12 UNF Thread High Torque 1.31 (33) 1.25-12 UNF Thread										
Diameter at Seal	1.875 (48)										
Diameter Between Bearings	2.45 (62)										
Diameter at Coupling	1.375 (35)										
Bearings											
Thrust	SKF 7310 BEGAY (pair)										
Radial	6310 C3										
Bearing Span	6.02 (153)										
Shaft Overhang	8.63 (219)										
Seal Chamber											
Seal Bore Diameter (nose)	2.69 (68) nose										
Inside Bore	3.75 (95)										
Depth	2.88 (73)										
Back Cover/Shaft Clearance	.12 (3) Diametral										
Gland Bolting ANSI	4X .500-13UNC on 4.75 B.C. (12 on 121 B.C.)										
Distance to Nearest Obstruction	3.00 (76)										
Open Impeller											
Clearance	.06 (1.5) Total .015 (0.4) Suction Side										
Eye Area sq. in. (cm ²)	10.6 (68)	10.6 (68)	2.8 (18)	7.9 (51)	9.4 (61)	10.6 (68)	26.8 (173)	7.7 (50)	13.5 (87)	14.4 (93)	30.2 (195)
Maximum Dia. Solids	0.5 (13)	0.6 (15)	0.4 (10)	0.4 (10)	0.7 (18)	0.8 (20)	0.8 (20)	0.5 (13)	0.6 (15)	0.7 (18)	1.0 (25)
Number of Vanes	5	5	4	5	4	4	6	4	4	4	5
Pumps Weights/Lbs. (kg.)											
Pump Only	258 (116)	268 (121)	244 (110)	259 (117)	268 (121)	278 (125)	318 (143)	338 (152)	359 (162)	374 (168)	401 (180)
Casing											
Type	Single Volute										
Wall Thickness	0.44 (11) Minimum										
Maximum Working Pressure	See Pressure vs. Temperature Limit Chart										
Test pressure	Class 150 Flanges-250PSIG, Class 300 Flanges-450PSIG										
Rotating Element											
Wk ² Dry lbs-ft ² (kg-m ²)	0.53 (.022)	0.52 (.022)	0.68 (.029)	0.79 (.033)	1.04 (.043)	1.04 (.043)	1.08 (.045)	1.50 (.063)	1.80 (.076)	2.14 (.09)	2.48 (.104)
Wk ² Wet lbs-ft ² (kg-m ²)	0.80 (.033)	0.78 (.033)	1.02 (.043)	1.19 (.05)	1.56 (.066)	1.56 (.066)	1.62 (.068)	2.25 (.095)	2.70 (.113)	3.21 (.135)	3.72 (.156)
Maximum Speed (oil lube)	3500	3500	3500	3500	3500	3500	1750	3500	3500	3500	1750
Power Limits											
HP (KW)/100 RPM 316SS	3.4 (2.6)										
HP (KW)/100 RPM 17-4Ph	4.2 (3.1)										
HP (KW)/100 RPM 17-4Ph High Torque	5.6 (4.2)										

Reference drawings A40210, A40211

Blackmer® Centrifugal Assembly & Parts List | Frame A/LD17

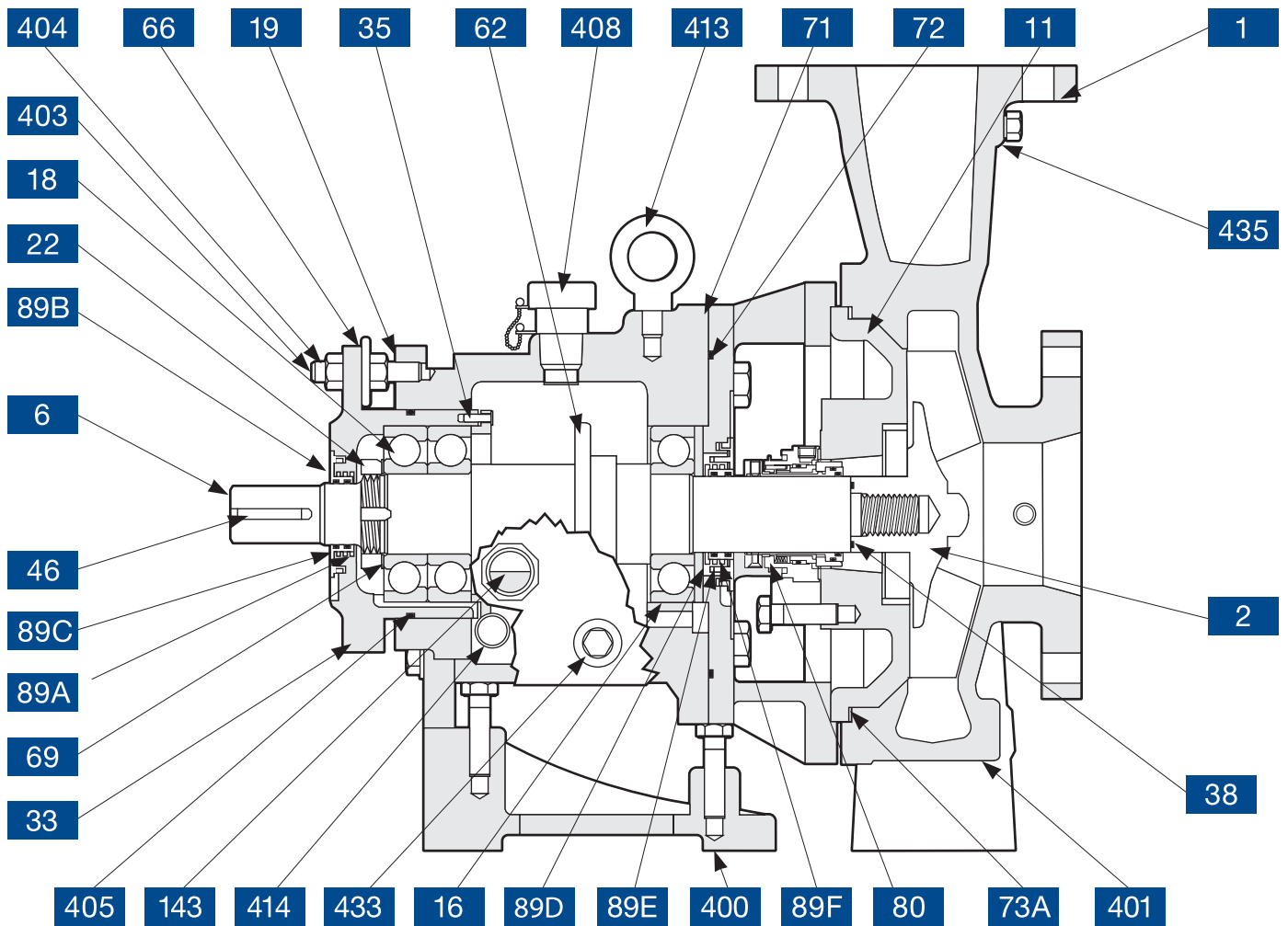

NO.	ITEM	NO.	ITEM	NO.	ITEM
1	Casing	62	Flinger	89F	Seal, Labyrinth O-Ring (Radial)
2	Impeller	66	Micrometer Nut	143	Oil Sight Glass
6	Shaft	69	Lockwasher, Thrust Bearing	400	Foot, Bearing Frame
11	Back Cover	71	Frame Adapter	401	Foot, casing
16	Bearing, Radial	72	O-Ring Frame Adapter	403	Stud, Cartridge
18	Bearing, Thrust	73A	Gasket, Casing	404	Locknut, Cartridge
19	Bearing, Frame	80	Mechanical Seal	405	O-Ring, Cartridge
22	Locknut, Thrust Bearing	89A	Seal, Labyrinth Stator, (Thrust) ¹	408	Oil Filler Assembly
33	Bearing Cartridge	89B	Seal, Labyrinth Rotor, (Thrust)	413	Bolt, Eye
35	Retainer Cover	89C	Seal, Labyrinth O-Ring, (Thrust)	414	Pipe Plug, Magnetic
38	O-ring, Impeller Hub	89D	Seal, Labyrinth Stator, (Radial)	433	Pipe Plug, Bearing Frame
46	Key, Coupling	89E	Seal, Labyrinth Rotor, (Radial)	435	Pipe Plug, Casing

¹Incorporated as part of cartridge in 2000.

Blackmer® Centrifugal Auxiliary Pipe Connections List | Frame A/LD17

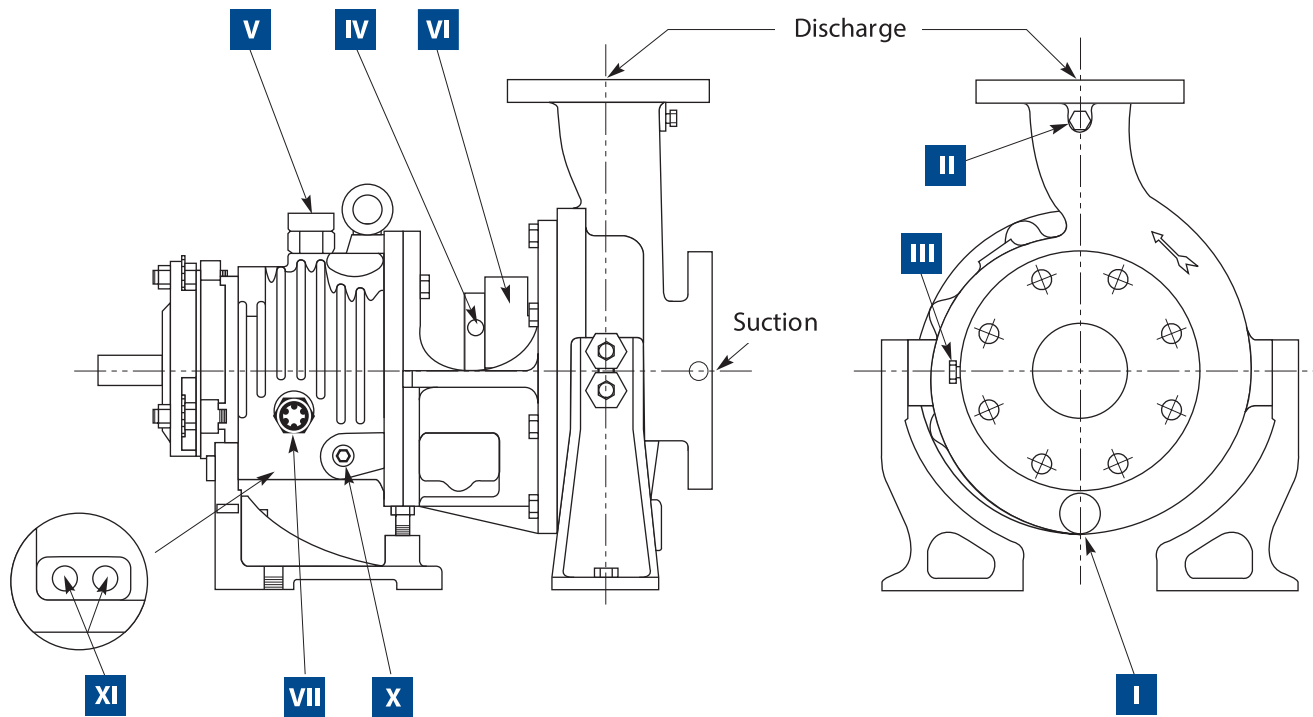

ITEM NUMBER	NPT SIZE	NUMBER OF TAPS	CONNECTION
* I	0.50-14	1	Casing Drain
II	0.25-18	1	Discharge Gage
# III	0.25-14	1	Suction Gage
* IV	0.25-18	1	Seal Chamber Flush (not available on LD17)
V	0.75-14	1	Oil Fill
VI	0.25-18	2	Seal Chamber Jacket* - Inlet & Outlet (not available on LD17)
# VII	1.00-11.5	1	Oil Sight Glass
# X	0.25-18	1	Oil Drain
## XI	0.50-14	2	Magnetic Plug or Cooling Coil*

* Optional

Left side of pump facing suction end

Right side of pump facing suction end

(4x6-10 & 4x6-13 Casings have discharge tap only)

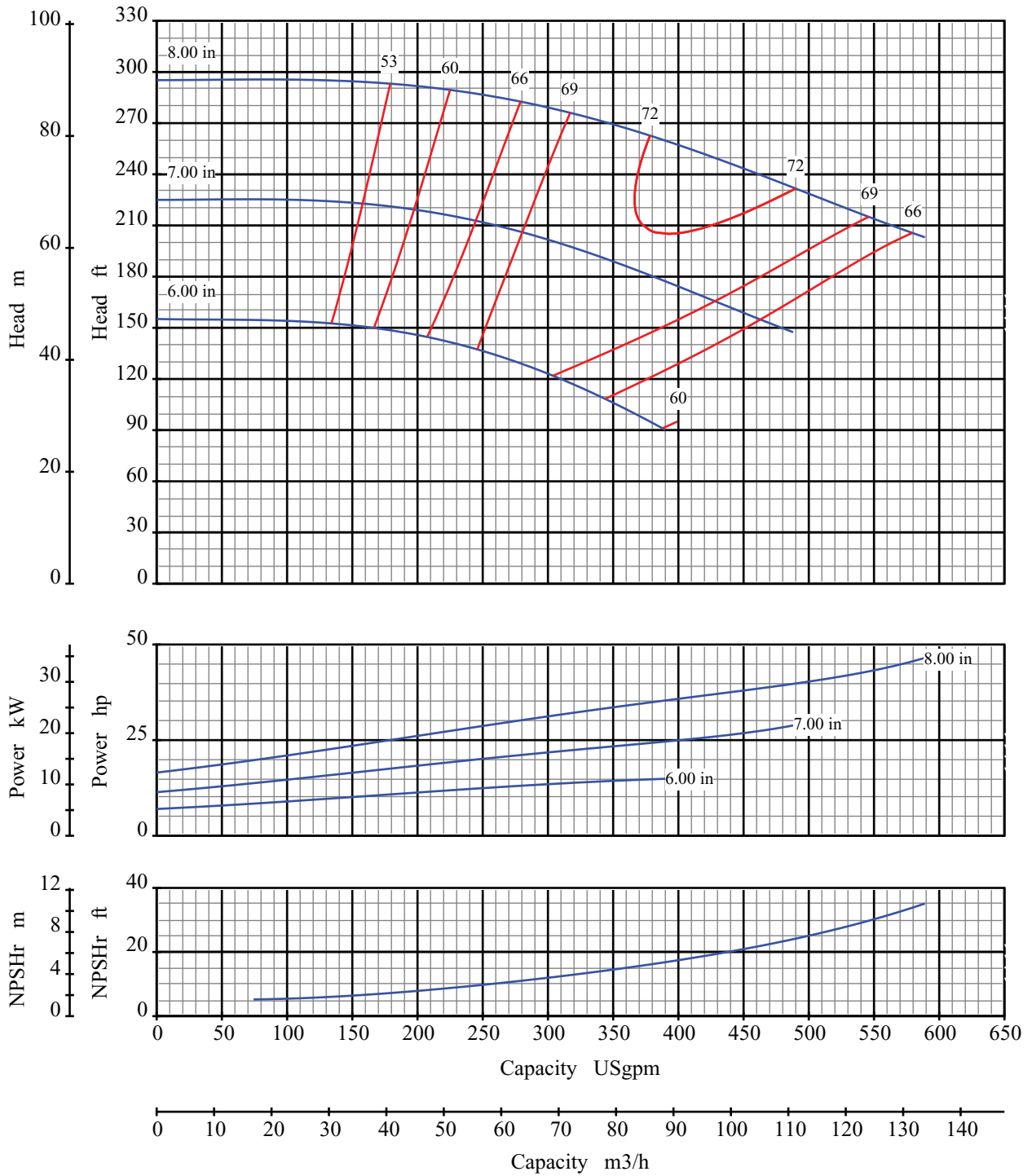

Curve No: S18142V1

Blackmer Centrifugal

Pump Performance Characteristics

Effective Date: Jan/2005

Catalog: 1301

Pump Size: 2x3 8

Pump Size: 50x80 200

Speed: 3550 rpm

Open Impeller

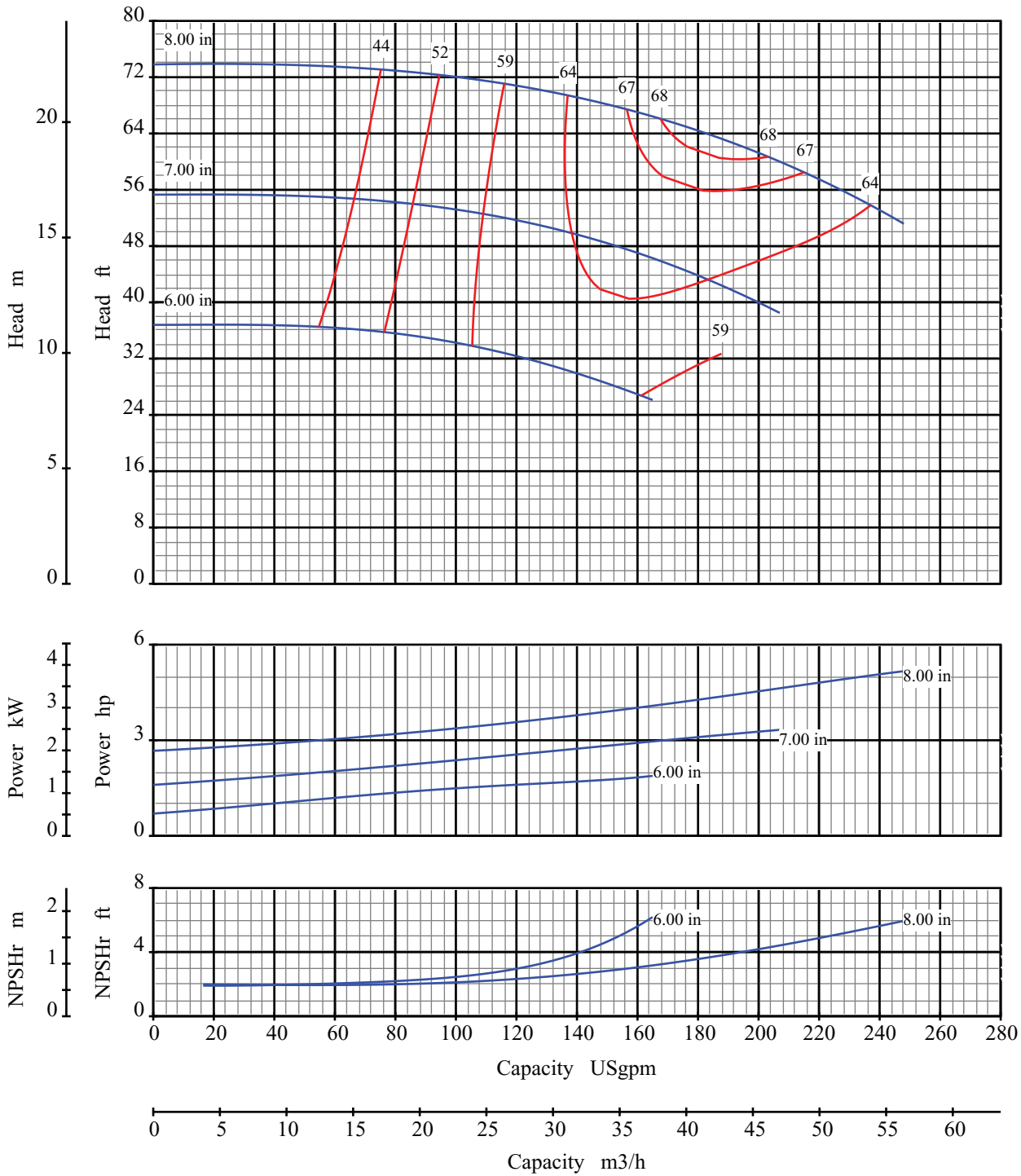

Curve No: S18144V1

Effective Date: Jan/2005

Blackmer Centrifugal

Pump Performance Characteristics

Catalog: 1301

Pump Size: 2x3 8

Pump Size: 50x80 200

Speed: 1750 rpm

Open Impeller

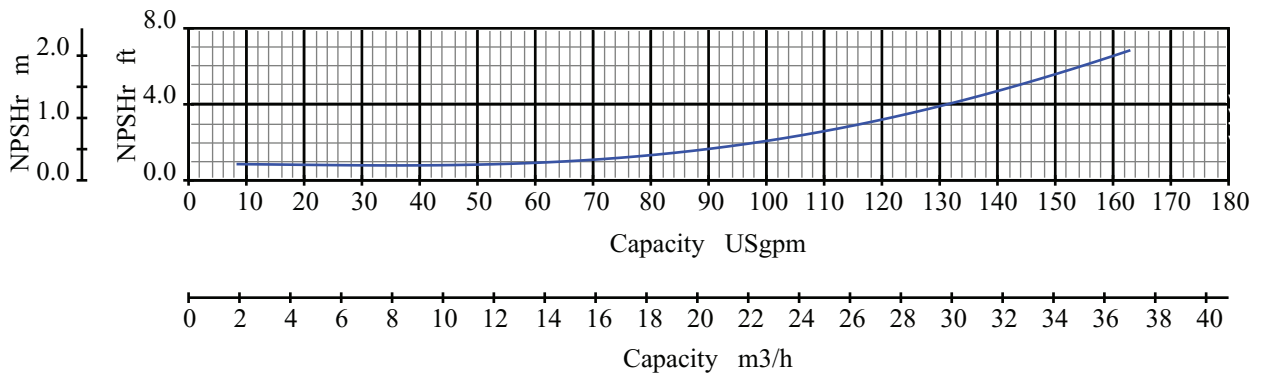
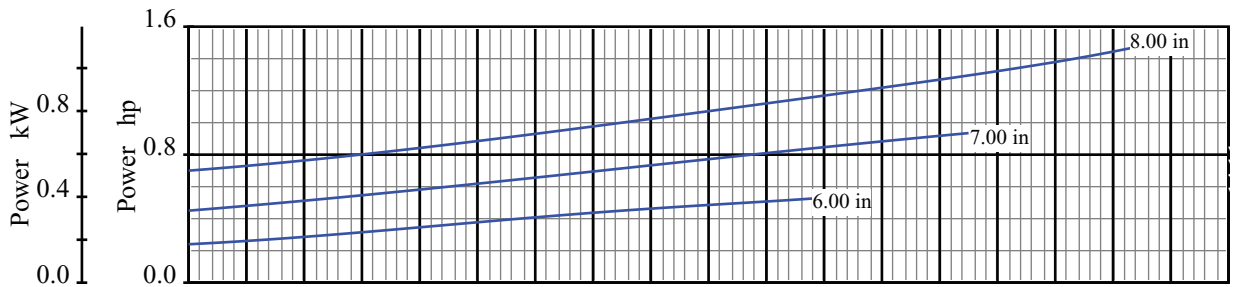
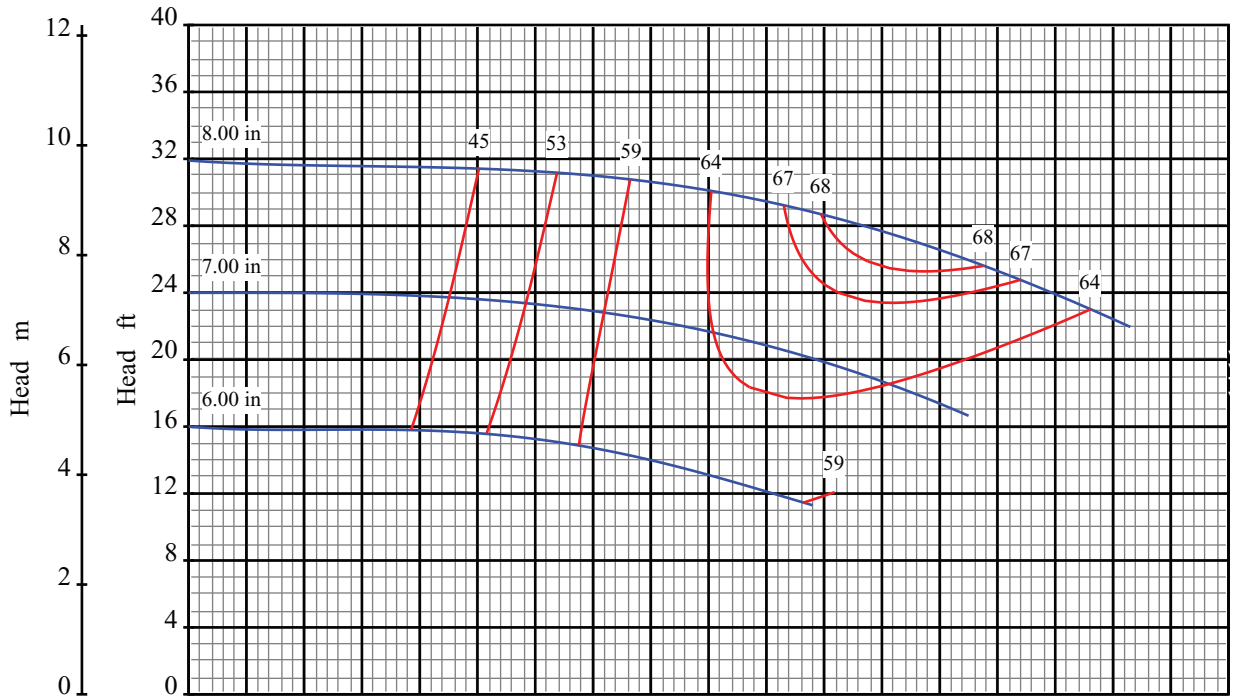

Curve No: S18146V1

Effective Date: Jan/2005

Blackmer Centrifugal

Pump Performance Characteristics

Catalog: 1301

Pump Size: 2x3 8

Pump Size: 50x80 200

Speed: 1150 rpm

Open Impeller

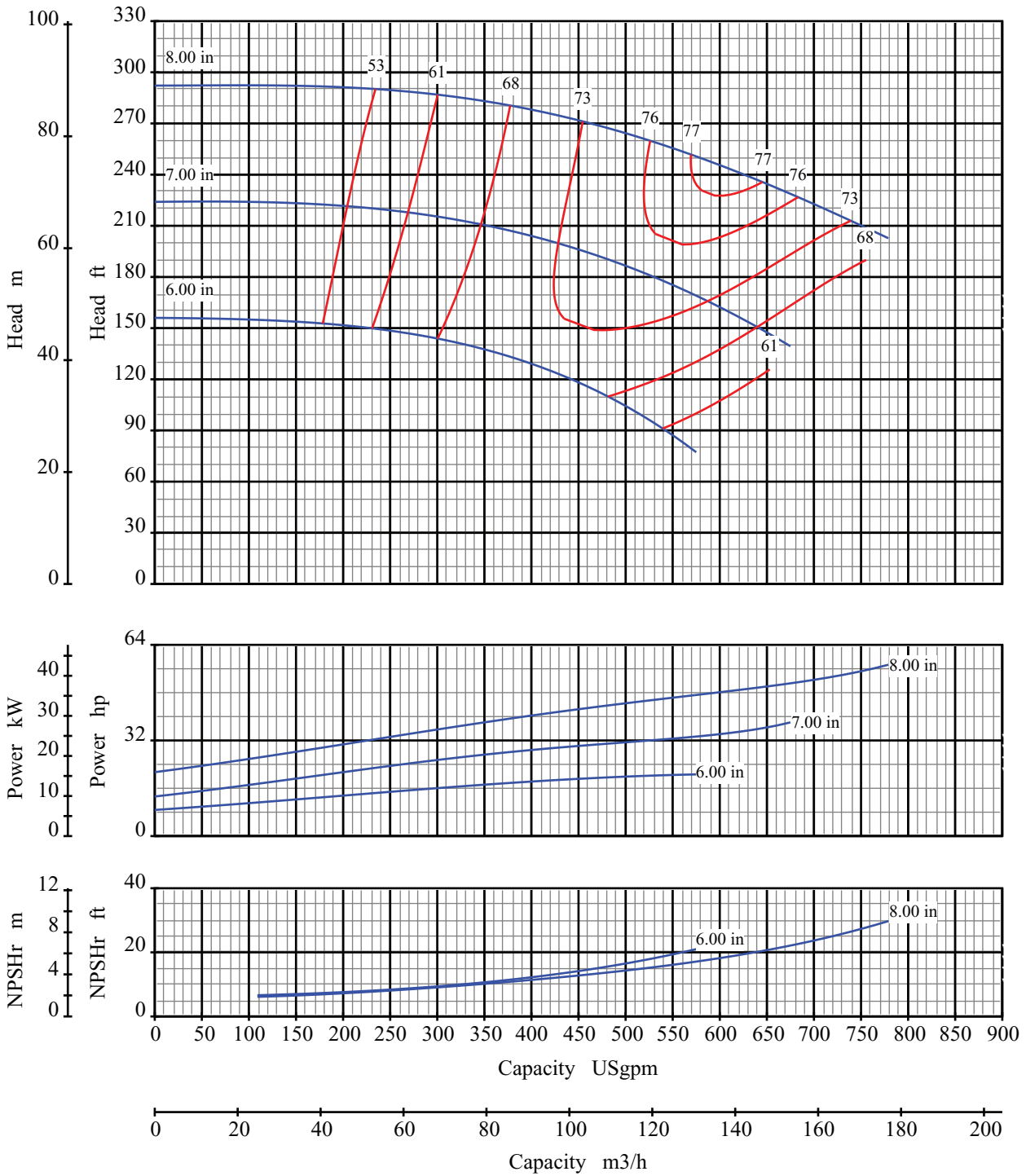

Curve No: S18148V1

Blackmer Centrifugal

Pump Performance Characteristics

Effective Date: Jan/2005

Catalog: 1301

Pump Size: 3x4 8

Pump Size: 80x100 200

Speed: 3550 rpm

Open Impeller

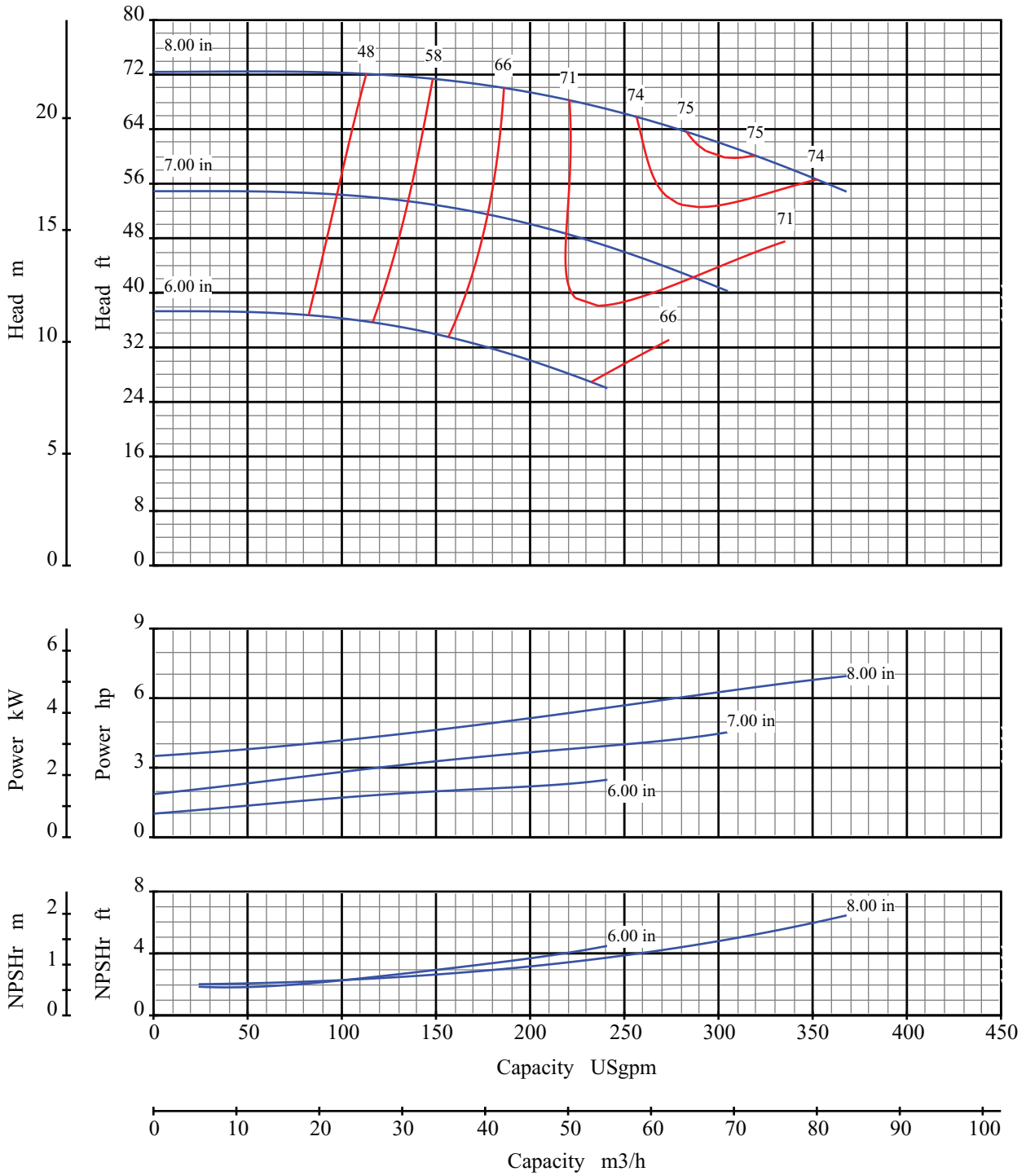

Curve No: S18150V1

Effective Date: Jan/2005

Blackmer Centrifugal

Pump Performance Characteristics

Catalog: 1301

Pump Size: 3x4 8

Pump Size: 80x100 200

Speed: 1750 rpm

Open Impeller

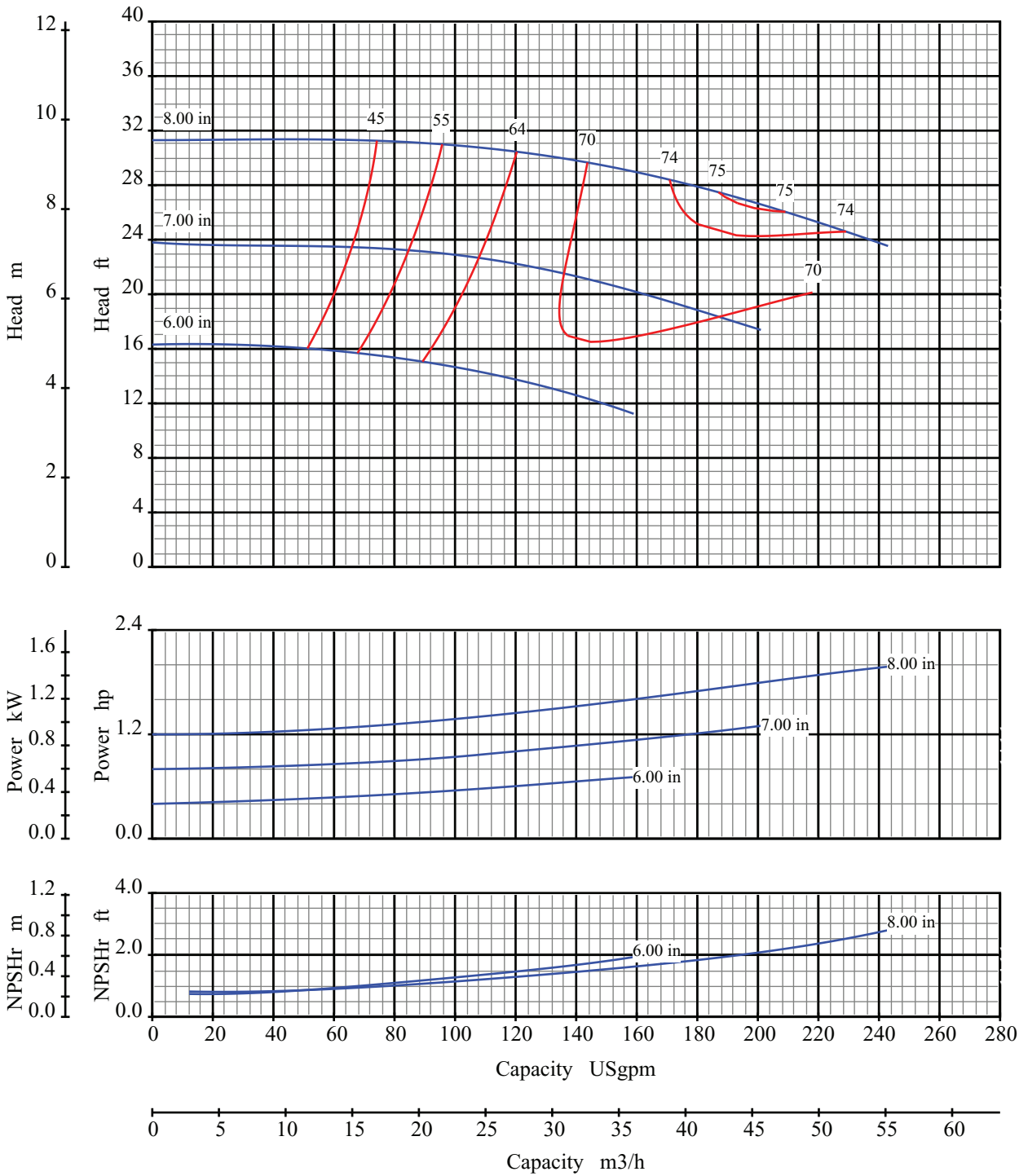

Curve No: S18152V1

Blackmer Centrifugal

Pump Performance Characteristics

Effective Date: Jan/2005

Catalog: 1301

Pump Size: 3x4 8

Pump Size: 80x100 200

Speed: 1150 rpm

Open Impeller

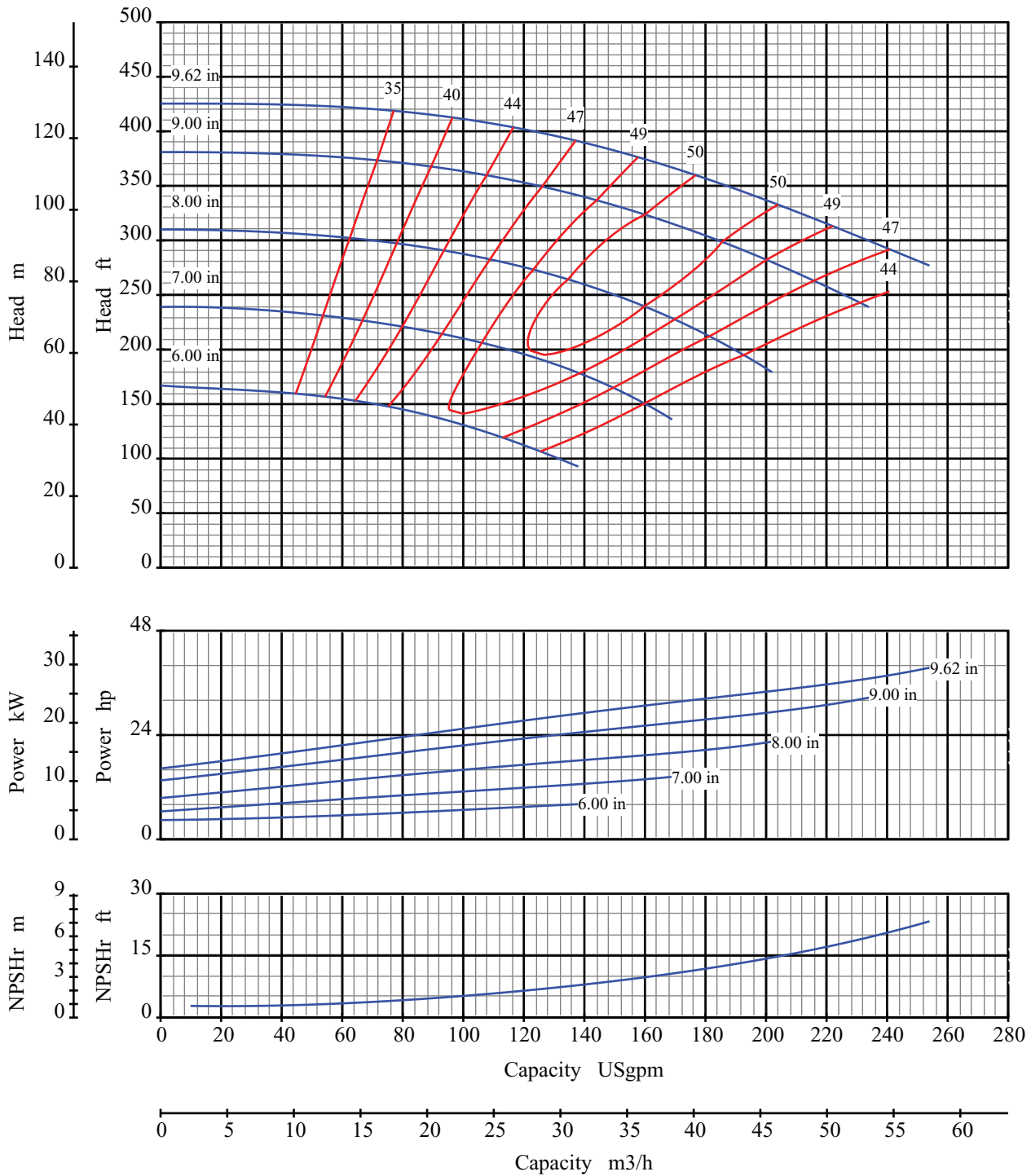

Curve No: S18154V1

Effective Date: Jan/2005

Blackmer Centrifugal

Pump Performance Characteristics

Catalog: 1301

Pump Size: 1x2 10

Pump Size: 25x50 250

Speed: 3550 rpm

Open Impeller

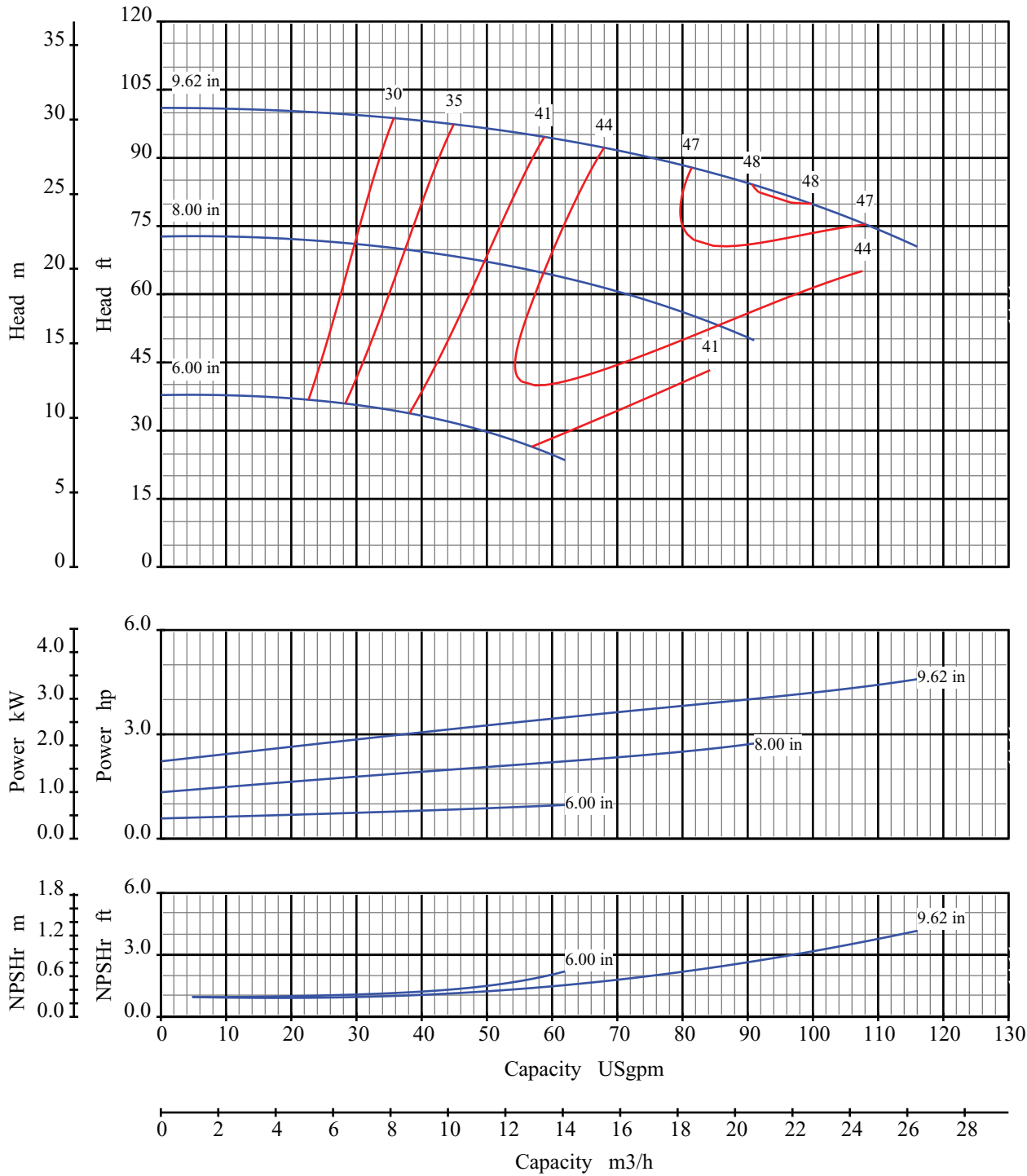

Curve No: S18156V1

Blackmer Centrifugal

Pump Performance Characteristics

Effective Date: Jan/2005

Catalog: 1301

Pump Size: 1x2 10

Pump Size: 25x50 250

Speed: 1750 rpm

Open Impeller

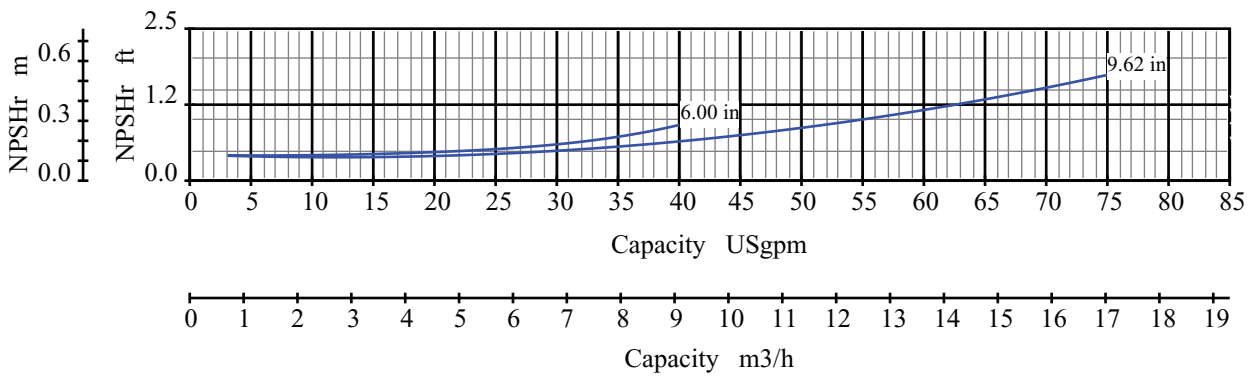
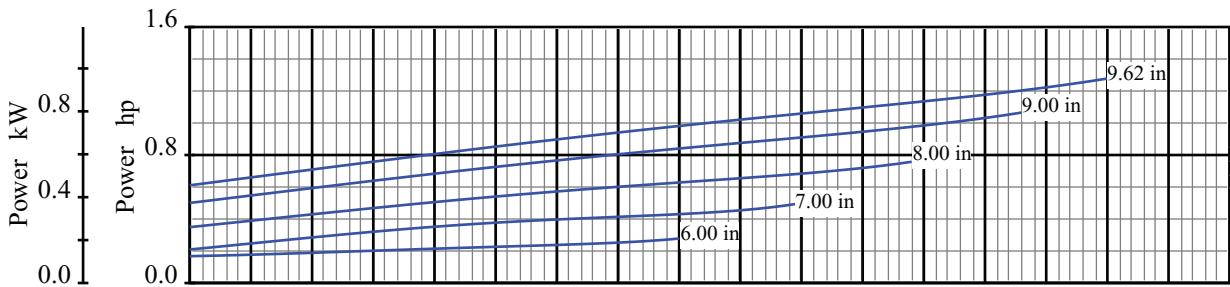
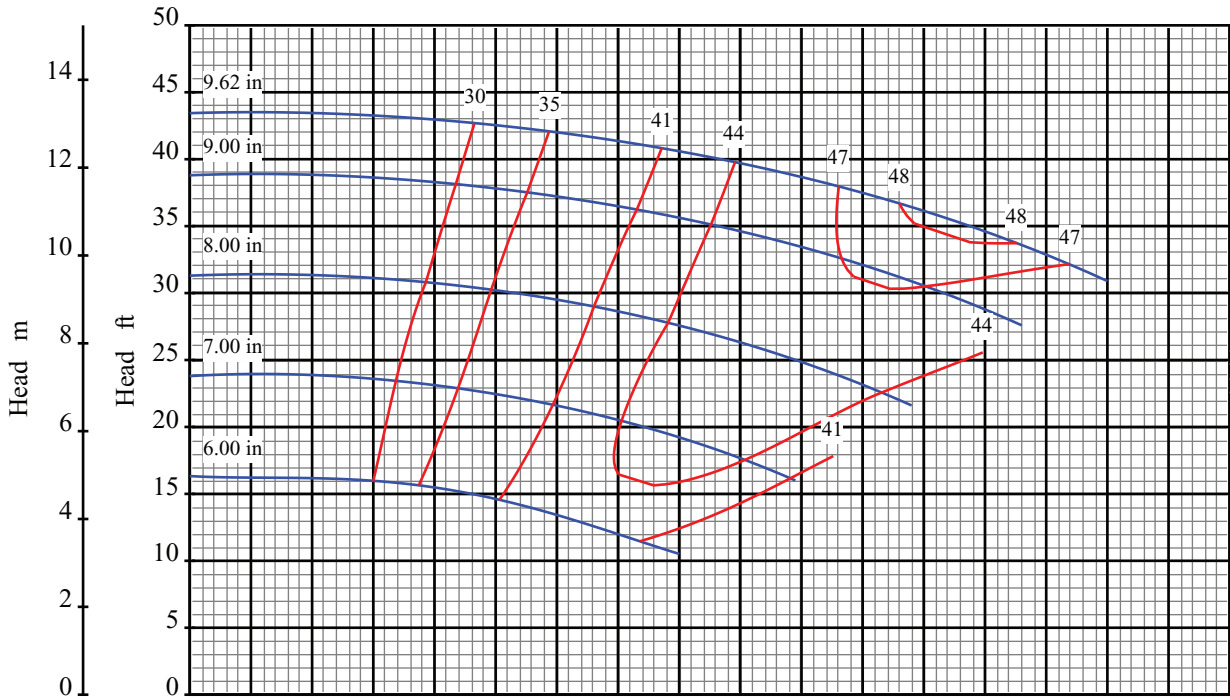

Curve No: S18158V1

Effective Date: Jan/2005

Blackmer Centrifugal

Pump Performance Characteristics

Catalog: 1301

Pump Size: 1x2 10

Pump Size: 25x50 250

Speed: 1150 rpm

Open Impeller

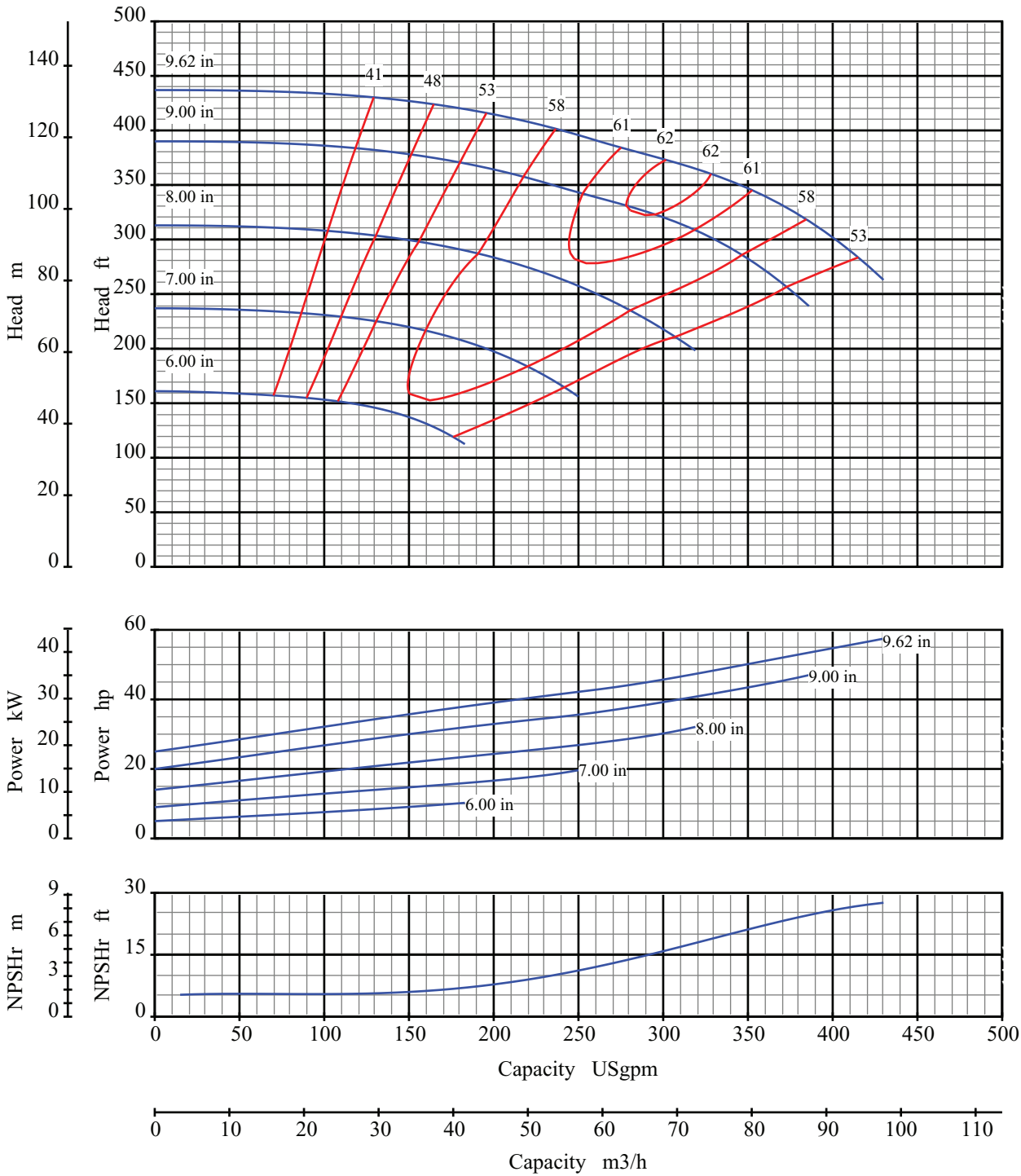

Curve No: S18160V1

Blackmer Centrifugal

Pump Performance Characteristics

Effective Date: Jan/2005

Catalog: 1301

Pump Size: 1.5x3 10

Pump Size: 40x80 250

Speed: 3550 rpm

Open Impeller

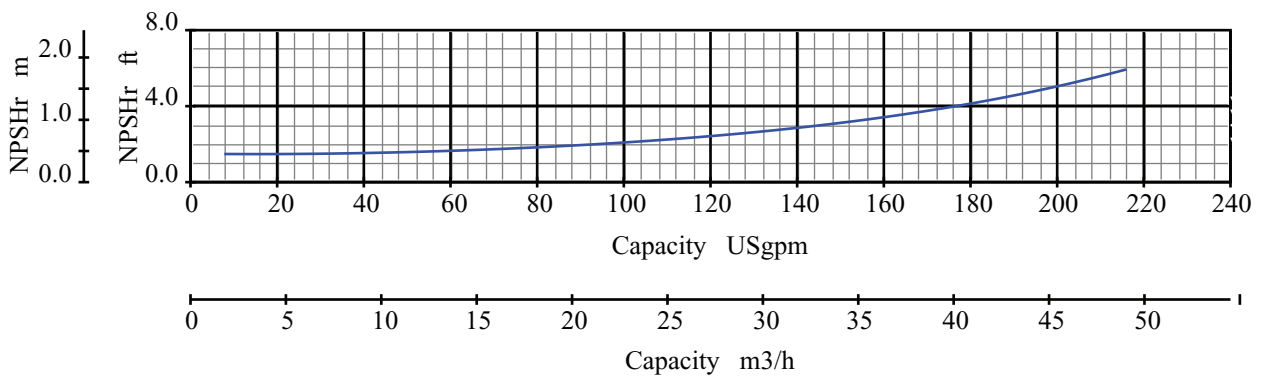
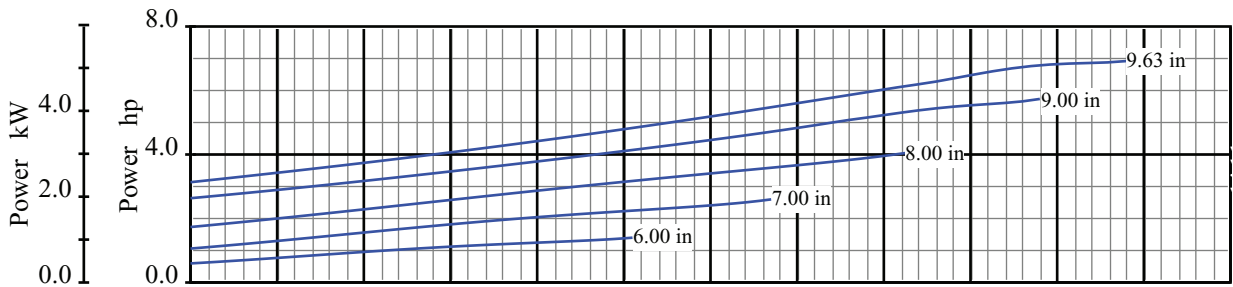
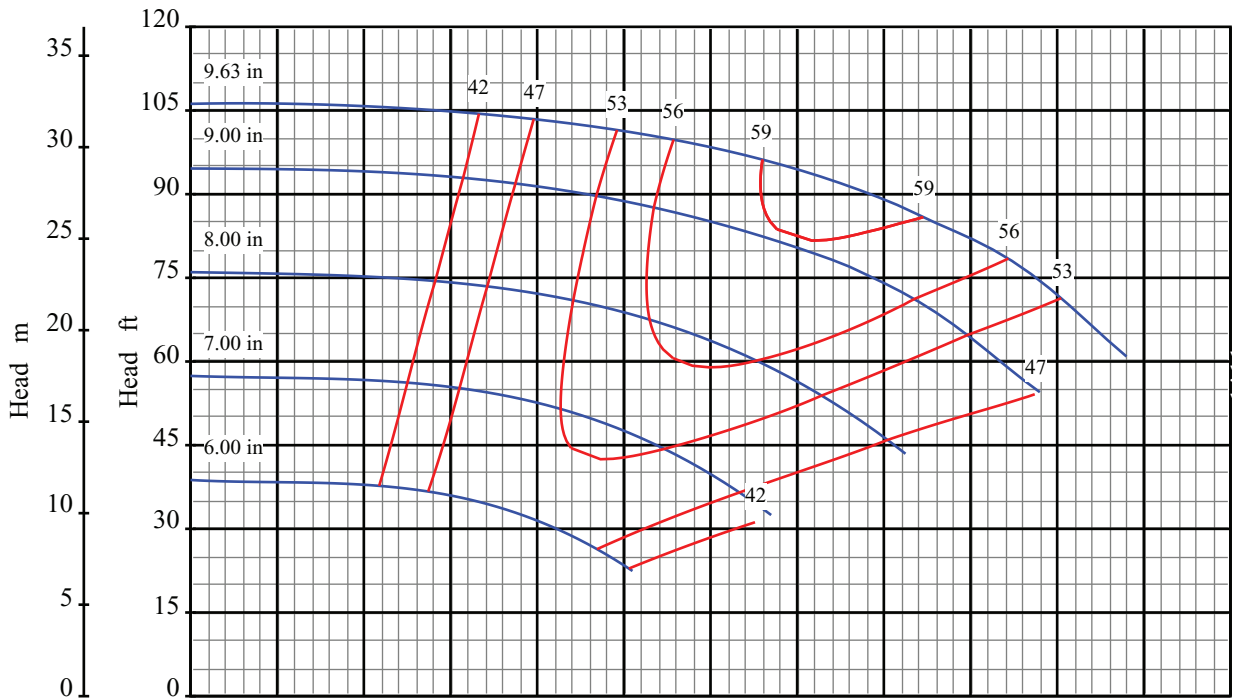

Curve No: S18162V1

Effective Date: Jan/2005

Blackmer Centrifugal

Pump Performance Characteristics

Catalog: 1301

Pump Size: 1.5x3 10

Pump Size: 40x80 250

Speed: 1750 rpm

Open Impeller

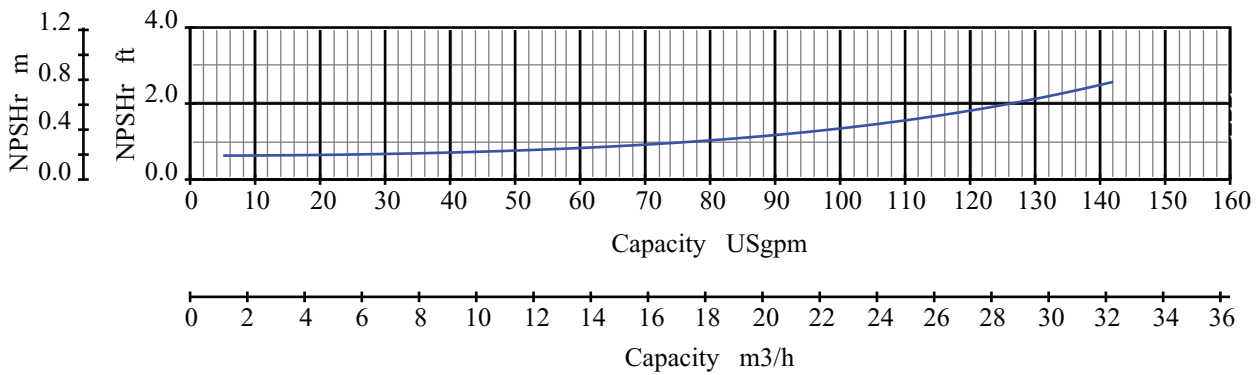
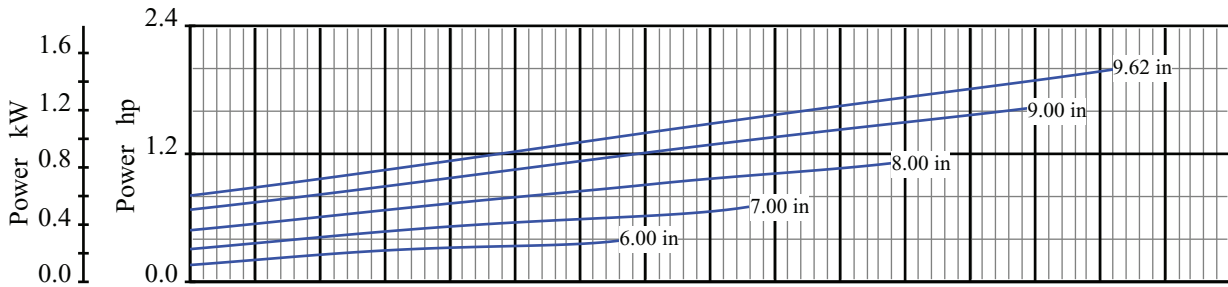
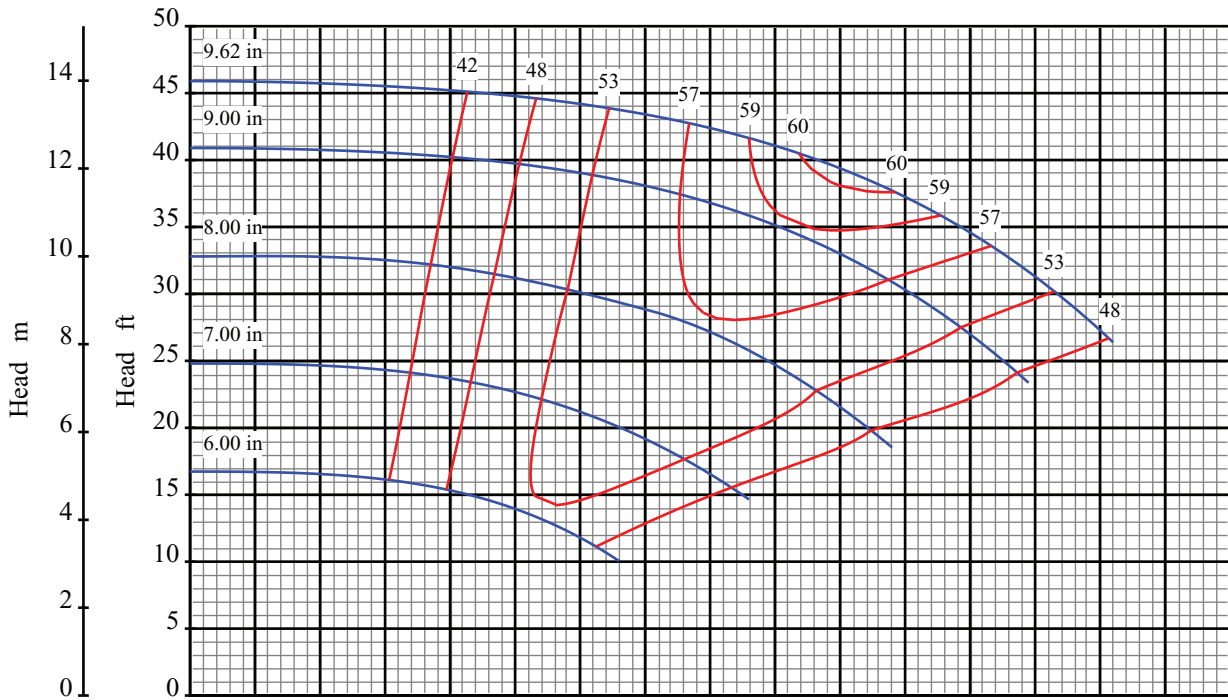

Curve No: S18164V1

Blackmer Centrifugal

Pump Performance Characteristics

Catalog: 1301

Effective Date: Jan/2005

Pump Size: 1.5x3 10

Pump Size: 40x80 250

Speed: 1150 rpm

Open Impeller

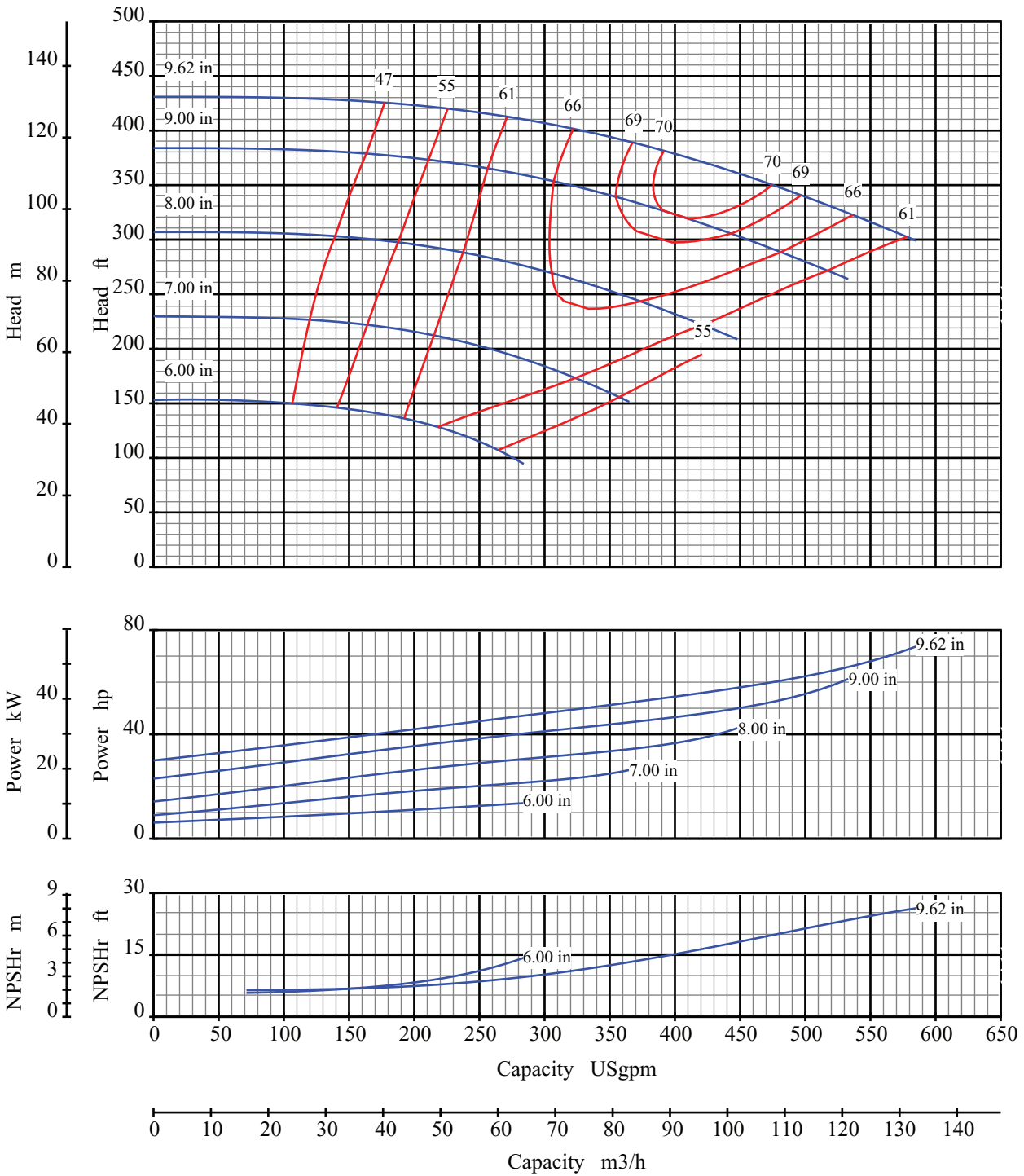

Curve No: S18166V1

Effective Date: Jan/2005

Blackmer Centrifugal

Pump Performance Characteristics

Catalog: 1301

Pump Size: 2x3 10

Pump Size: 50x80 250

Speed: 3550 rpm

Open Impeller

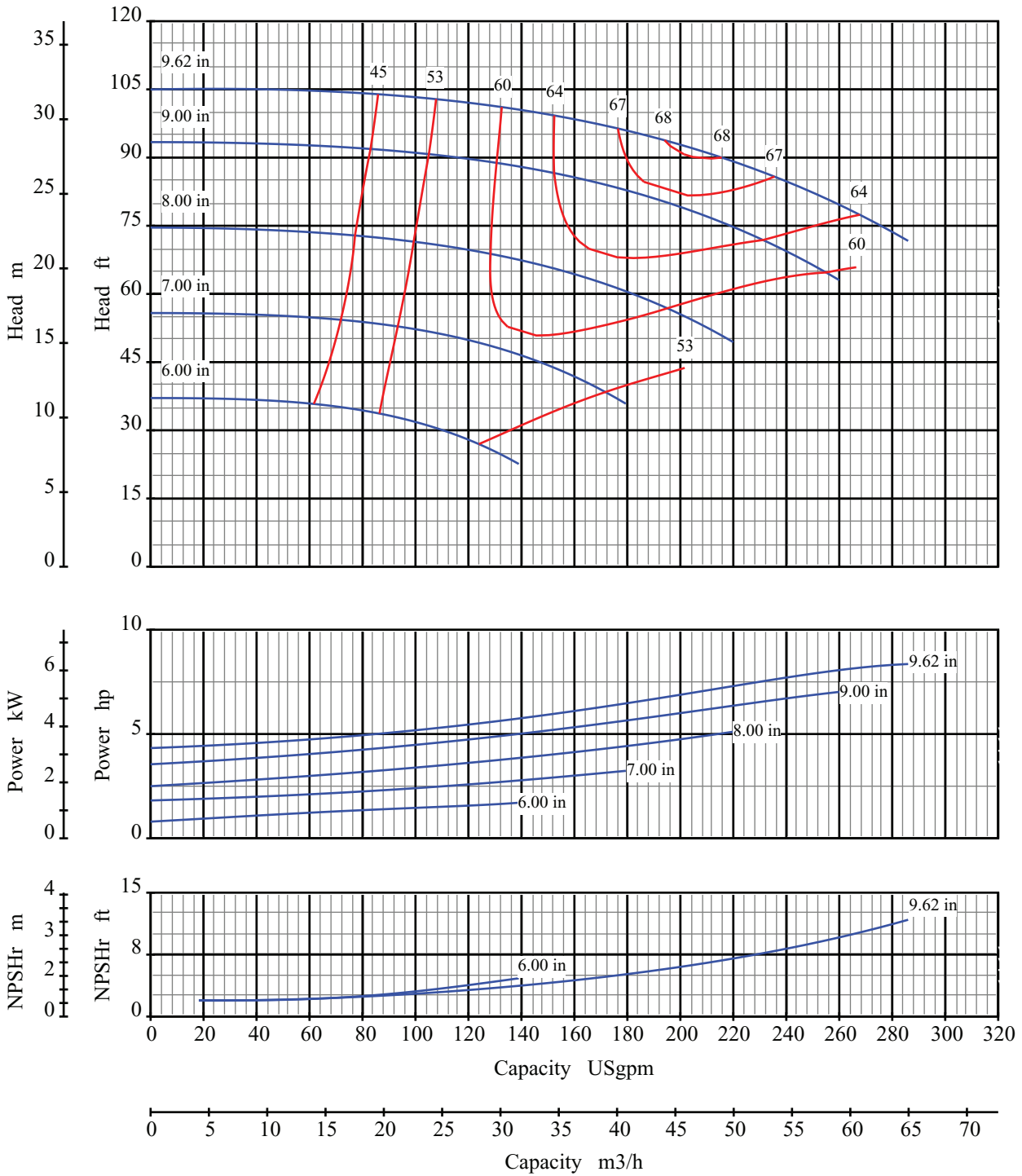

Curve No: S18168V1

Blackmer Centrifugal

Pump Performance Characteristics

Effective Date: Jan/2005

Catalog: 1301

Pump Size: 2x3 10

Pump Size: 50x80 250

Speed: 1750 rpm

Open Impeller

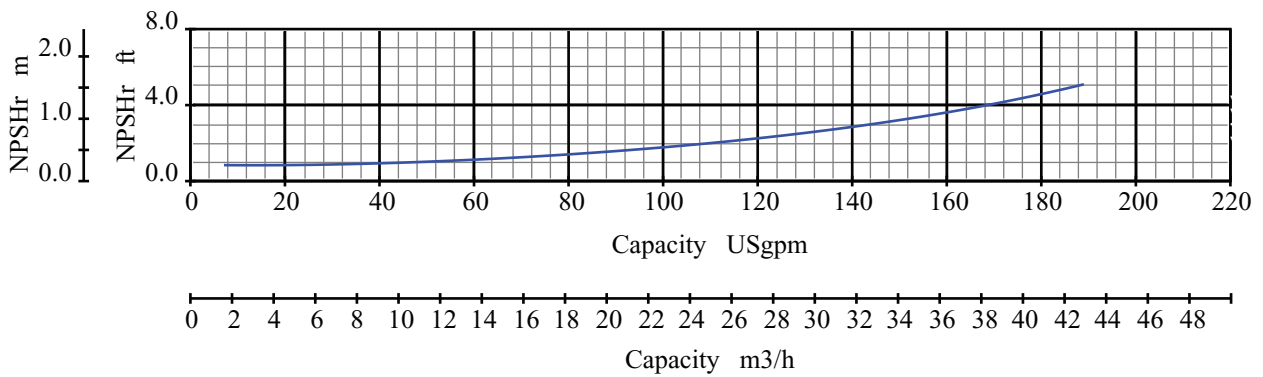
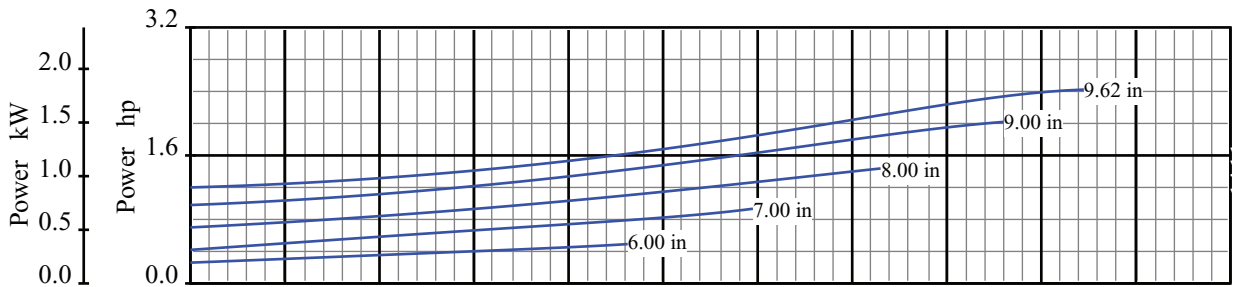
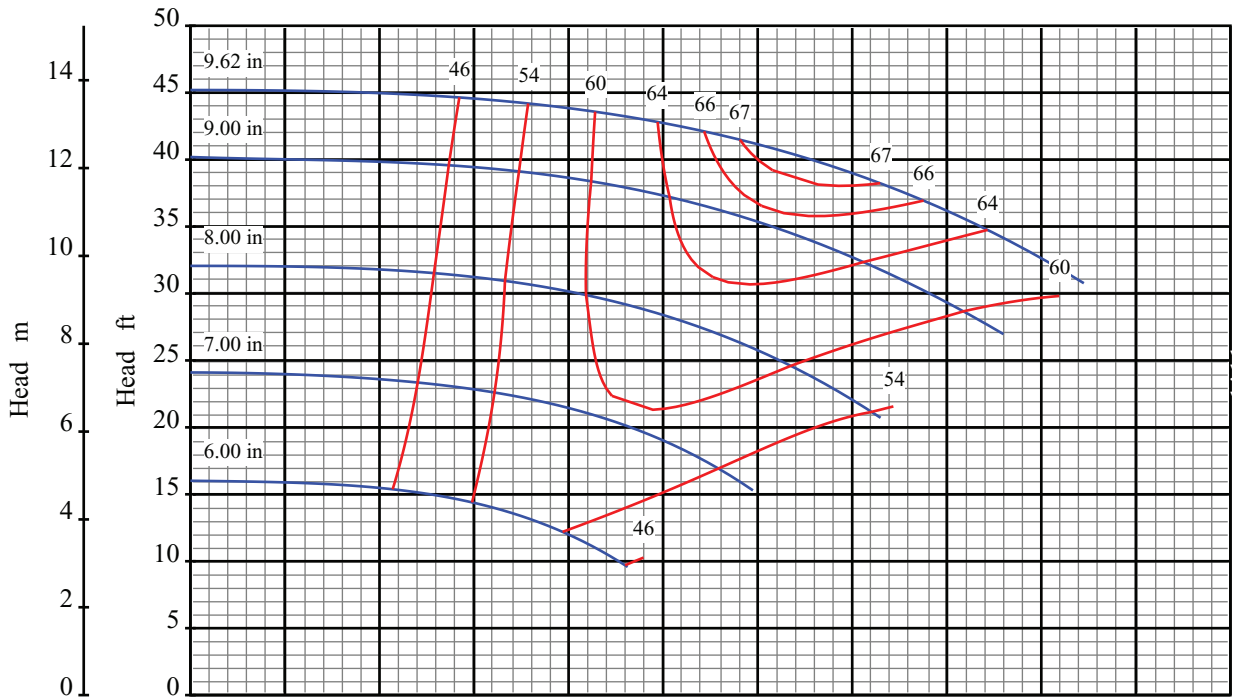

Curve No: S18170V1

Blackmer Centrifugal

Pump Size: 2x3 10

Pump Performance Characteristics

Pump Size: 50x80 250

Effective Date: Jan/2005

Catalog: 1301

Speed: 1150 rpm

Open Impeller

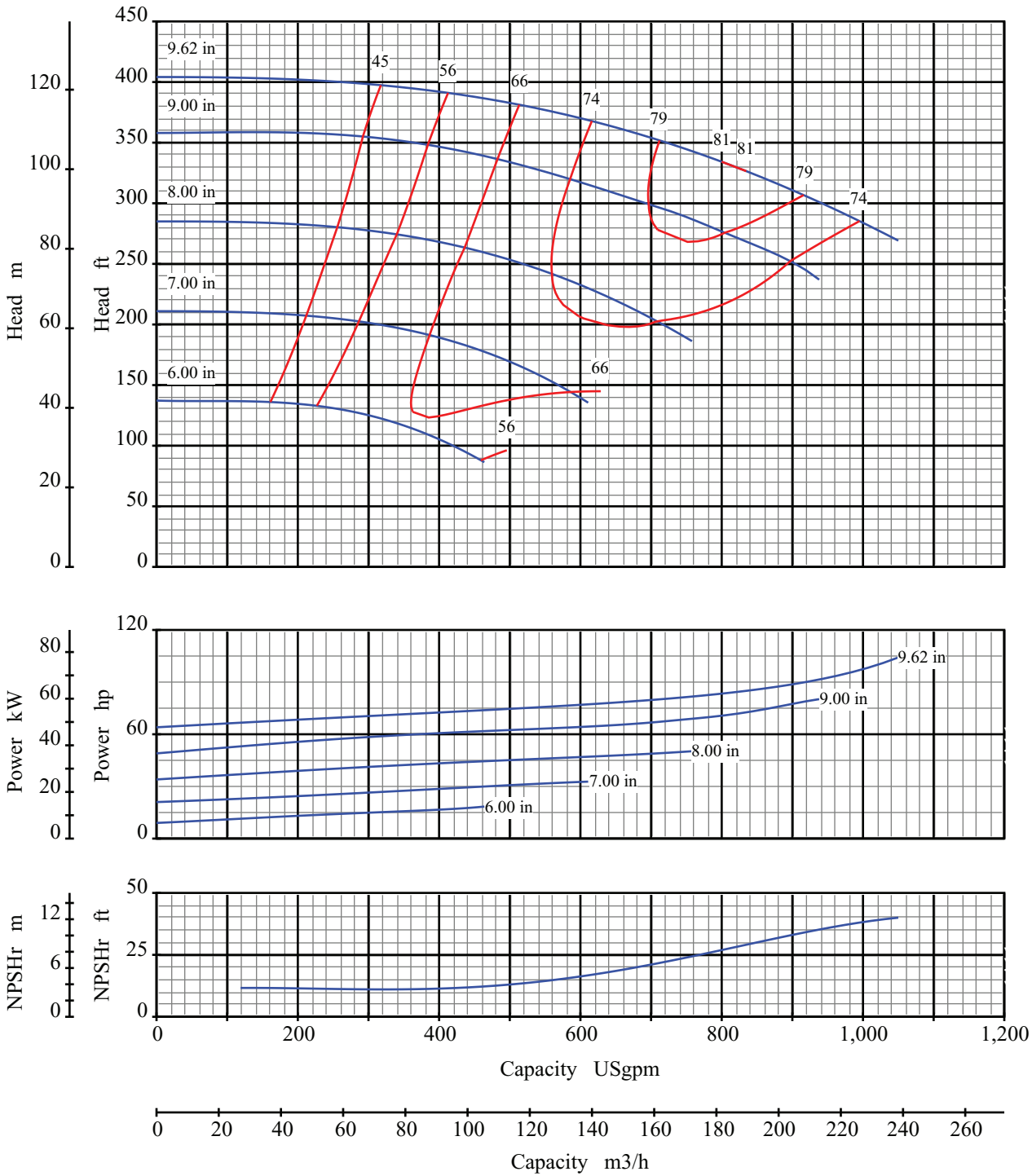

Curve No: S18172V1

Blackmer Centrifugal

Pump Performance Characteristics

Effective Date: Jan/2005

Catalog: 1301

Pump Size: 3x4 10

Pump Size: 80x100 250

Speed: 3550 rpm

Open Impeller

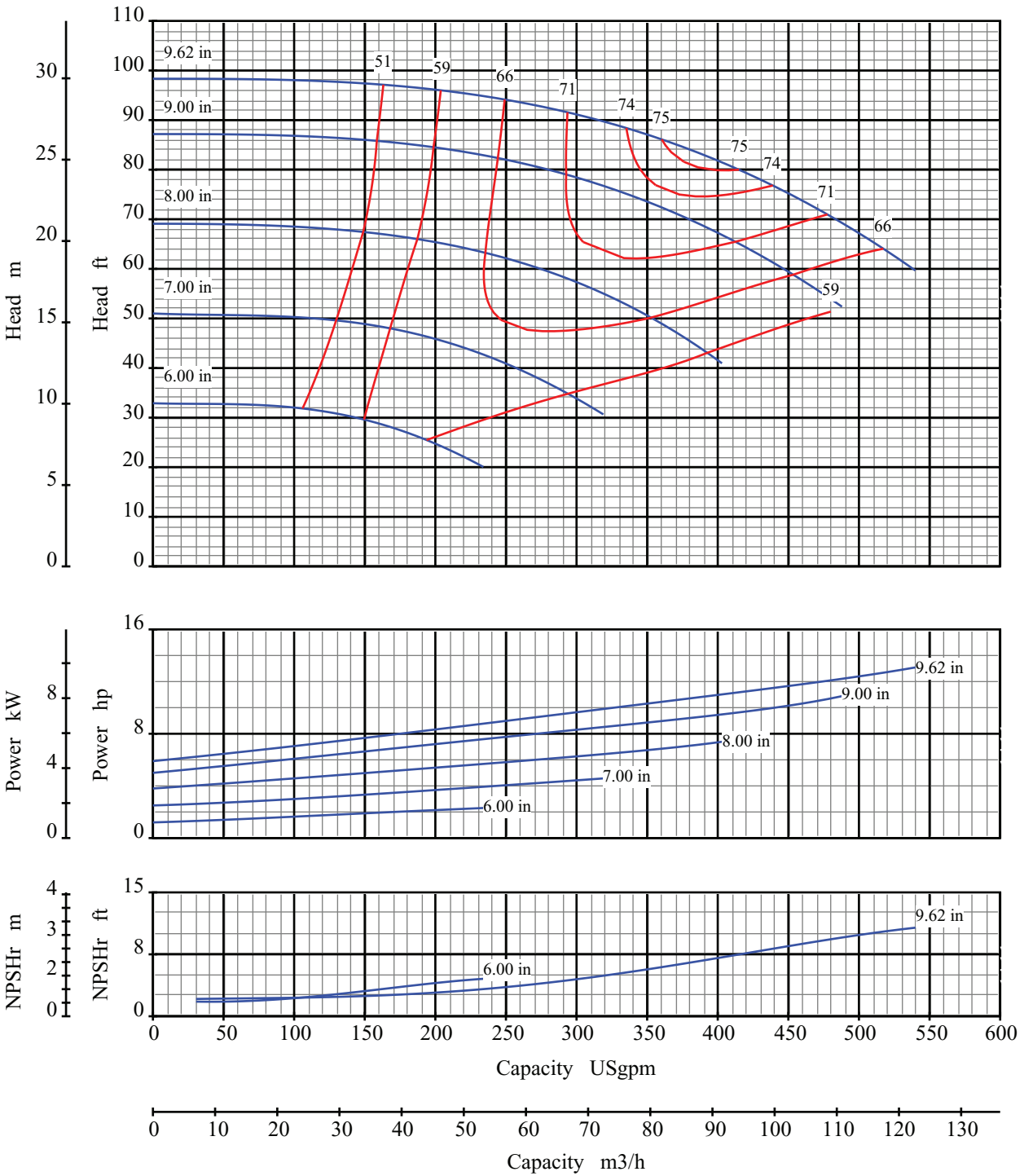

Curve No: S18174V1

Effective Date: Jan/2005

Blackmer Centrifugal

Pump Performance Characteristics

Catalog: 1301

Pump Size: 3x4 10

Pump Size: 80x100 250

Speed: 1750 rpm

Open Impeller

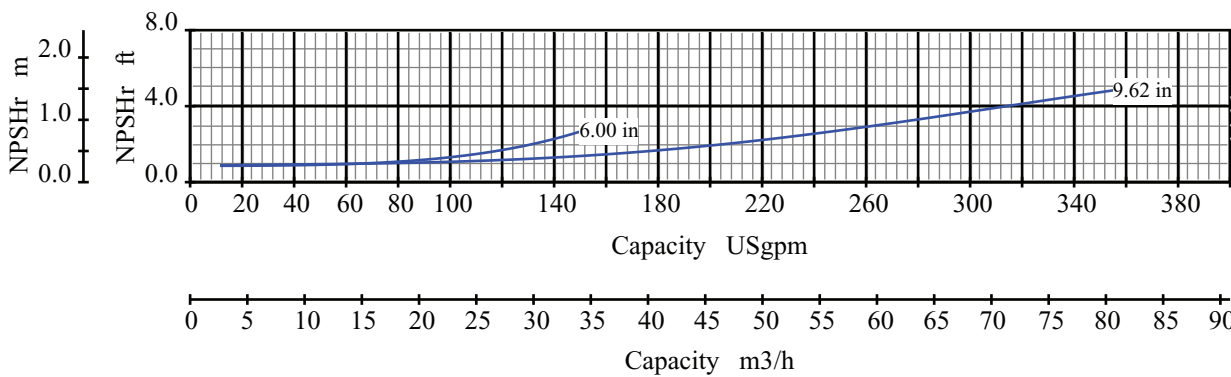
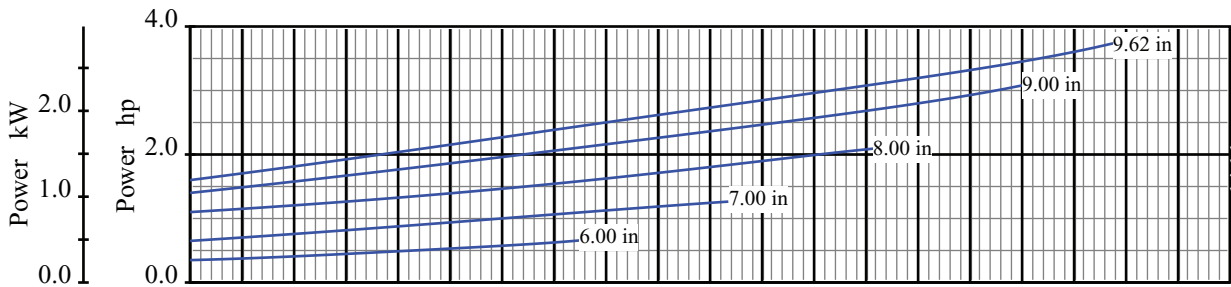
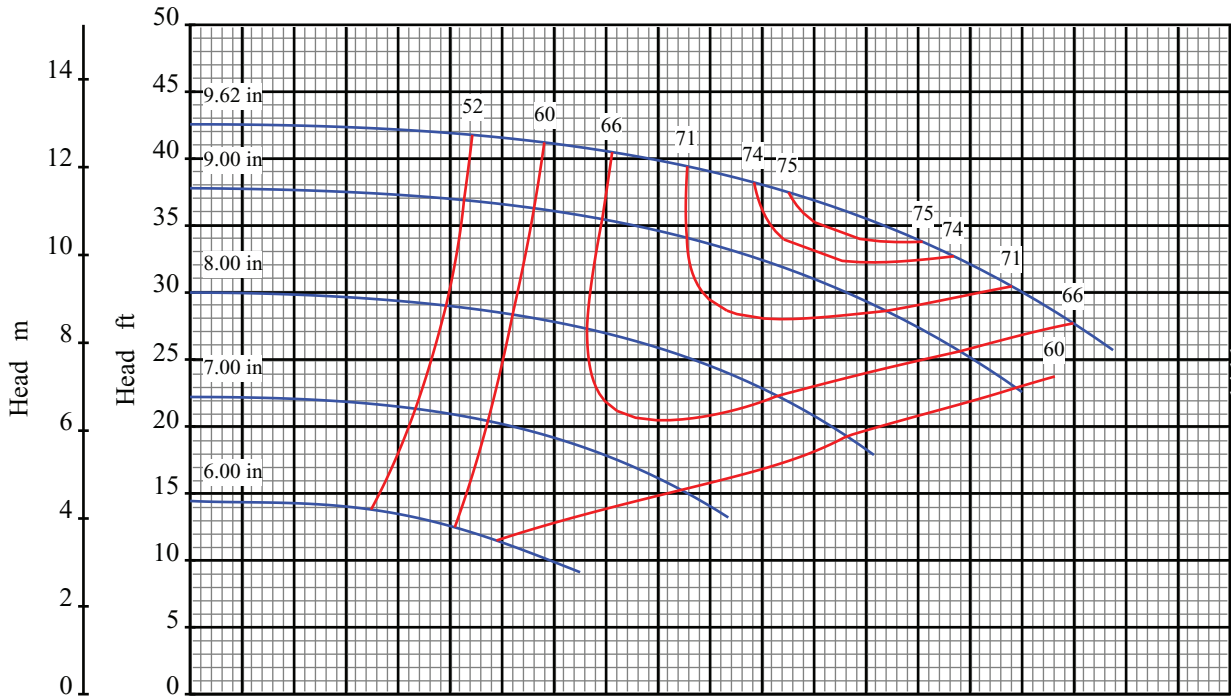

Curve No: S18176V1

Blackmer Centrifugal

Pump Performance Characteristics

Effective Date: Jan/2005

Catalog: 1301

Pump Size: 3x4 10

Pump Size: 80x100 250

Speed: 1150 rpm

Open Impeller

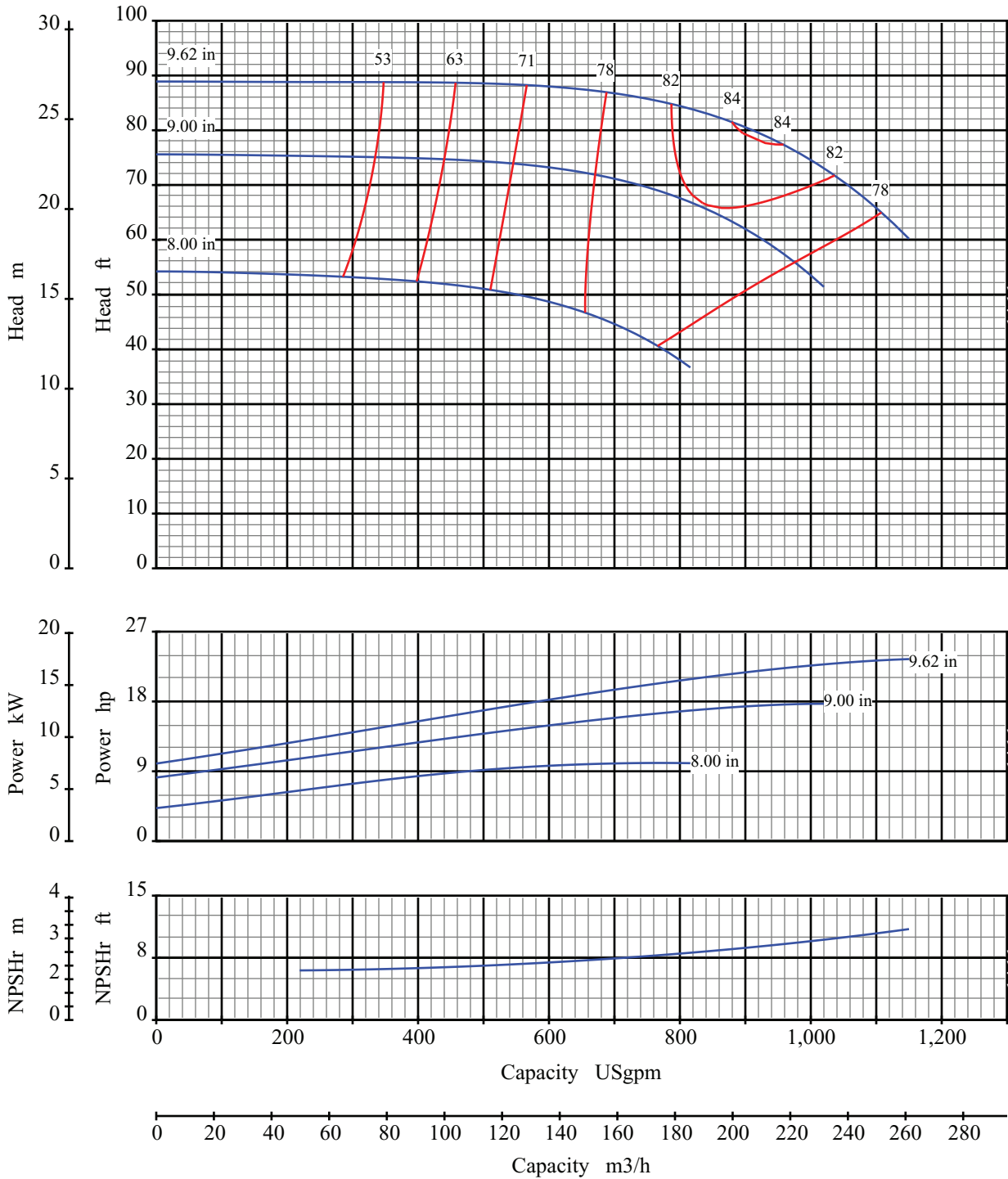

Curve No: S18180V1

Blackmer Centrifugal

Pump Size: 4x6 10

Pump Performance Characteristics

Pump Size: 100x150 250

Effective Date: Jan/2005

Catalog: 1301

Speed: 1750 rpm

Open Impeller

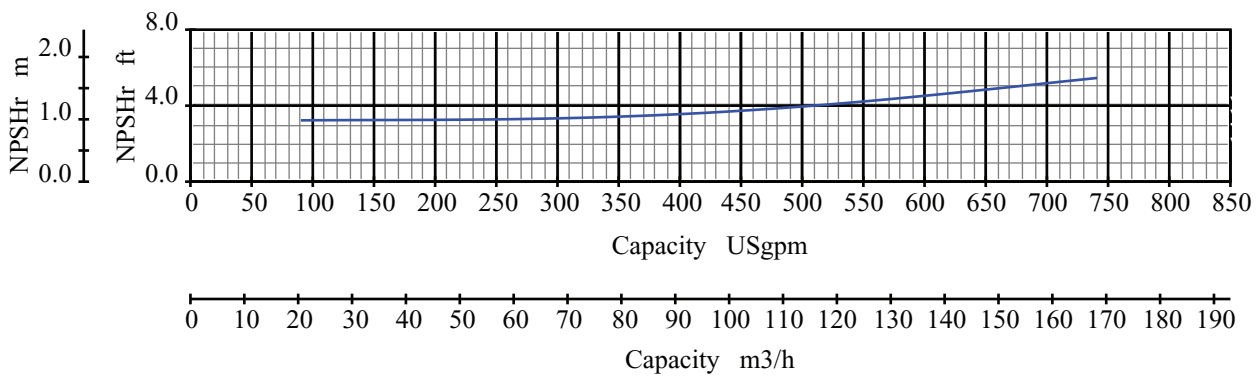
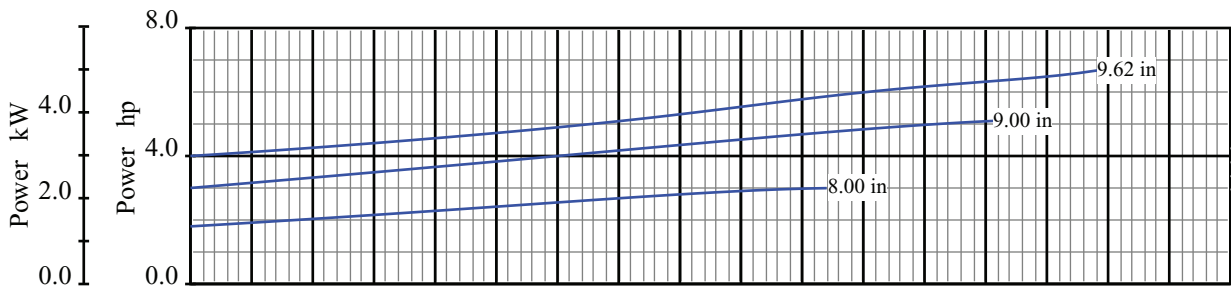
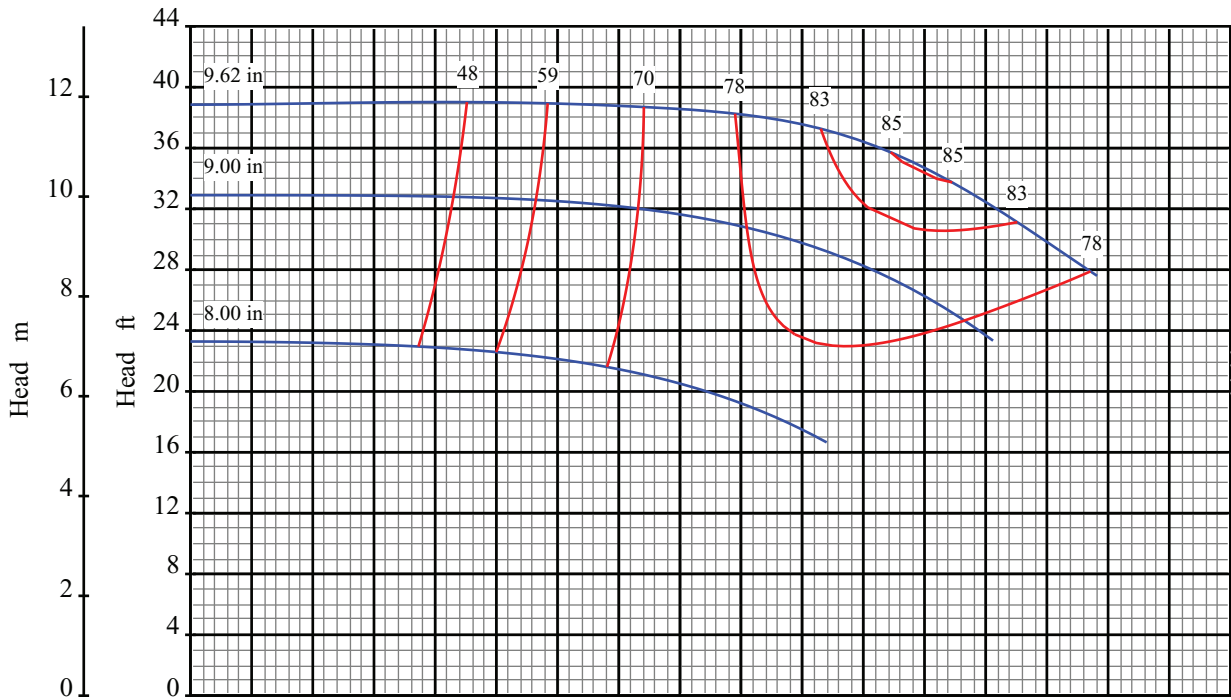

Curve No: S18182V1

Blackmer Centrifugal

Pump Size: 4x6 10

Pump Performance Characteristics

Pump Size: 100x150 250

Effective Date: Jan/2005

Catalog: 1301

Speed: 1150 rpm

Open Impeller

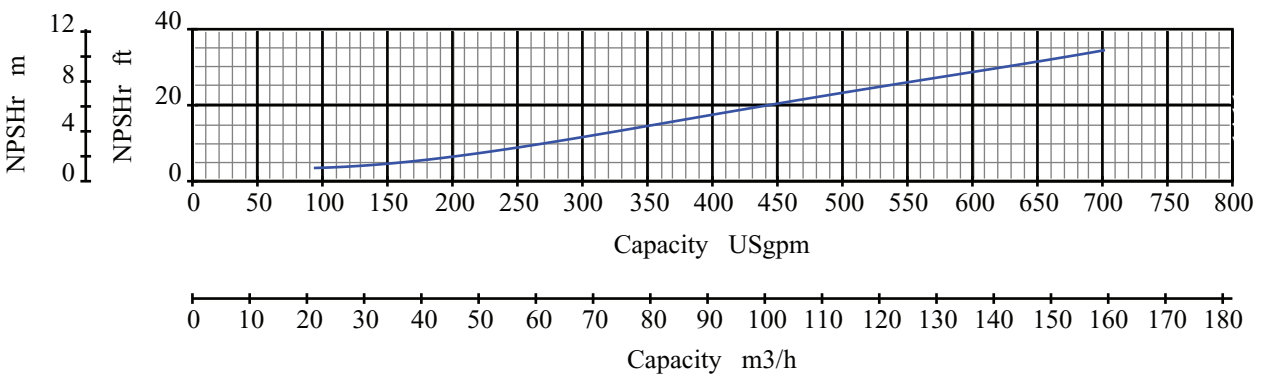
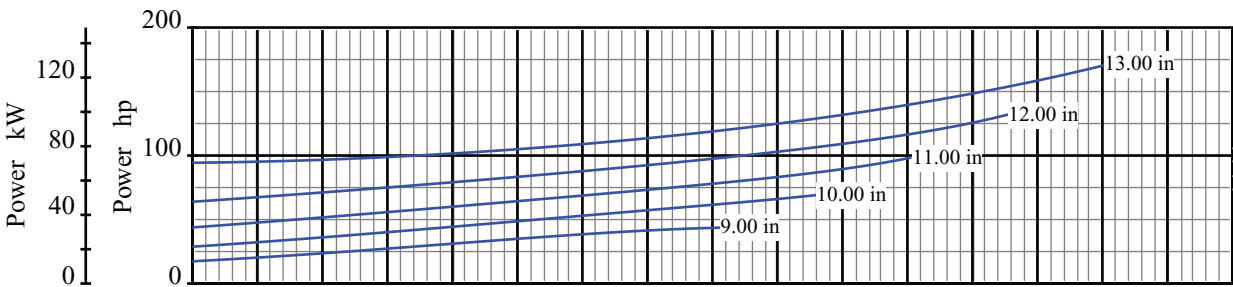
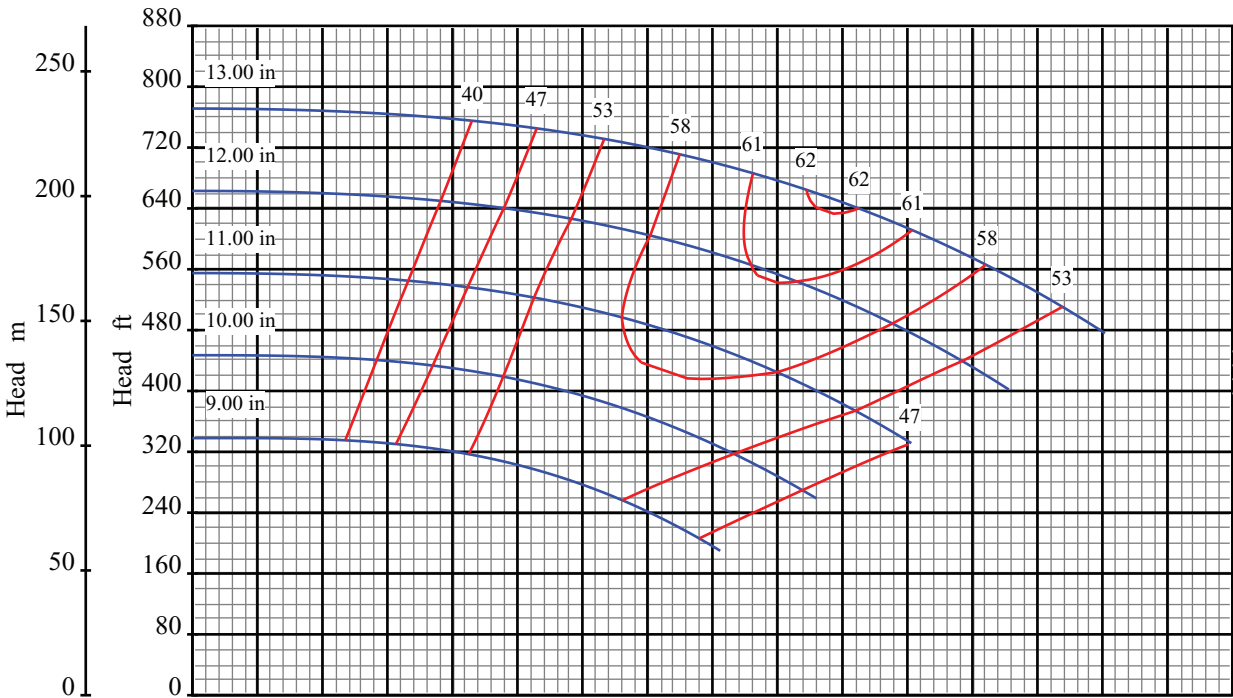

Curve No: S18184V1

Effective Date: Jan/2005

Blackmer Centrifugal

Pump Performance Characteristics

Catalog: 1301

Pump Size: 1.5x3 13

Pump Size: 40x80 330

Speed: 3550 rpm

Open Impeller

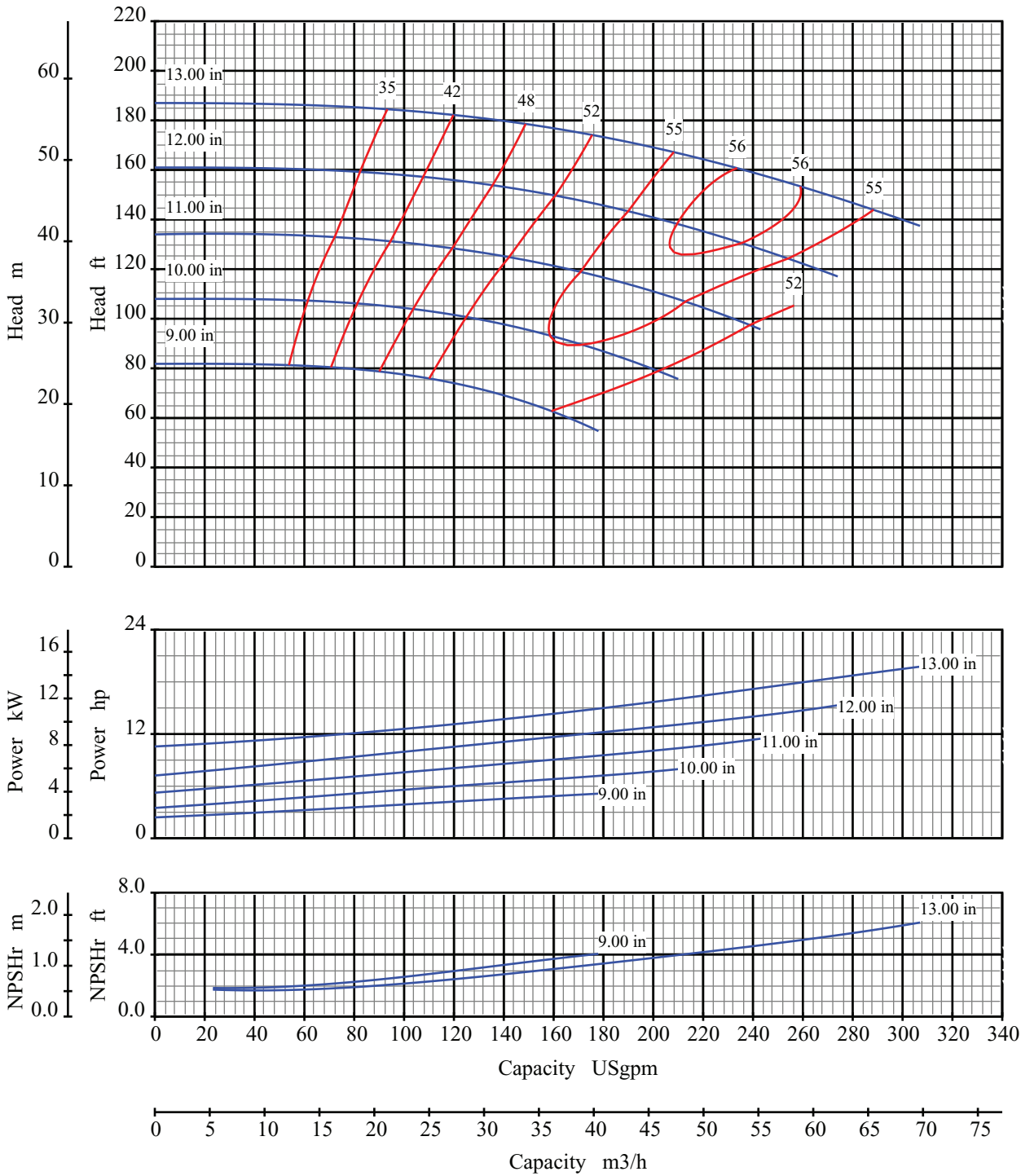

Curve No: S18186V1

Blackmer Centrifugal

Pump Performance Characteristics

Effective Date: Jan/2005

Catalog: 1301

Pump Size: 1.5x3 13

Pump Size: 40x80 330

Speed: 1750 rpm

Open Impeller

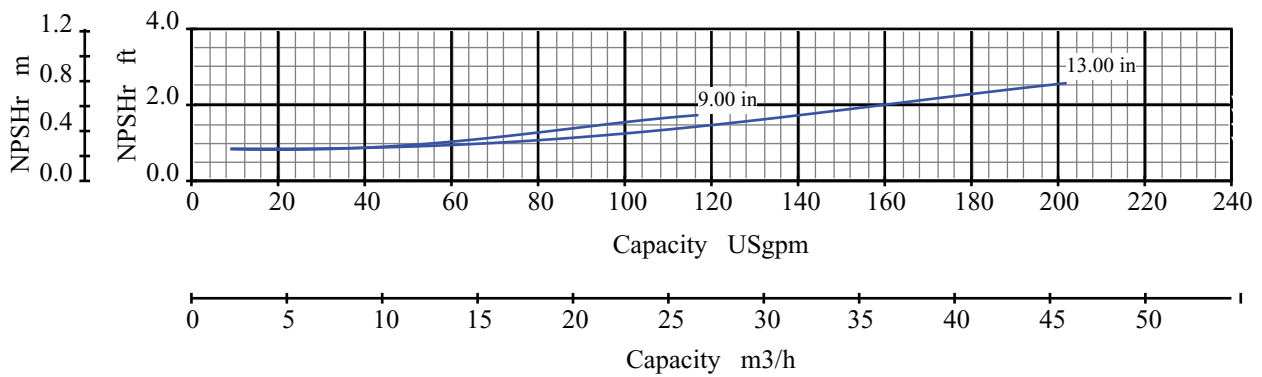
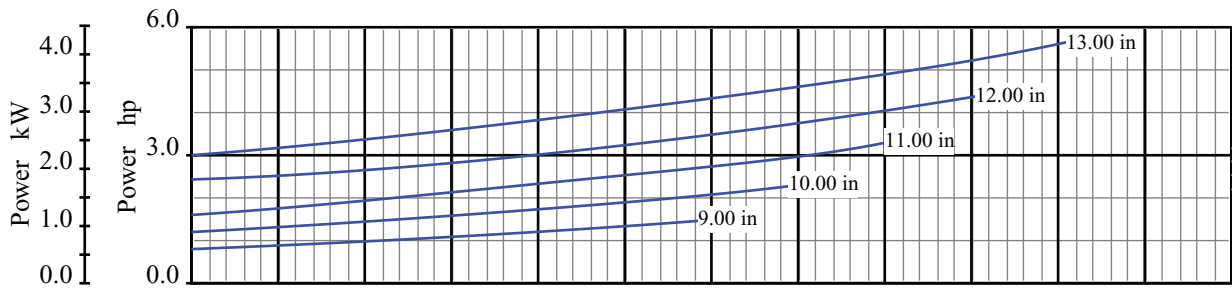
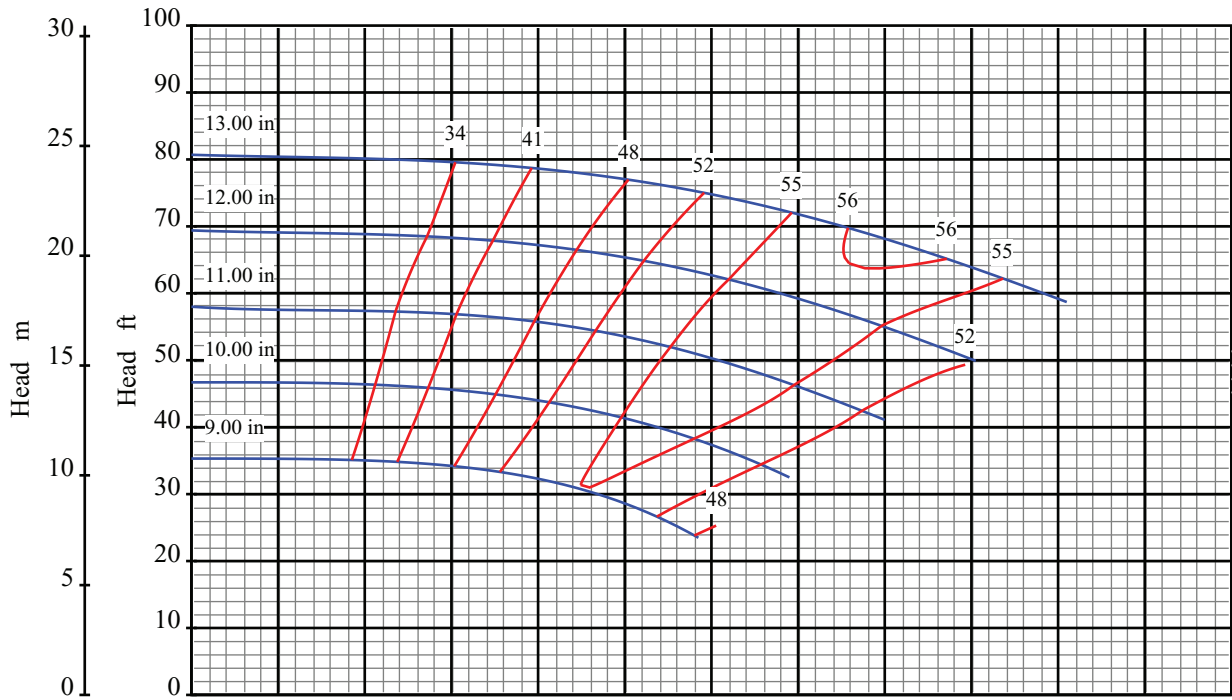

Curve No: S18188V1

Effective Date: Jan/2005

Blackmer Centrifugal

Pump Performance Characteristics

Catalog: 1301

Pump Size: 1.5x3 13

Pump Size: 40x80 330

Speed: 1150 rpm

Open Impeller

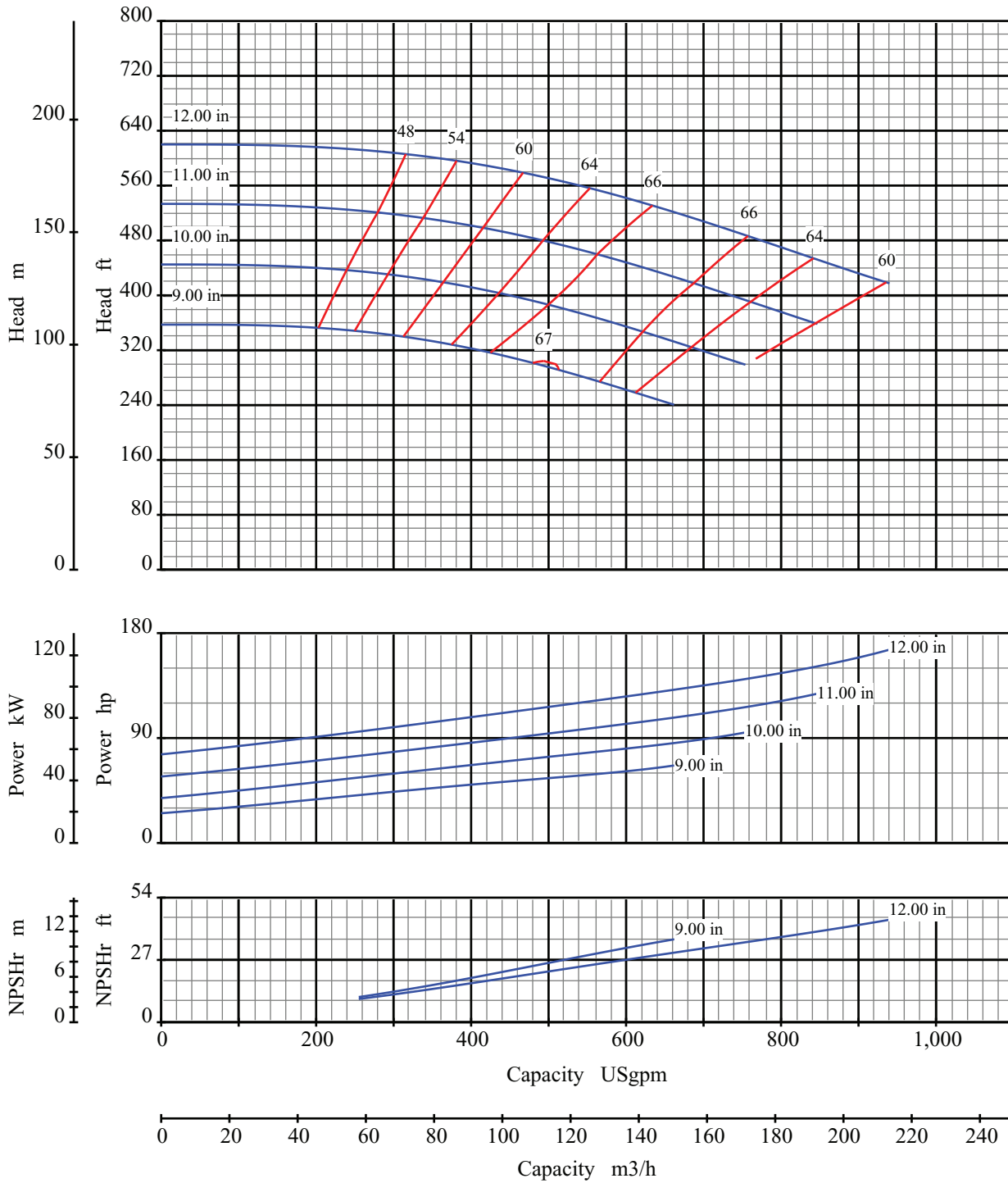

Curve No: S18190V1

Blackmer Centrifugal

Pump Performance Characteristics

Effective Date: Jan/2005

Catalog: 1301

Pump Size: 2x3 13

Pump Size: 50x80 330

Speed: 3550 rpm

Open Impeller

Blackmer® Centrifugal Composite Pump Curves | Frame A/LD17

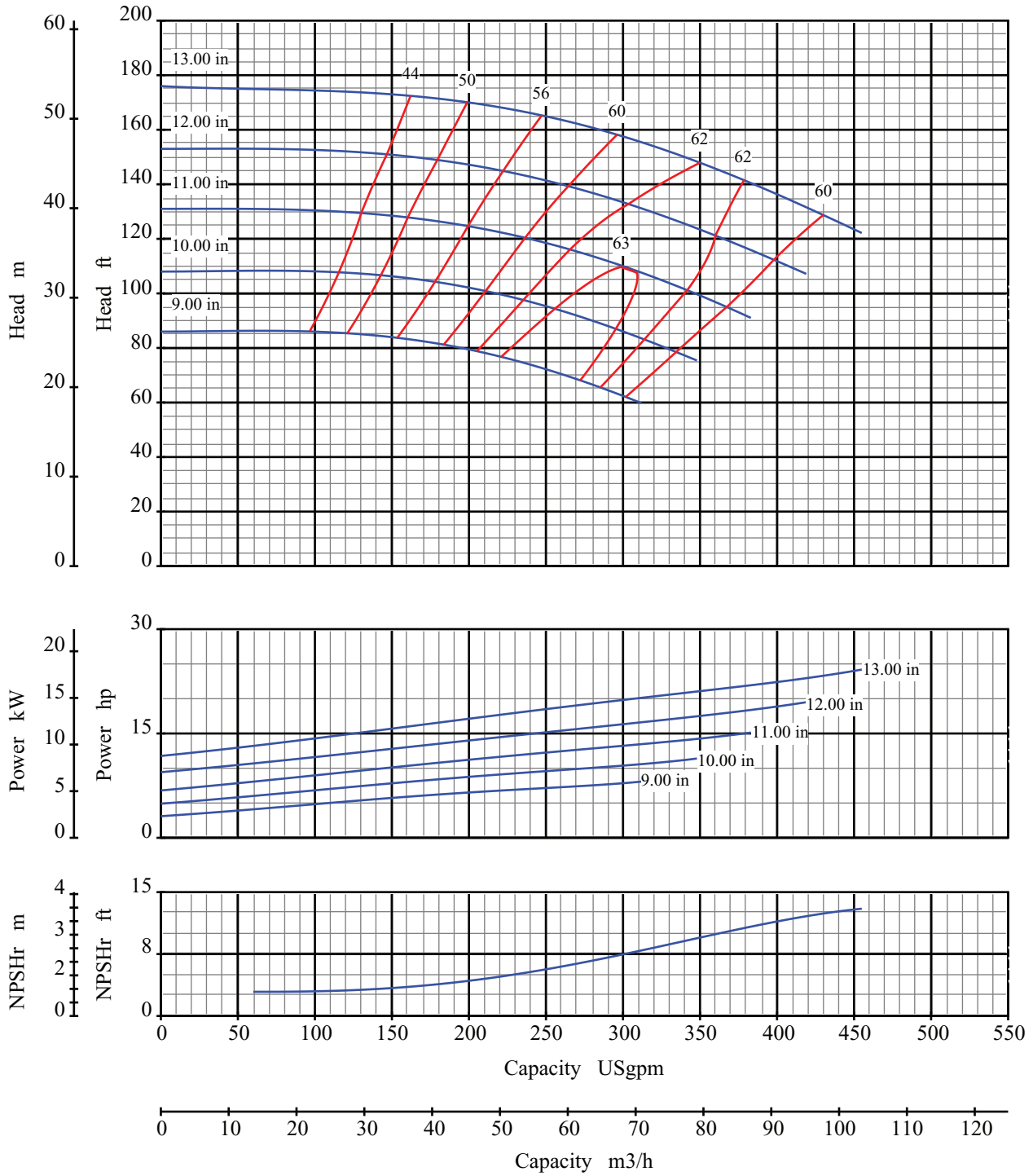

Curve No: S18192V1

Blackmer Centrifugal

Pump Performance Characteristics

Effective Date: Jan/2005

Catalog: 1301

Pump Size: 2x3 13

Pump Size: 50x80 330

Speed: 1750 rpm

Open Impeller

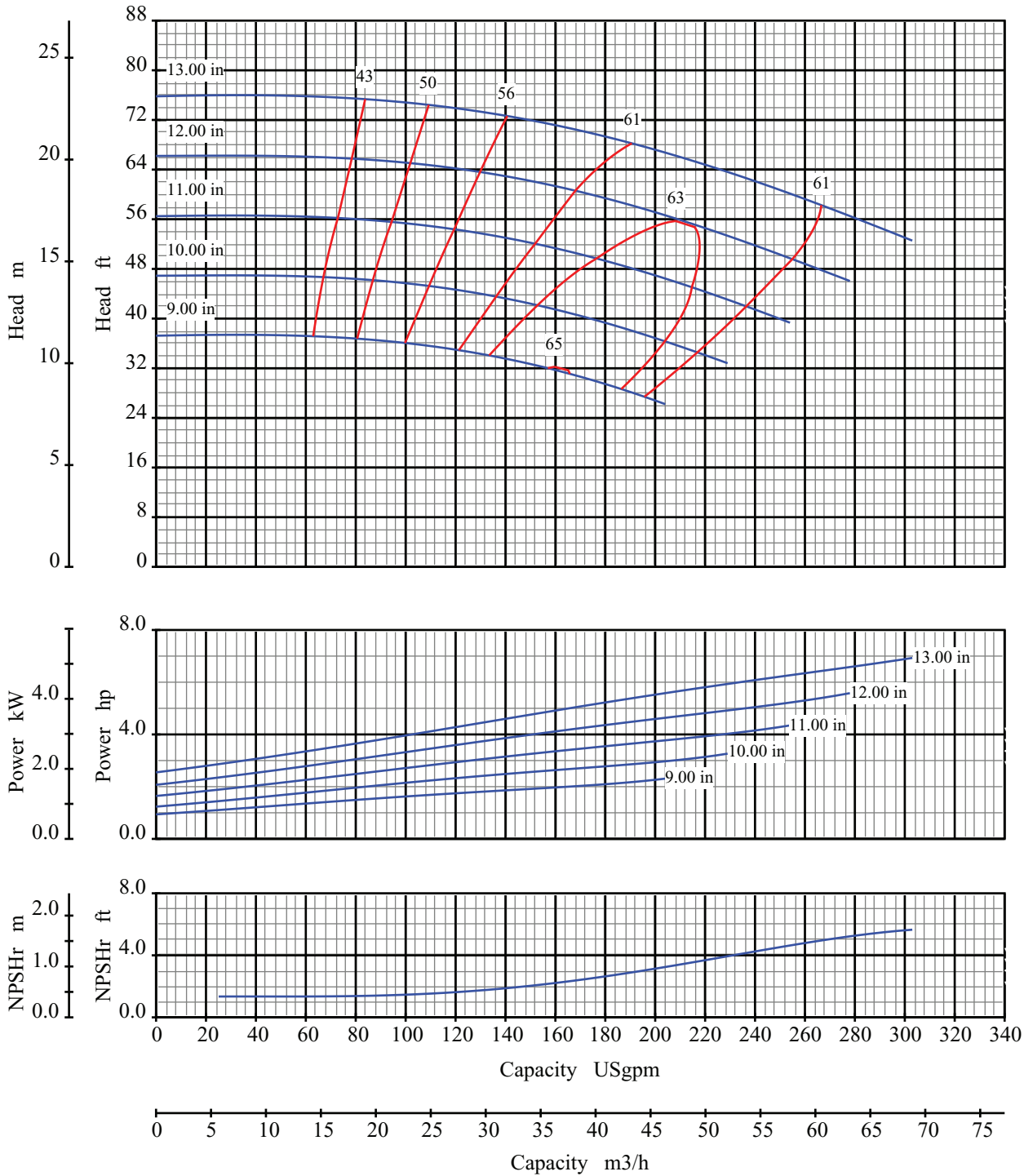

Curve No: S18194V1

Blackmer Centrifugal

Pump Performance Characteristics

Effective Date: Jan/2005

Catalog: 1301

Pump Size: 2x3 13

Pump Size: 50x80 330

Speed: 1150 rpm

Open Impeller

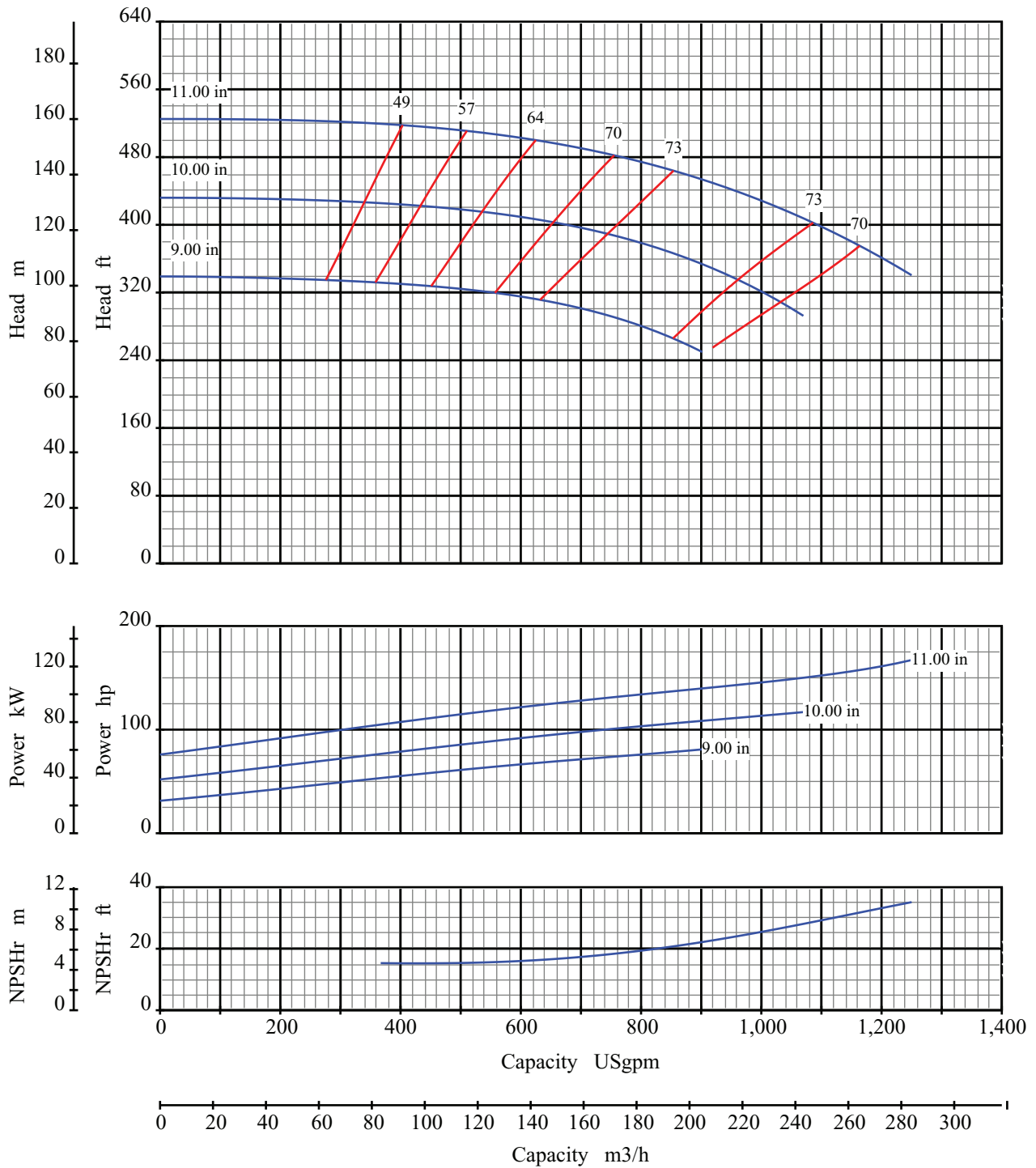

Curve No: S18196V1

Effective Date: Jan/2005

Blackmer Centrifugal

Pump Performance Characteristics

Catalog: 1301

Pump Size: 3x4 13

Pump Size: 80x100 330

Speed: 3550 rpm

Open Impeller

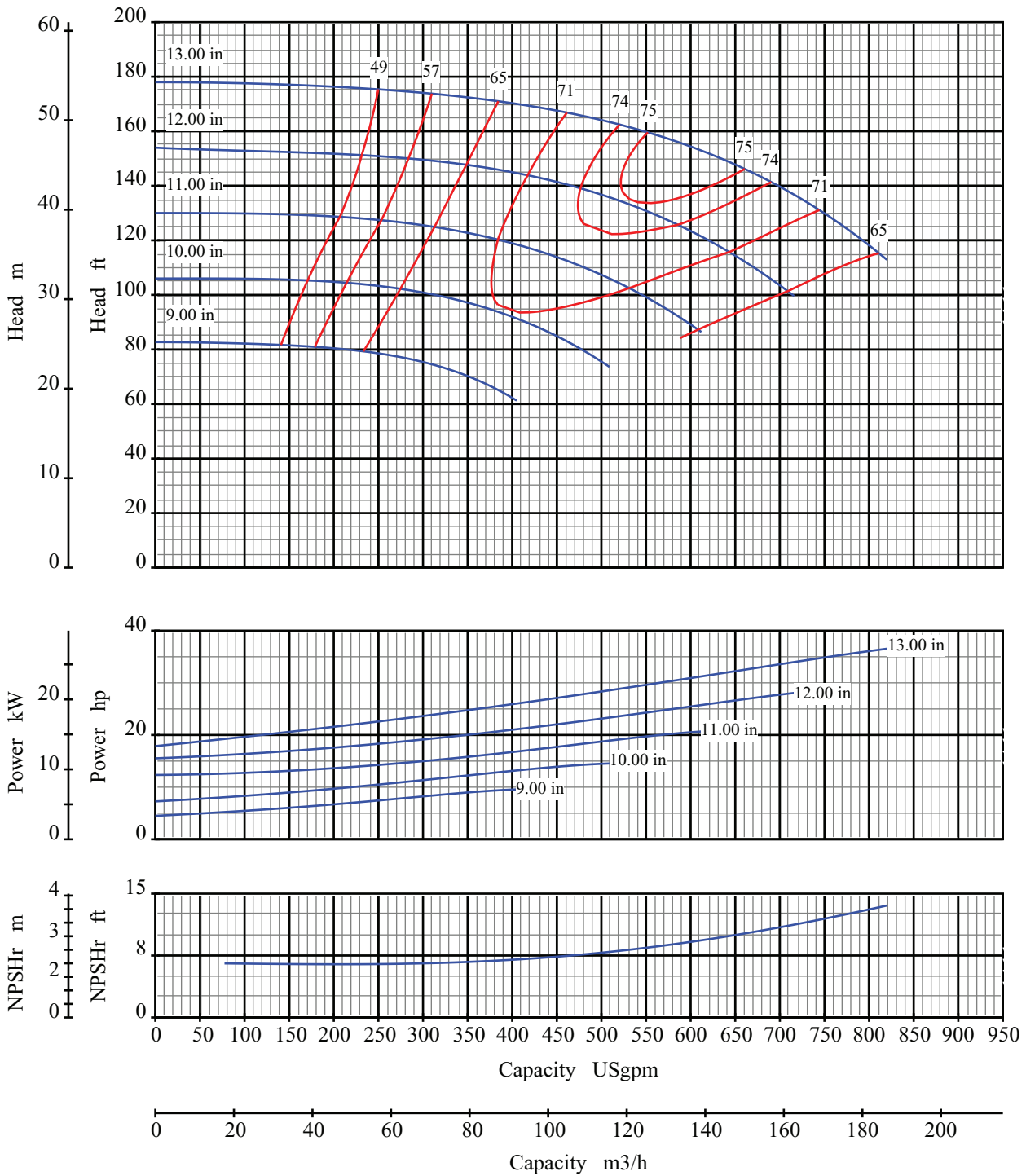

Curve No: S18198V1

Blackmer Centrifugal

Pump Size: 3x4 13

Pump Performance Characteristics

Pump Size: 80x100 330

Effective Date: Jan/2005

Catalog: 1301

Speed: 1750 rpm

Open Impeller

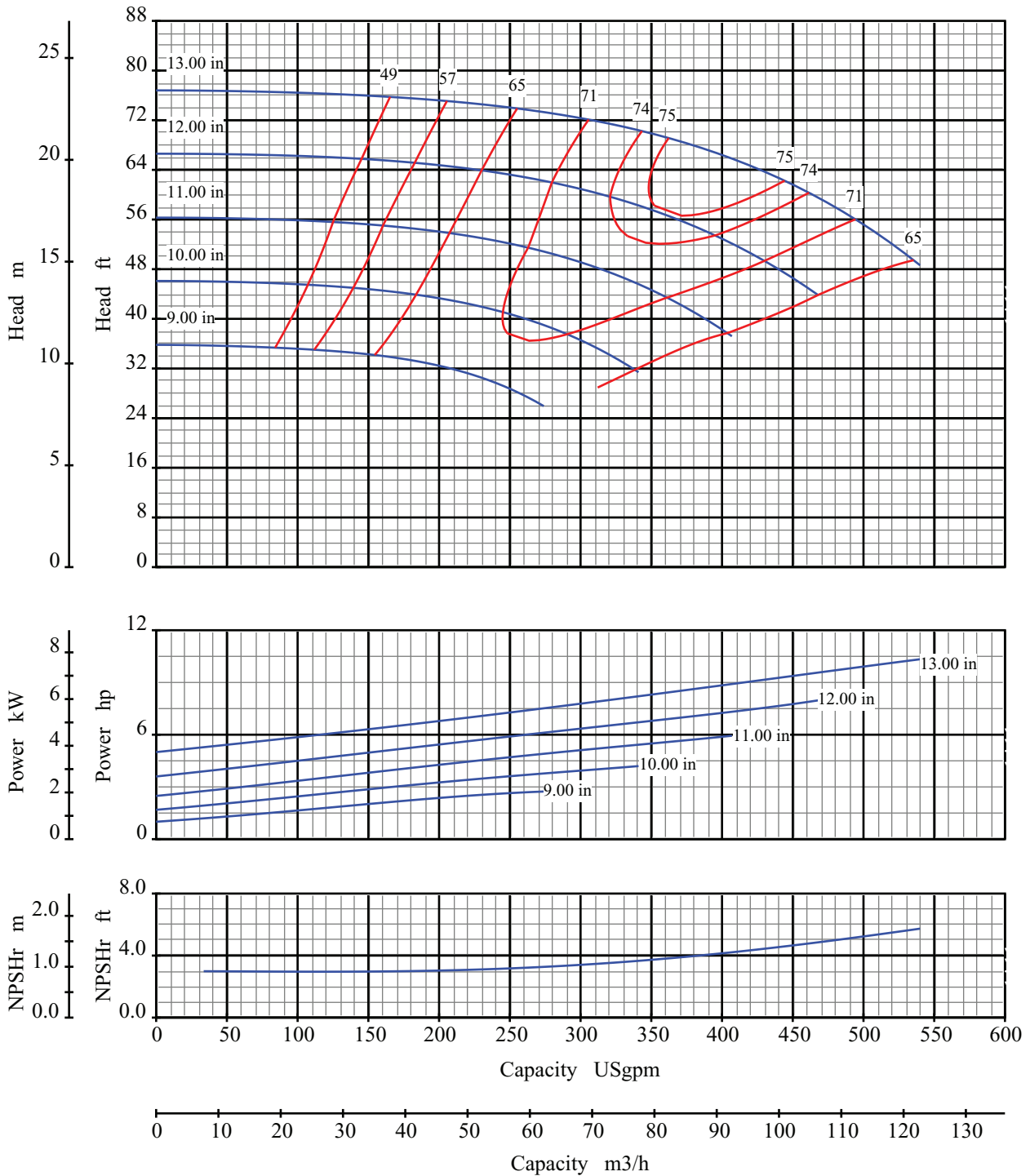

Curve No: S18200V1

Effective Date: Jan/2005

Blackmer Centrifugal

Pump Performance Characteristics

Catalog: 1301

Pump Size: 3x4 13

Pump Size: 80x100 330

Speed: 1150 rpm

Open Impeller

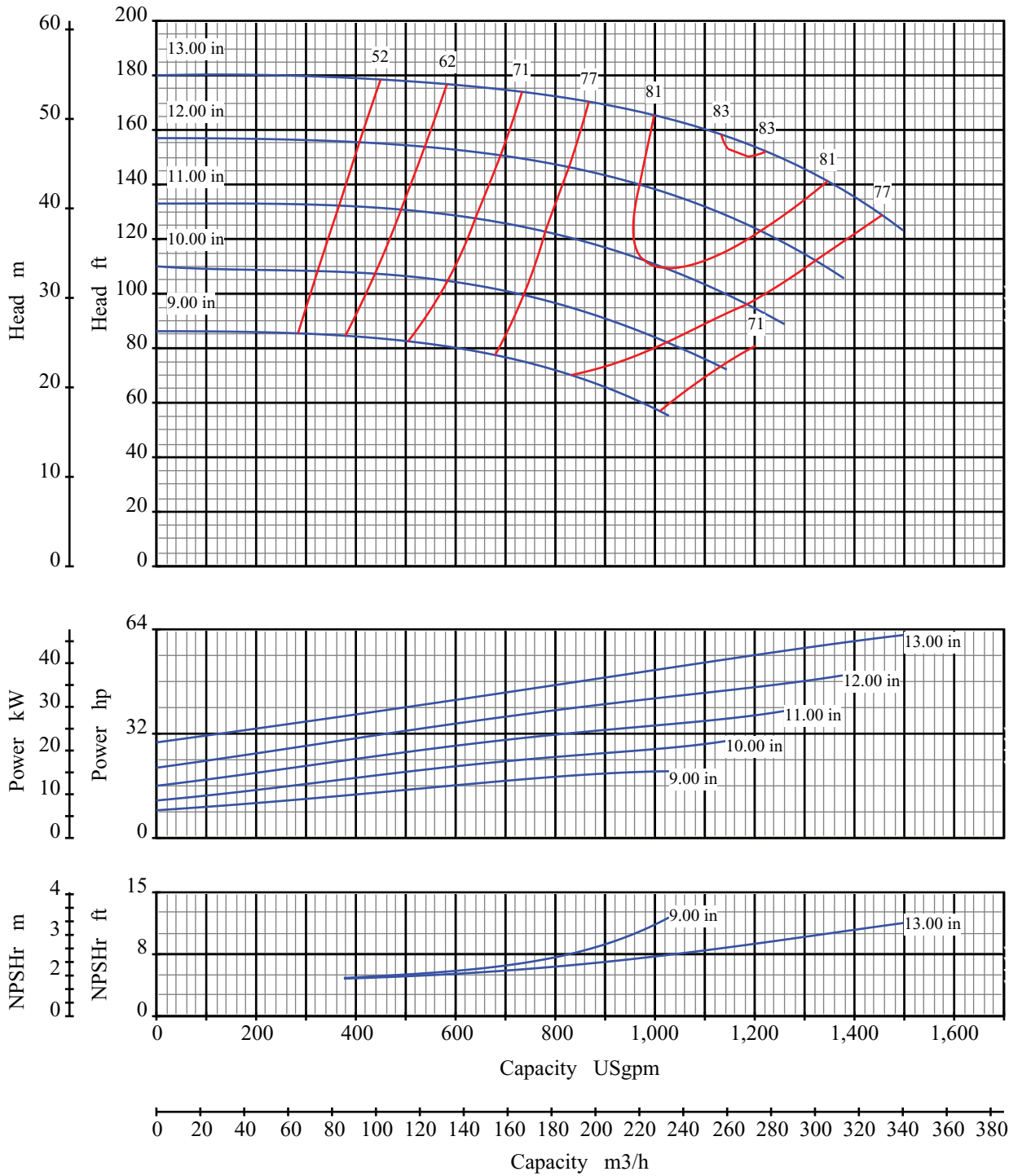

Curve No: S18204V1

Blackmer Centrifugal

Pump Size: 4x6 13

Pump Performance Characteristics

Pump Size: 100 150 330

Effective Date: Jan/2005

Catalog: 1301

Speed: 1750 rpm

Open Impeller

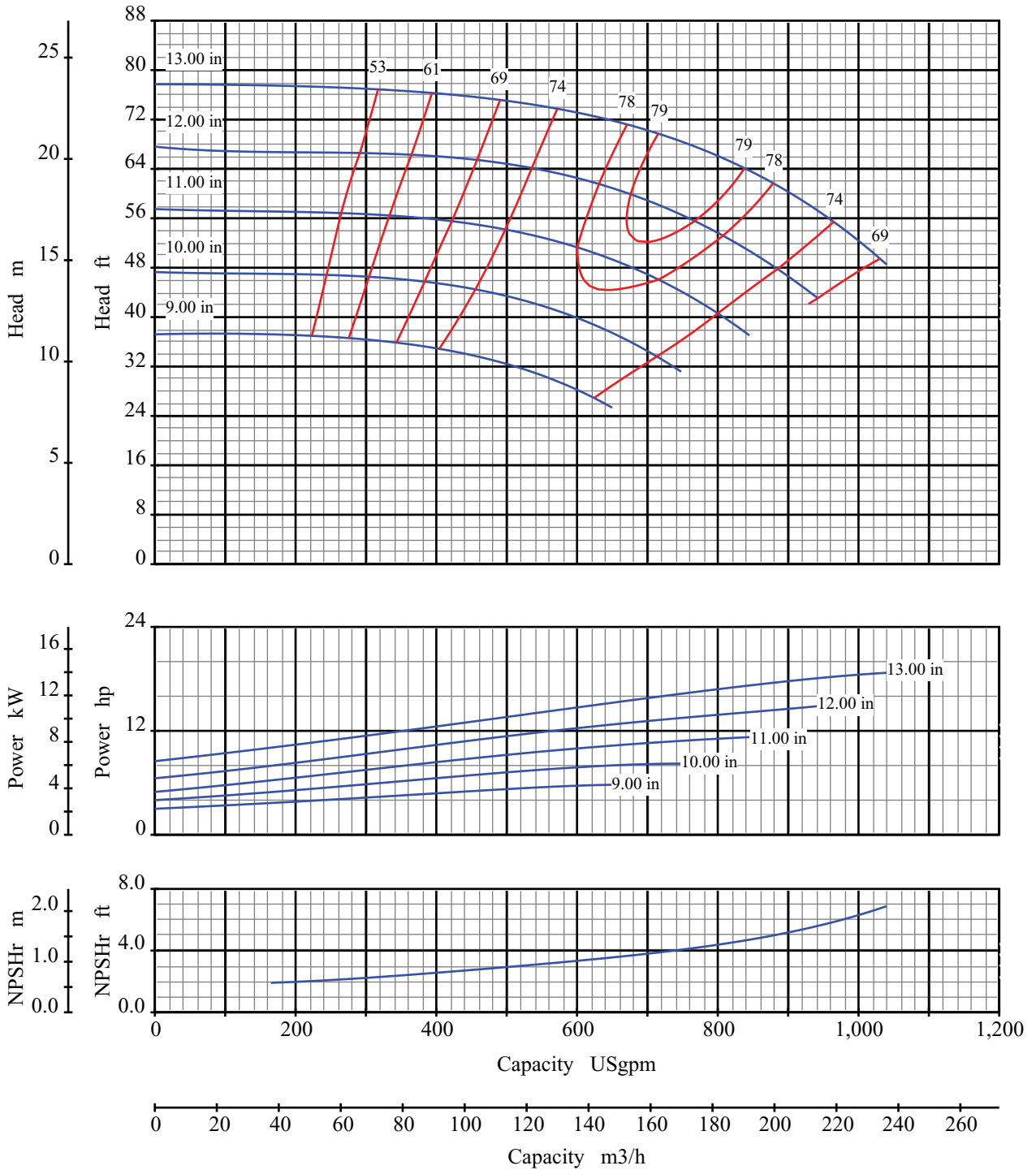

Curve No: S18206V1

Effective Date: Jan/2005

Blackmer Centrifugal

Pump Performance Characteristics

Catalog: 1301

Pump Size: 4x6 13

Pump Size: 100 150 330

Speed: 1150 rpm

Open Impeller

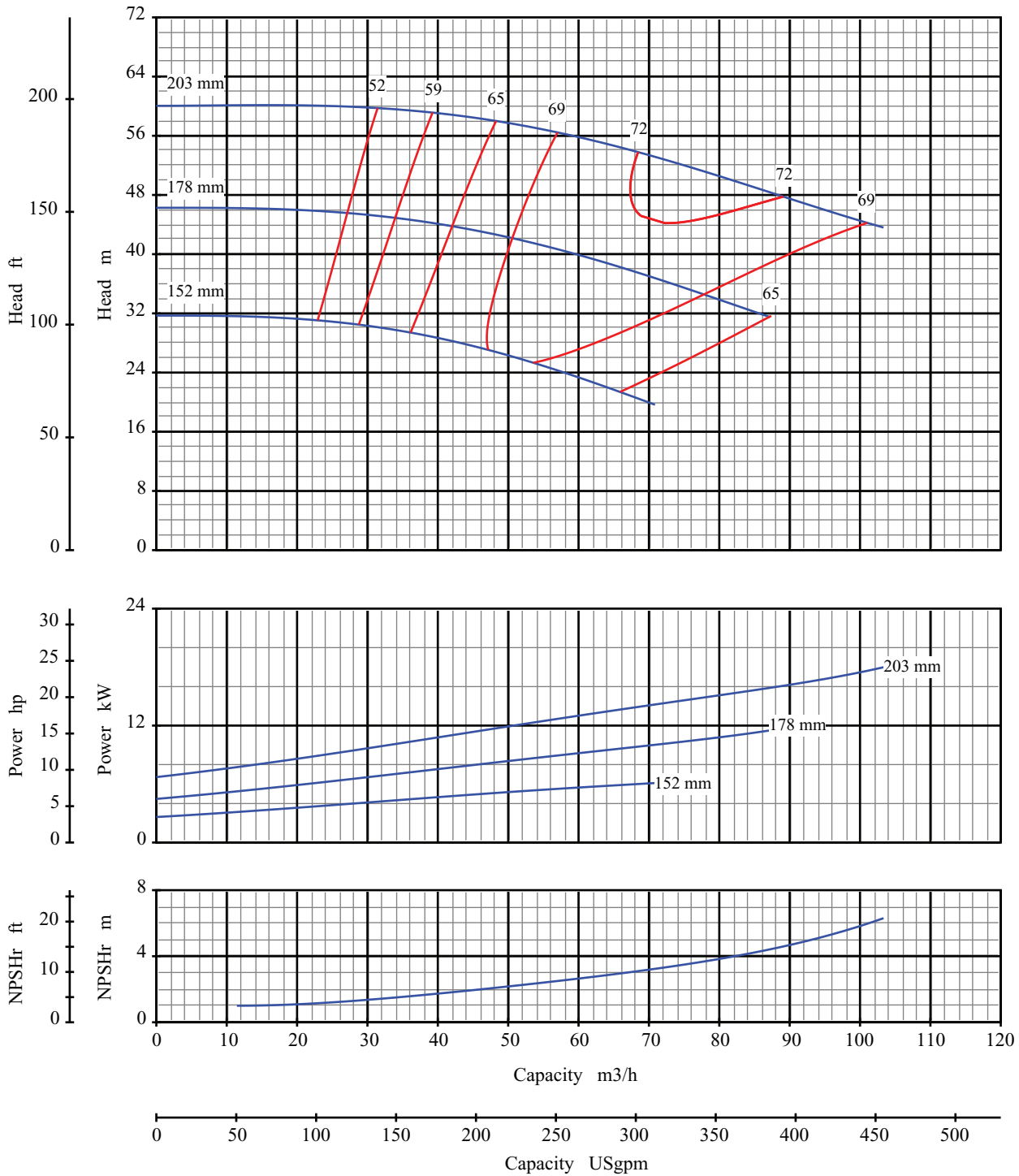

Curve No: S18143V1

Blackmer Centrifugal

Pump Performance Characteristics

Effective Date: Jan/2005

Catalog: 1301

Pump Size: 50x80 200

Pump Size: 2x3 8

Speed: 2900 rpm

Open Impeller

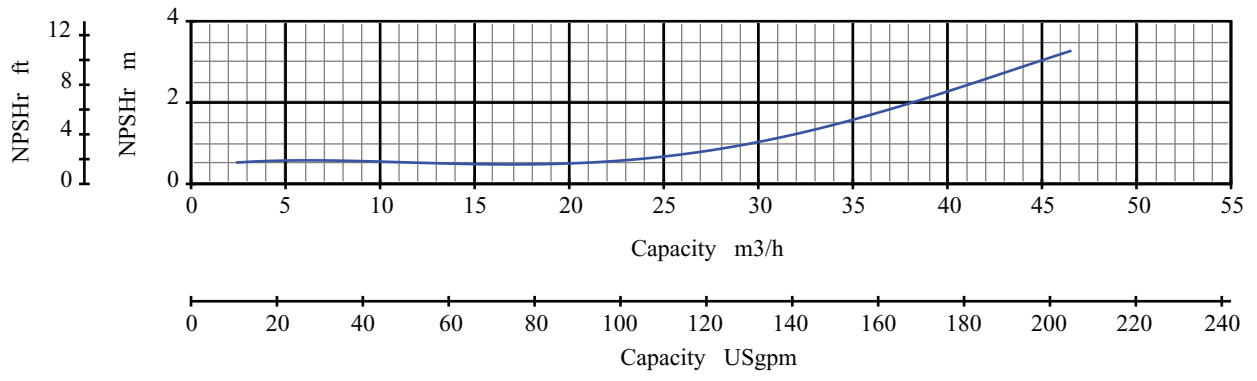
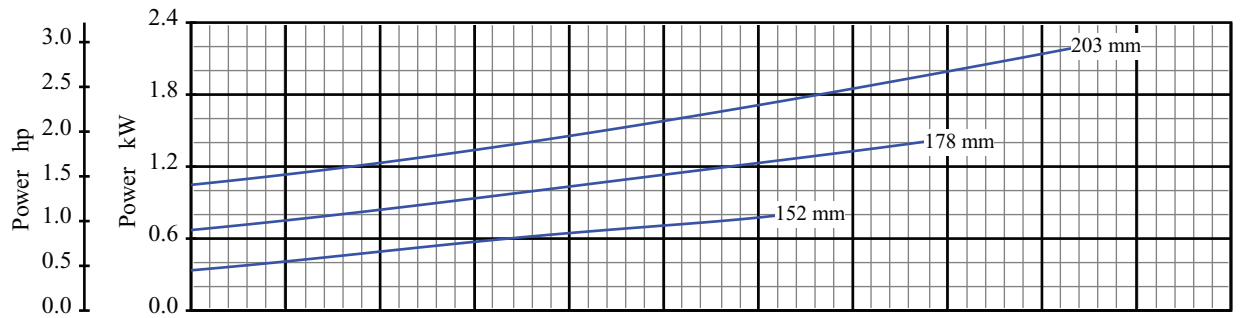
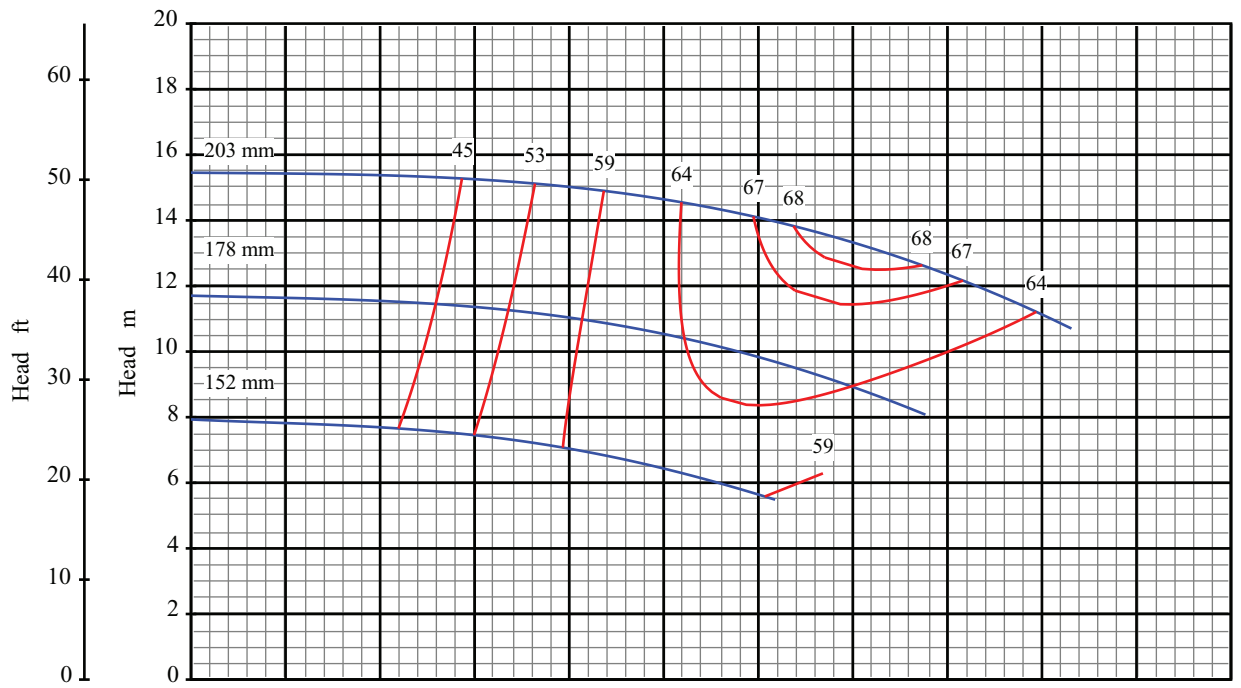

Curve No: S18145V1

Blackmer Centrifugal

Pump Size: 50x80 200

Pump Performance Characteristics

Pump Size: 2x3 8

Effective Date: Jan/2005

Catalog: 1301

Speed: 1450 rpm

Open Impeller

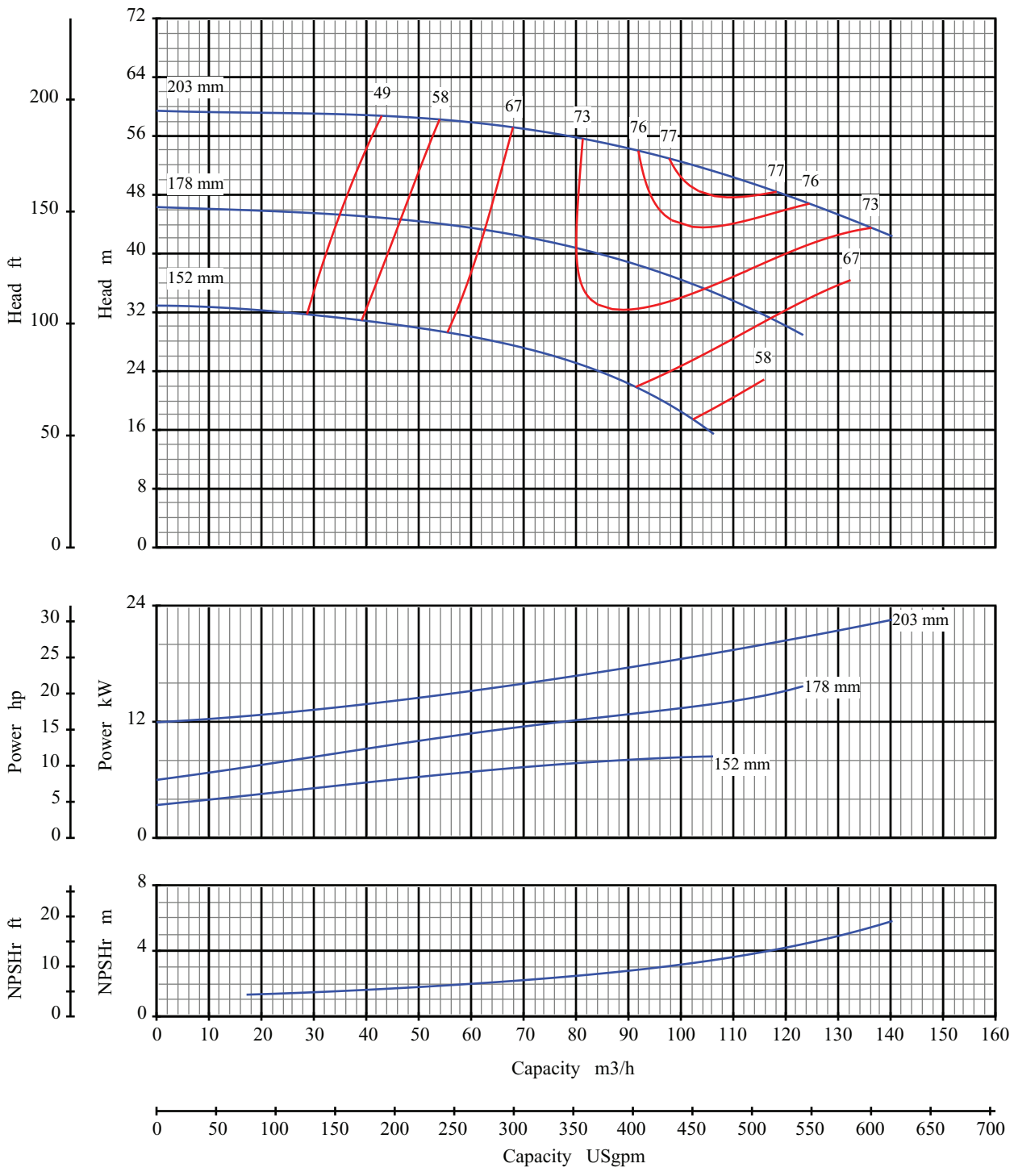

Curve No: S18149V1

Blackmer Centrifugal

Pump Size: 80x100 200

Pump Performance Characteristics

Pump Size: 3x4 8

Effective Date: Jan/2005

Catalog: 1301

Speed: 2900 rpm

Open Impeller

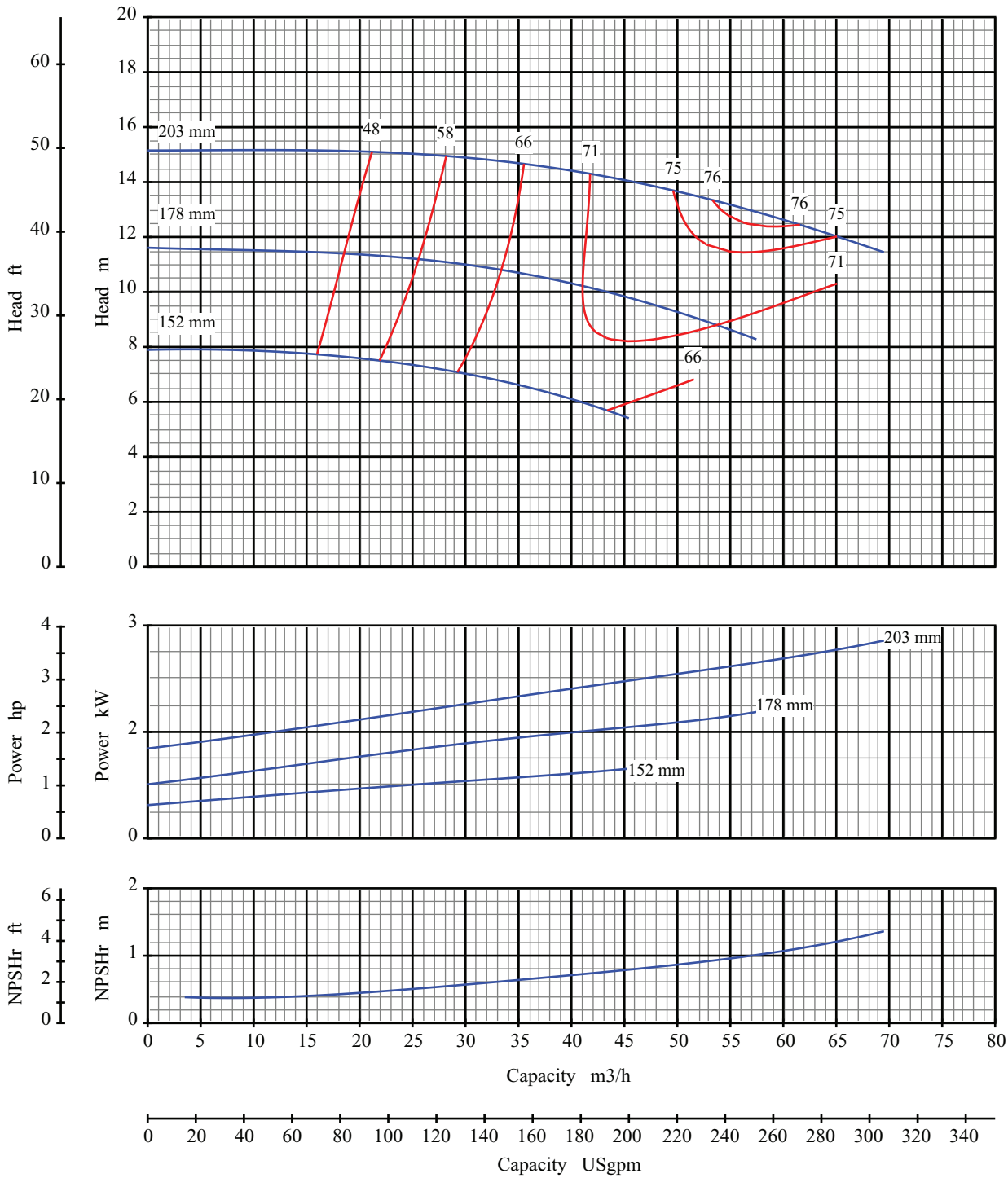

Curve No: S18151V1

Blackmer Centrifugal

Pump Size: 80x100 200

Pump Performance Characteristics

Pump Size: 3x4 8

Effective Date: Jan/2005

Catalog: 1301

Speed: 1450 rpm

Open Impeller

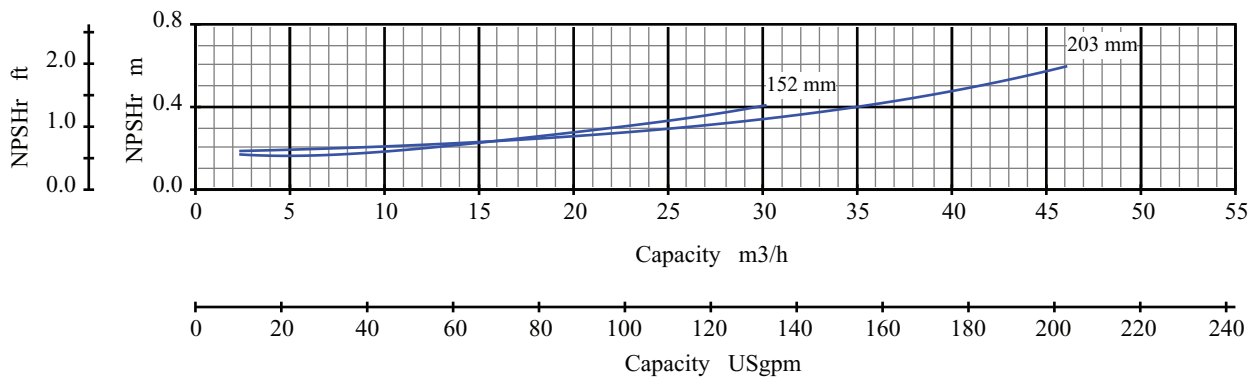
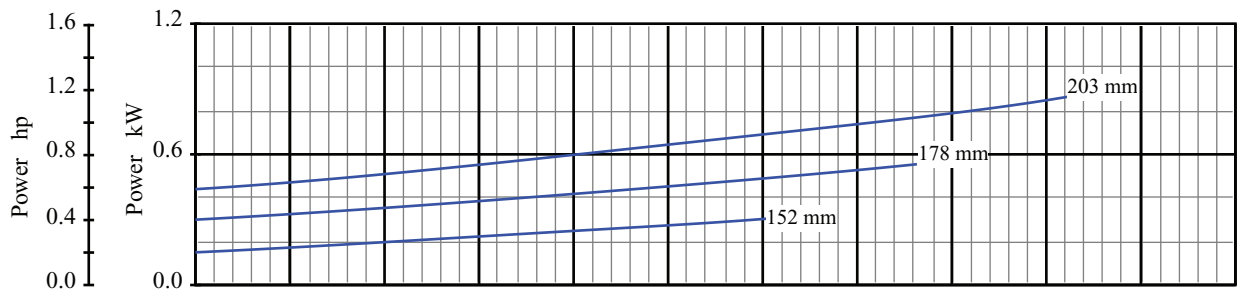
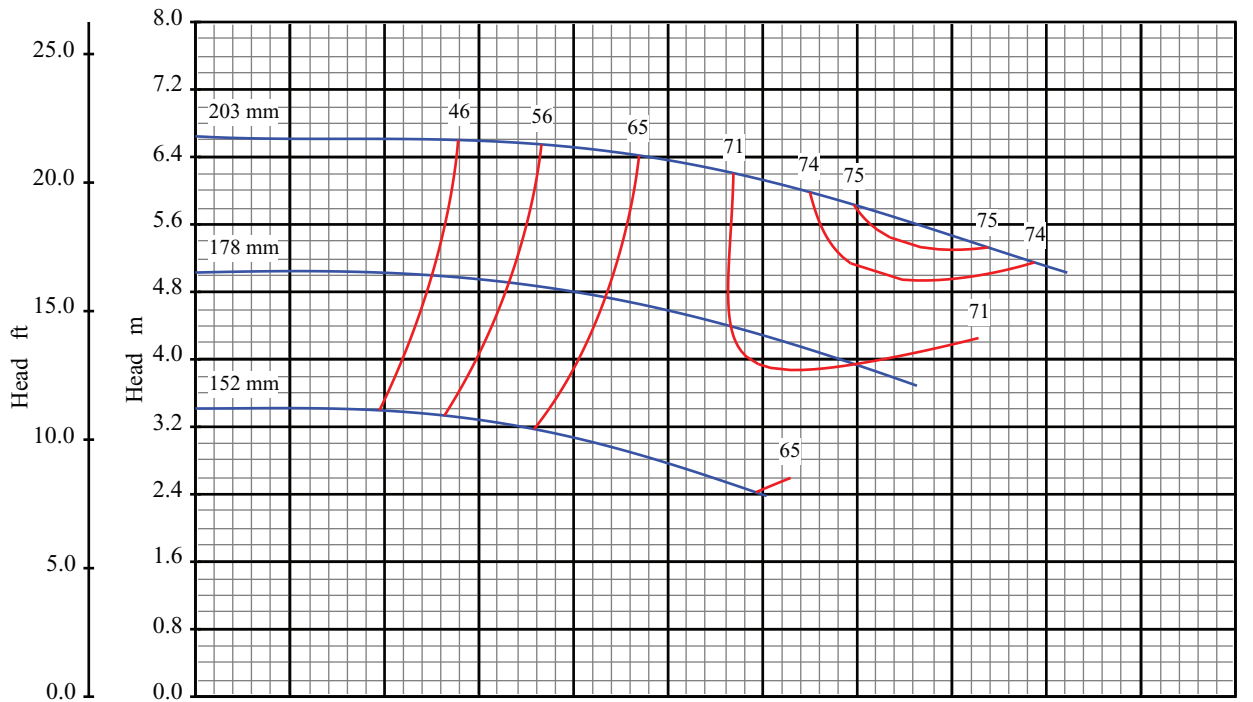

Curve No: S18153V1

Effective Date: Jan/2005

Blackmer Centrifugal

Pump Performance Characteristics

Catalog: 1301

Pump Size: 80x100 200

Pump Size: 3x4 8

Speed: 960 rpm

Open Impeller

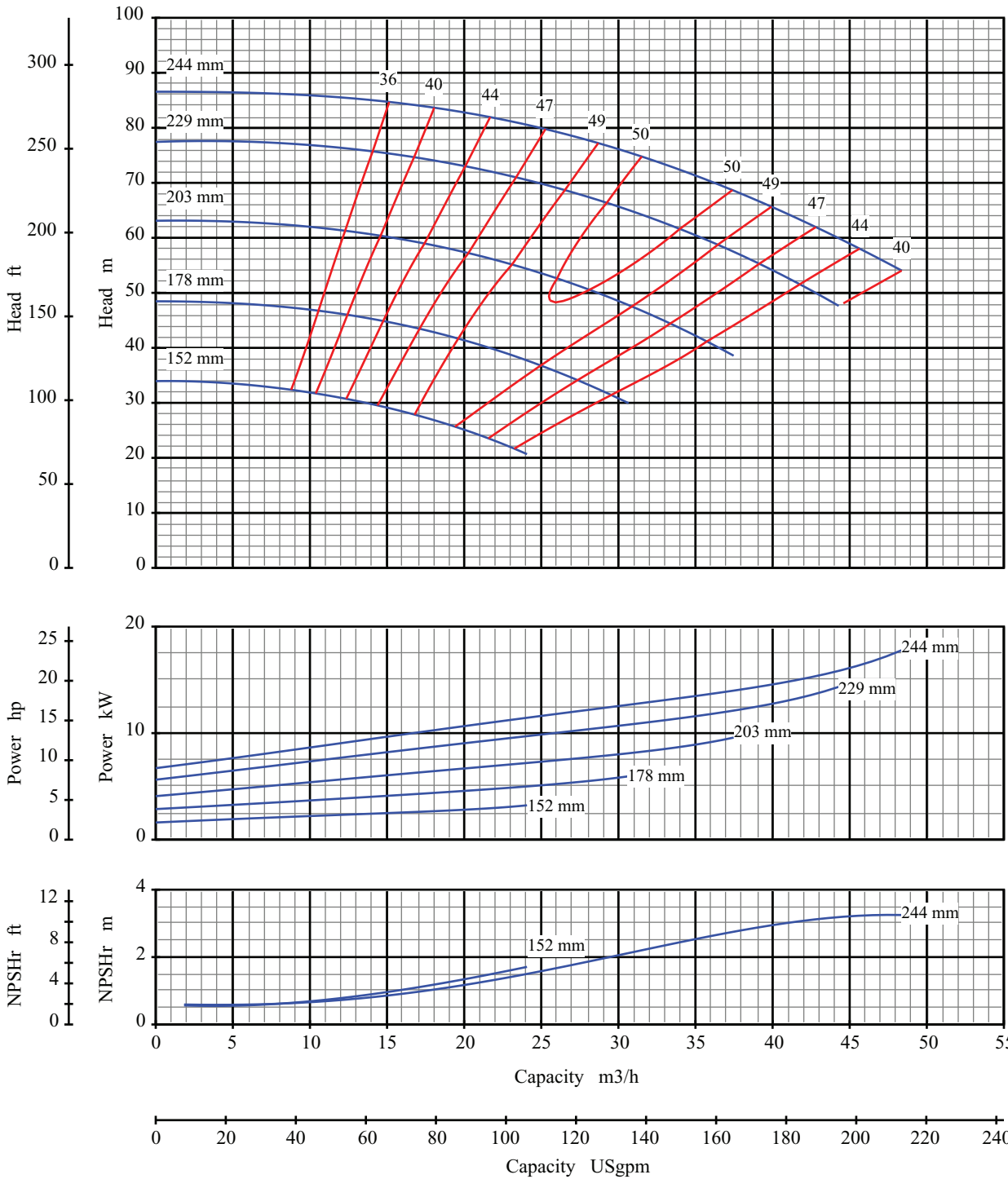

Curve No: S18155V1

Blackmer Centrifugal

Pump Performance Characteristics

Effective Date: Jan/2005

Catalog: 1301

Pump Size: 25x50 250

Pump Size: 1x2 10

Speed: 2900 rpm

Open Impeller

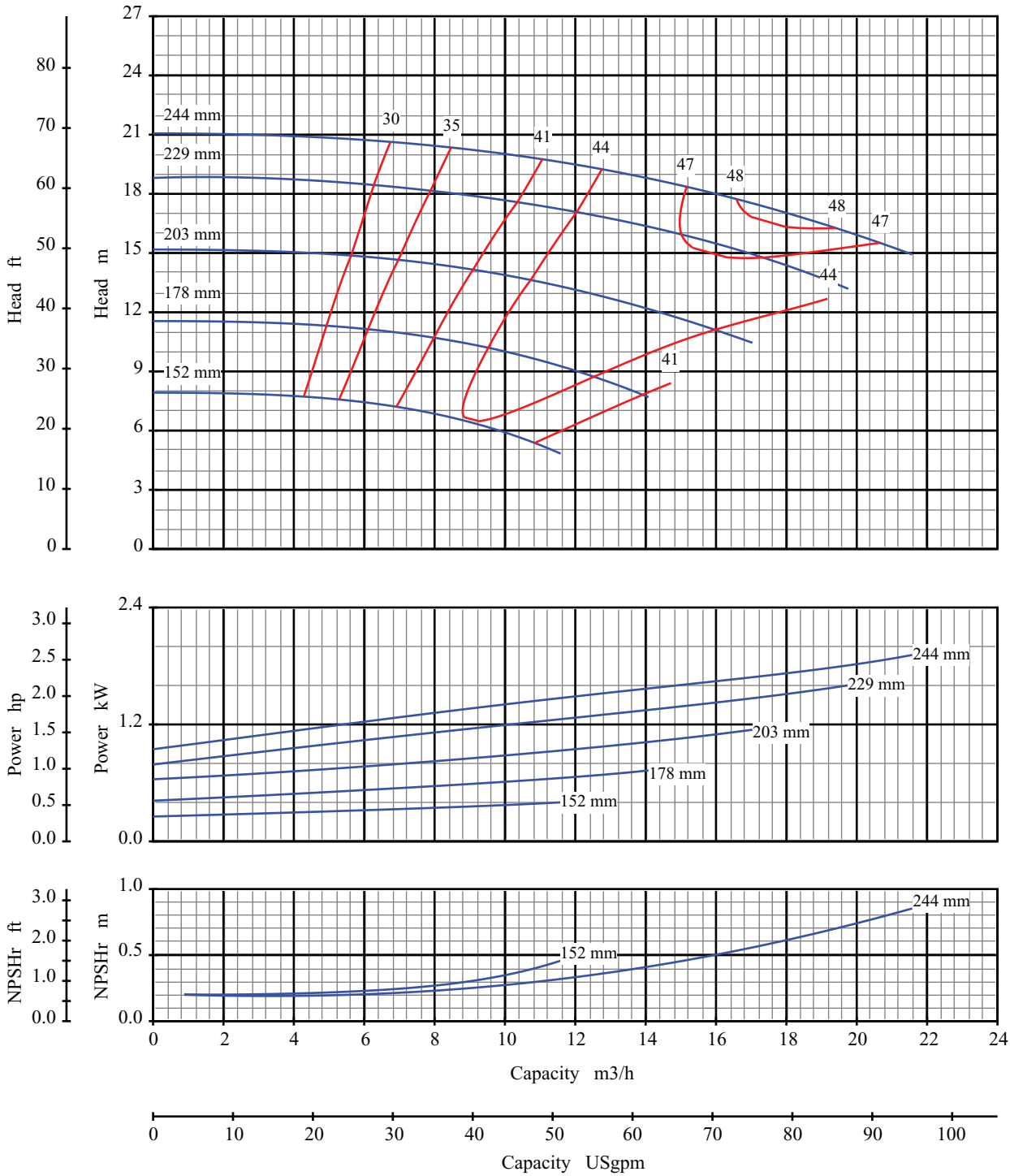

Curve No: S18157V1

Effective Date: Jan/2005

Blackmer Centrifugal

Pump Performance Characteristics

Catalog: 1301

Pump Size: 25x50 250

Pump Size: 1x2 10

Speed: 1450 rpm

Open Impeller

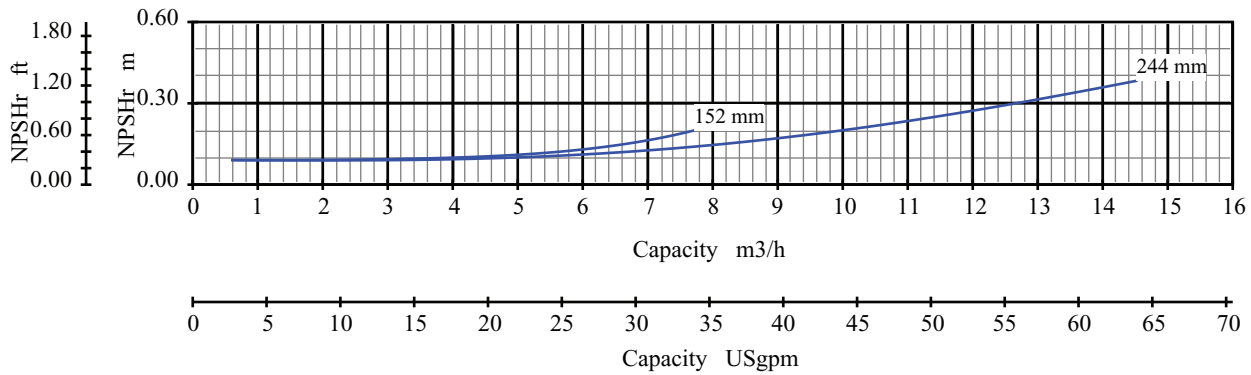
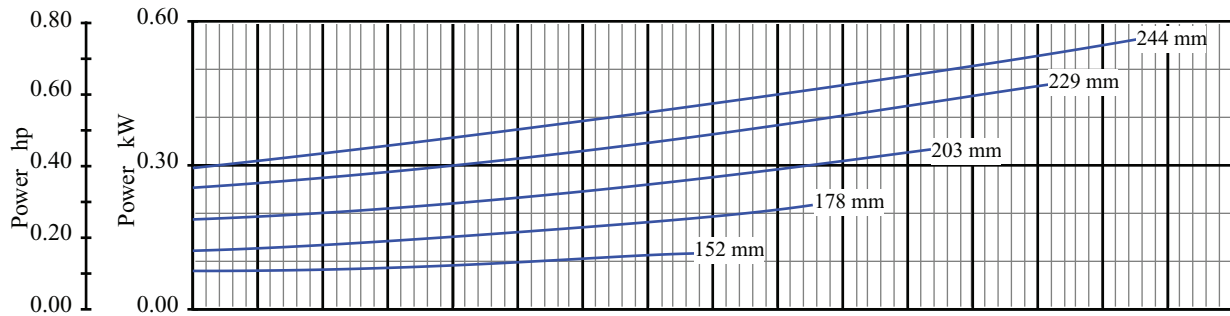
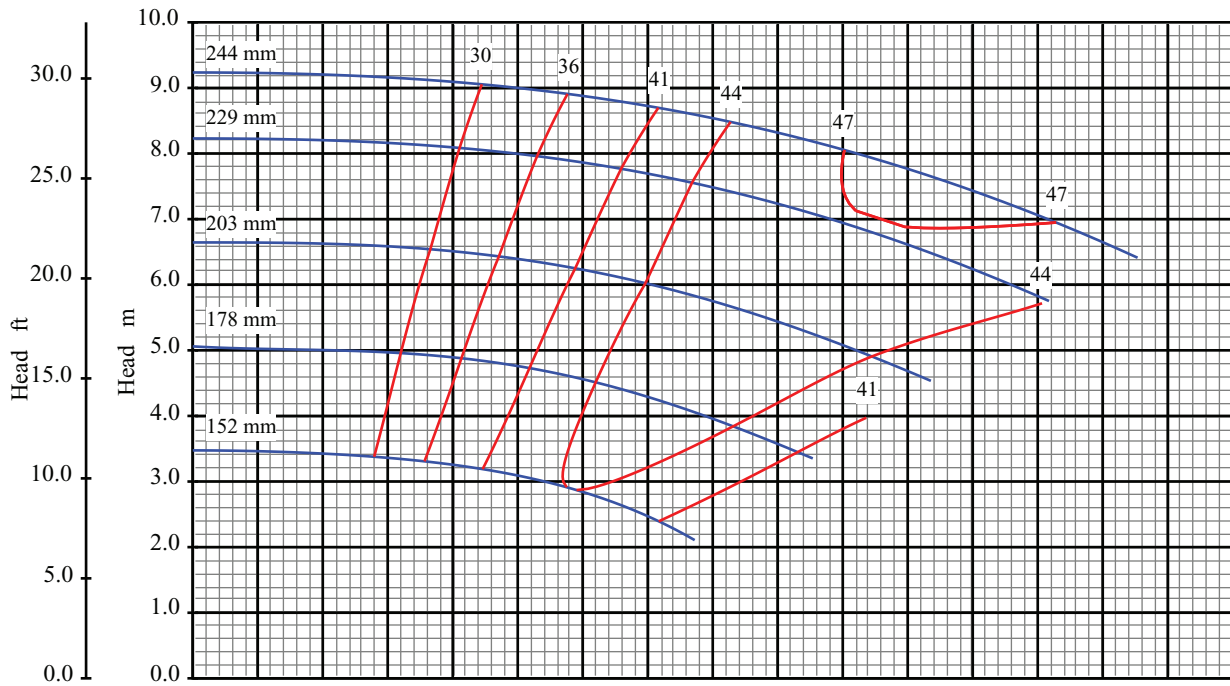

Curve No: S18159V1

Blackmer Centrifugal

Pump Size: 25x50 250

Pump Performance Characteristics

Pump Size: 1x2 10

Effective Date: Jan/2005

Catalog: 1301

Speed: 960 rpm

Open Impeller

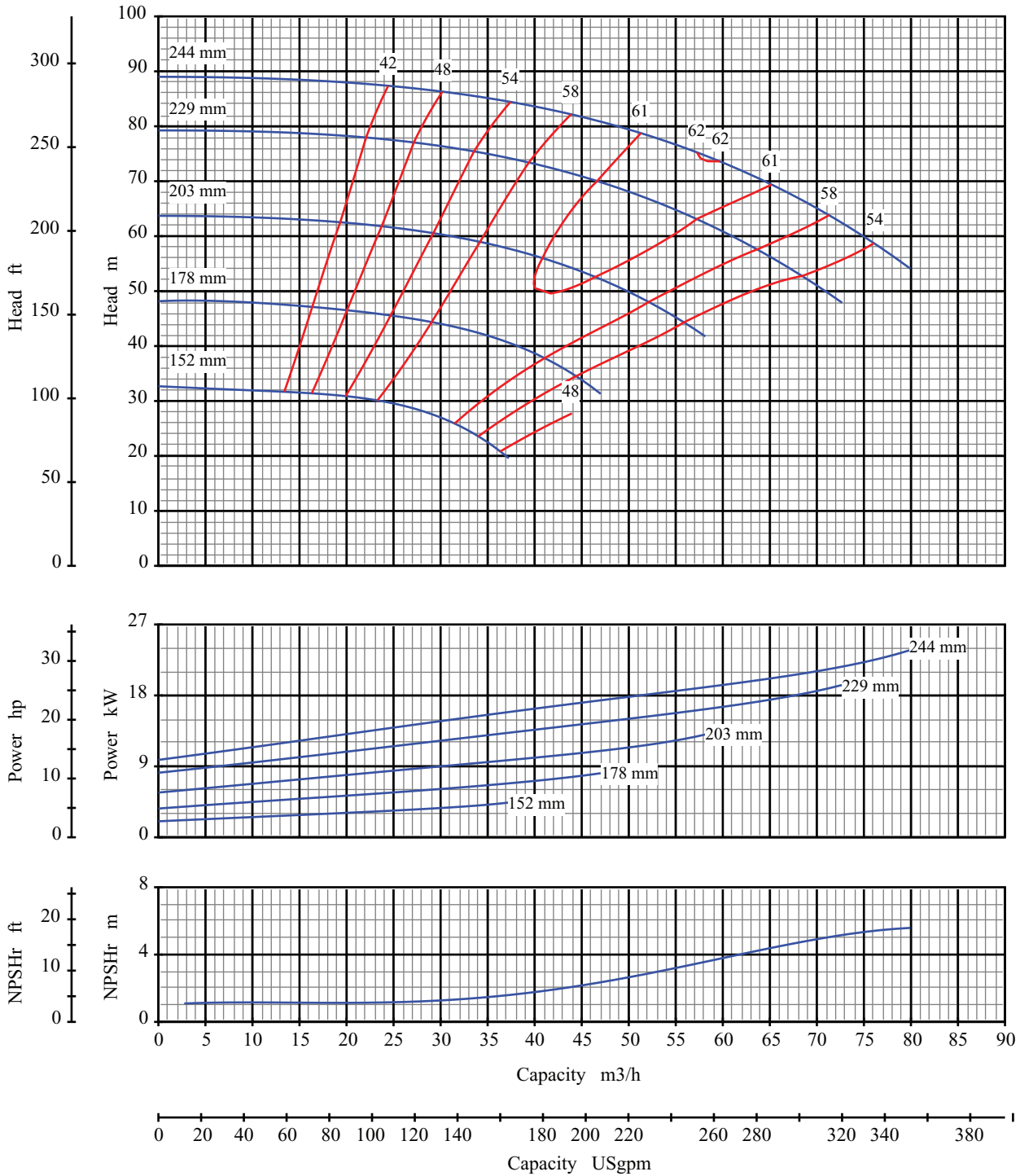

Curve No: S18161V1

Blackmer Centrifugal

Pump Performance Characteristics

Catalog: 1301

Effective Date: Jan/2005

Pump Size: 40x80 250

Pump Size: 1.5x3 10

Speed: 2900 rpm

Open Impeller

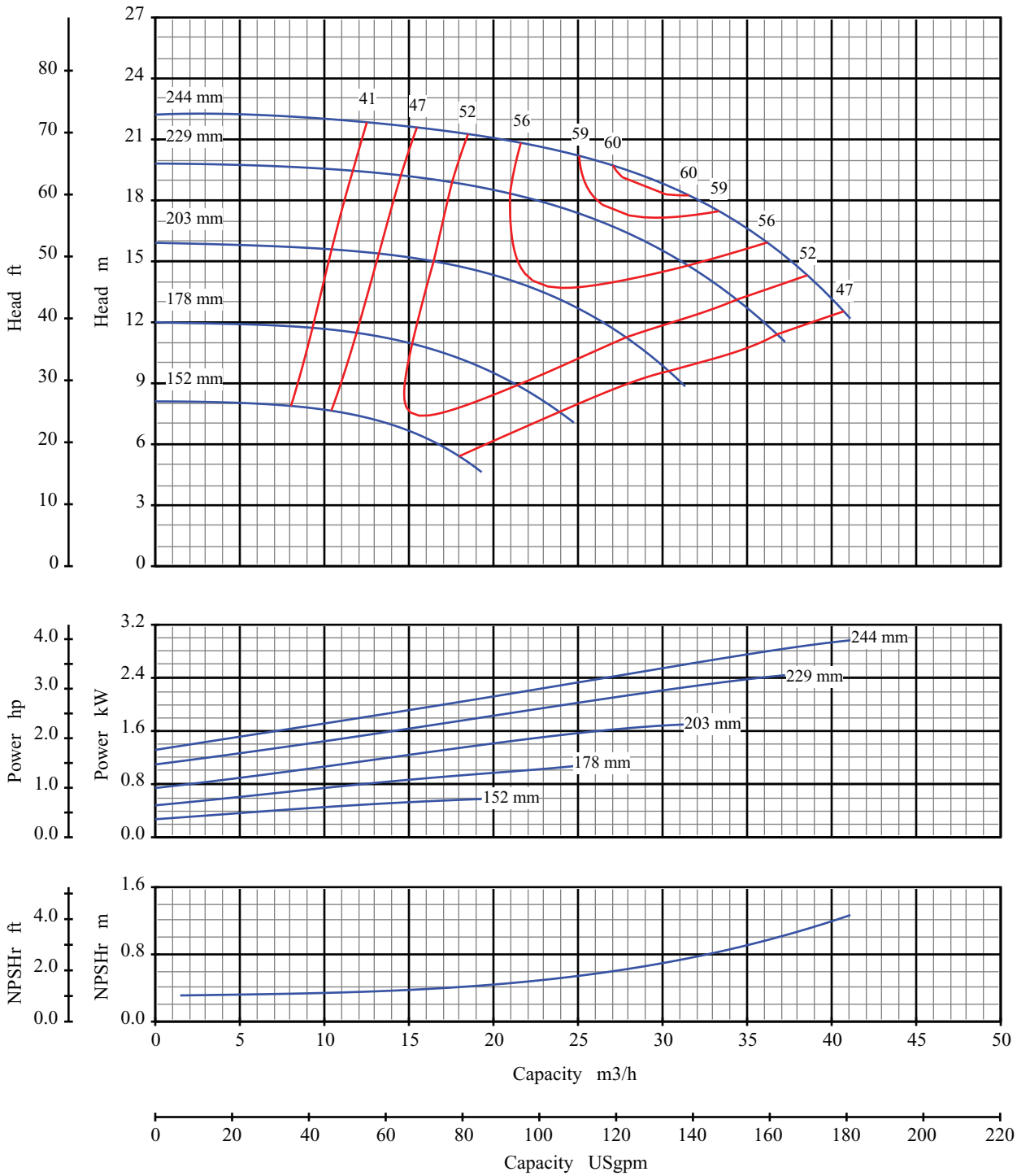

Curve No: S18163V1

Blackmer Centrifugal

Pump Size: 40x80 250

Pump Performance Characteristics

Pump Size: 1.5x3 10

Effective Date: Jan/2005

Catalog: 1301

Speed: 1450 rpm

Open Impeller

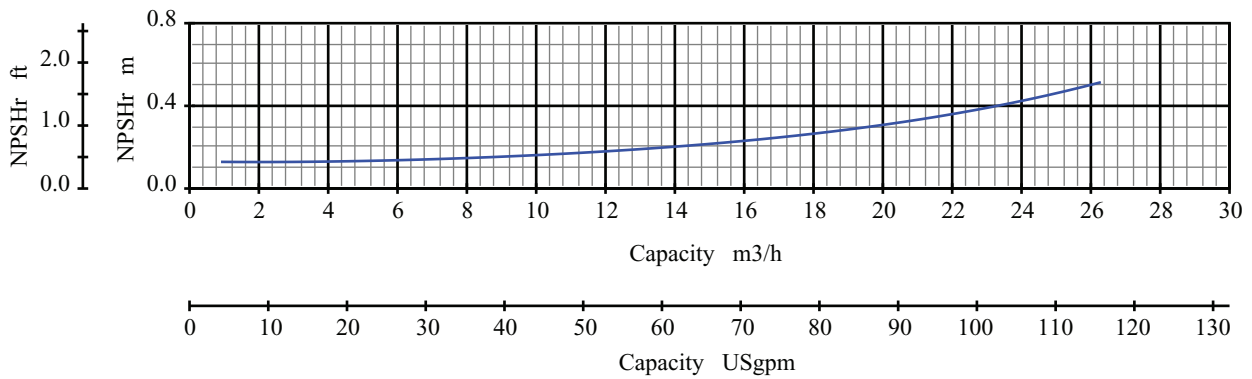
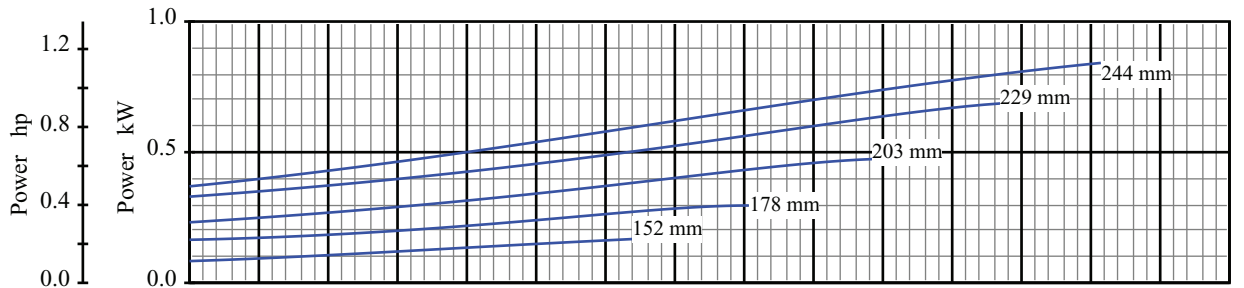
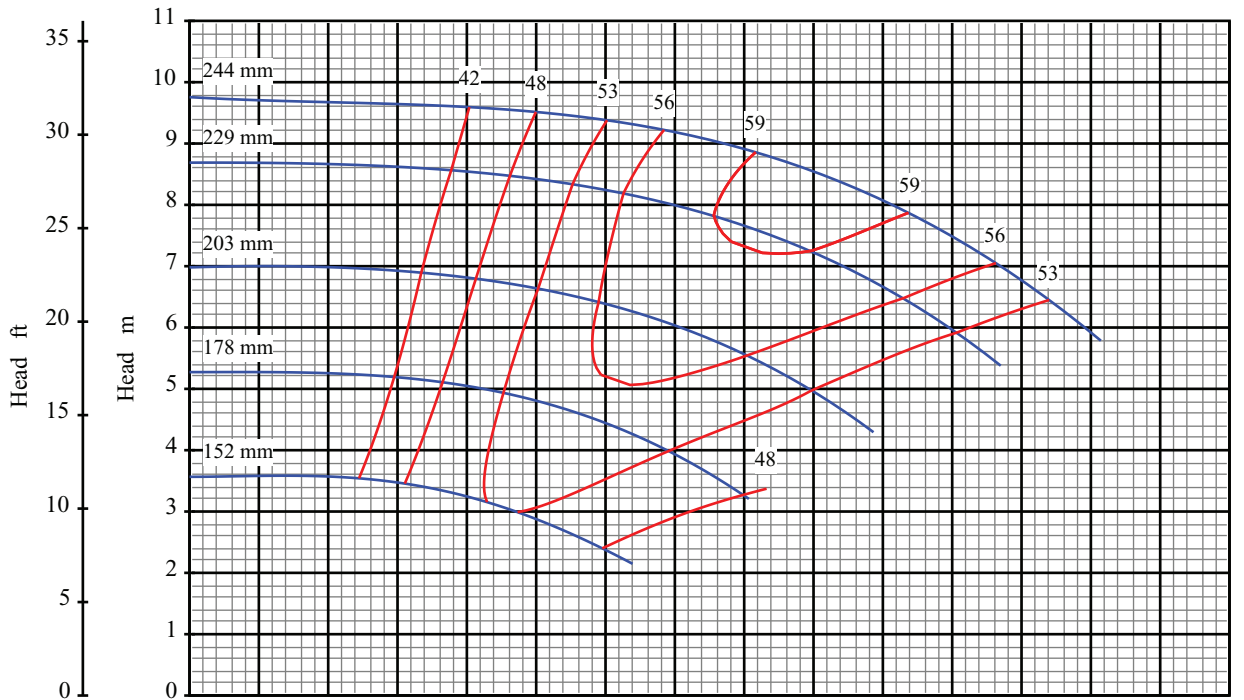

Curve No: S18165V1

Effective Date: Jan/2005

Blackmer Centrifugal

Pump Performance Characteristics

Catalog: 1301

Pump Size: 40x80 250

Pump Size: 1.5x3 10

Speed: 960 rpm

Open Impeller

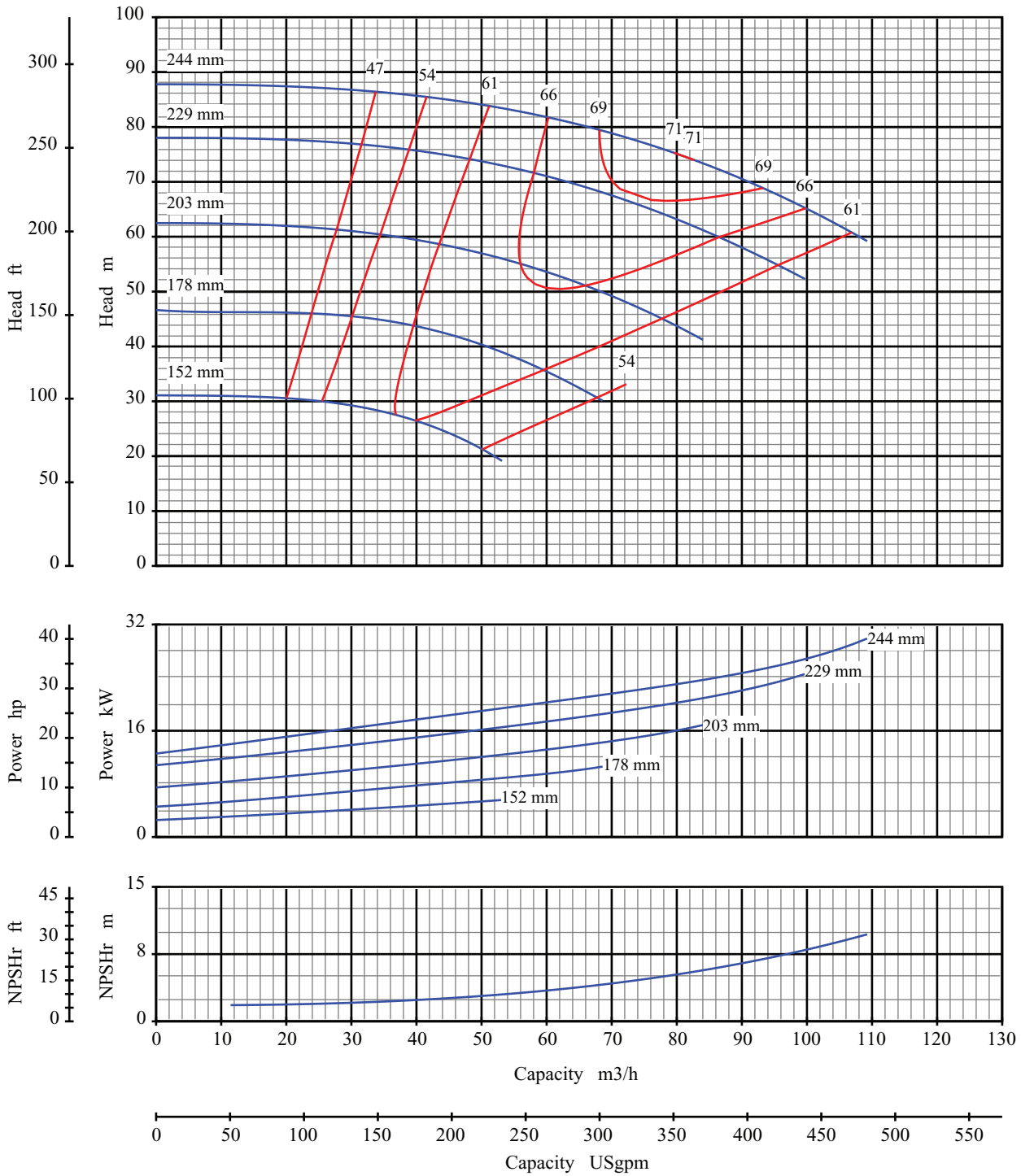

Curve No: S18167V1

Blackmer Centrifugal

Pump Performance Characteristics

Effective Date: Jan/2005

Catalog: 1301

Pump Size: 50x80 250

Pump Size: 2x3 10

Speed: 2900 rpm

Open Impeller

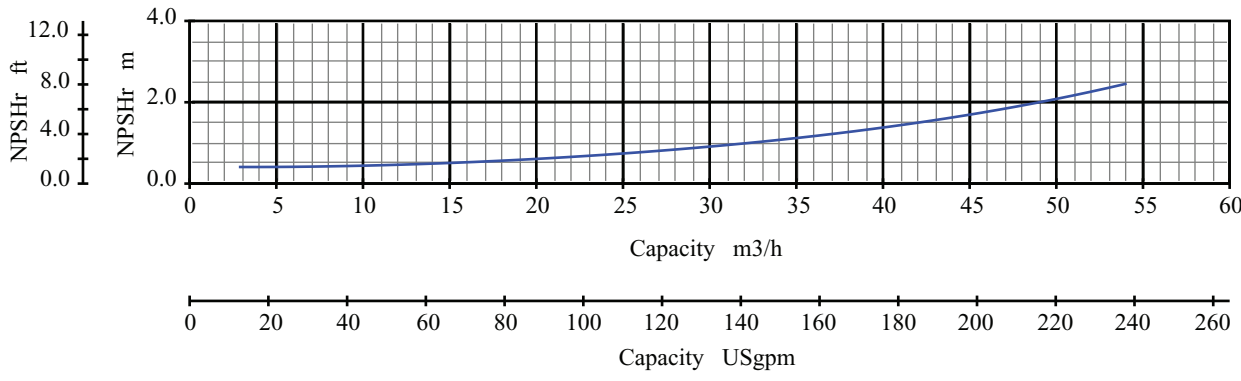
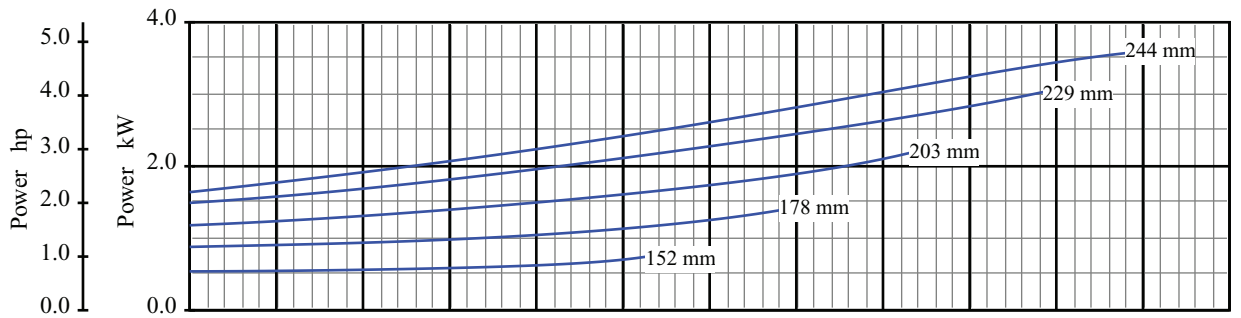
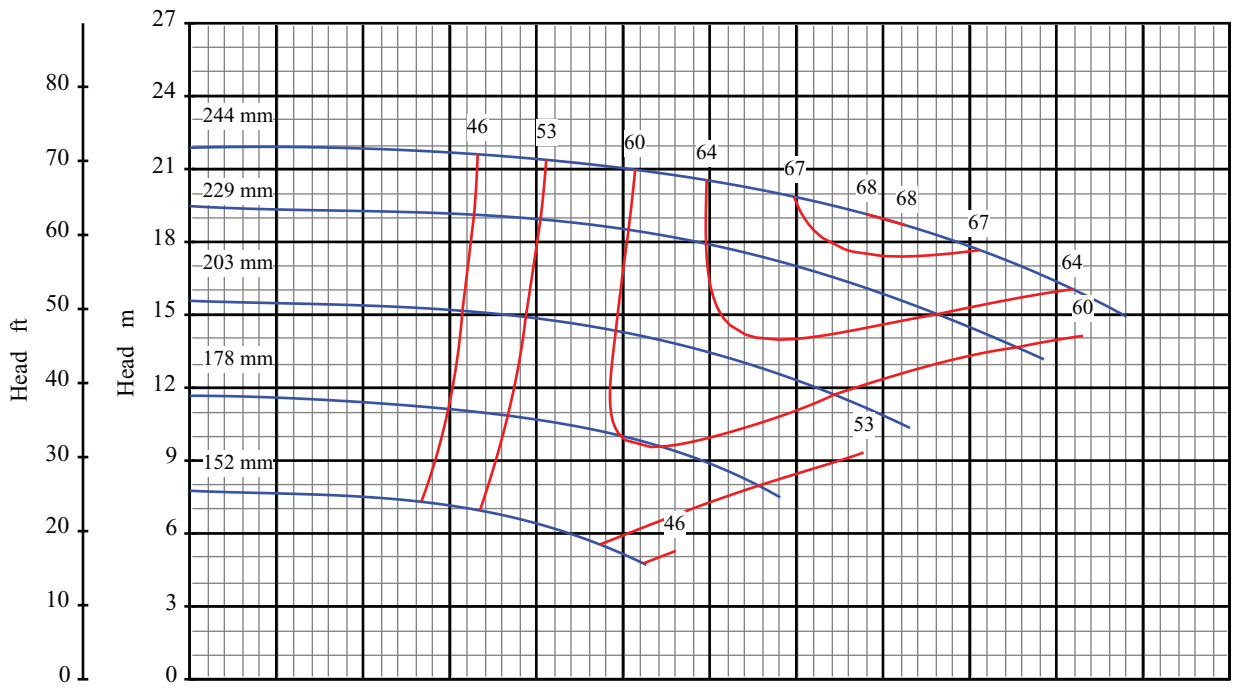

Curve No: S18169V1

Blackmer Centrifugal

Pump Size: 50x80 250

Pump Performance Characteristics

Pump Size: 2x3 10

Effective Date: Jan/2005

Catalog: 1301

Speed: 1450 rpm

Open Impeller

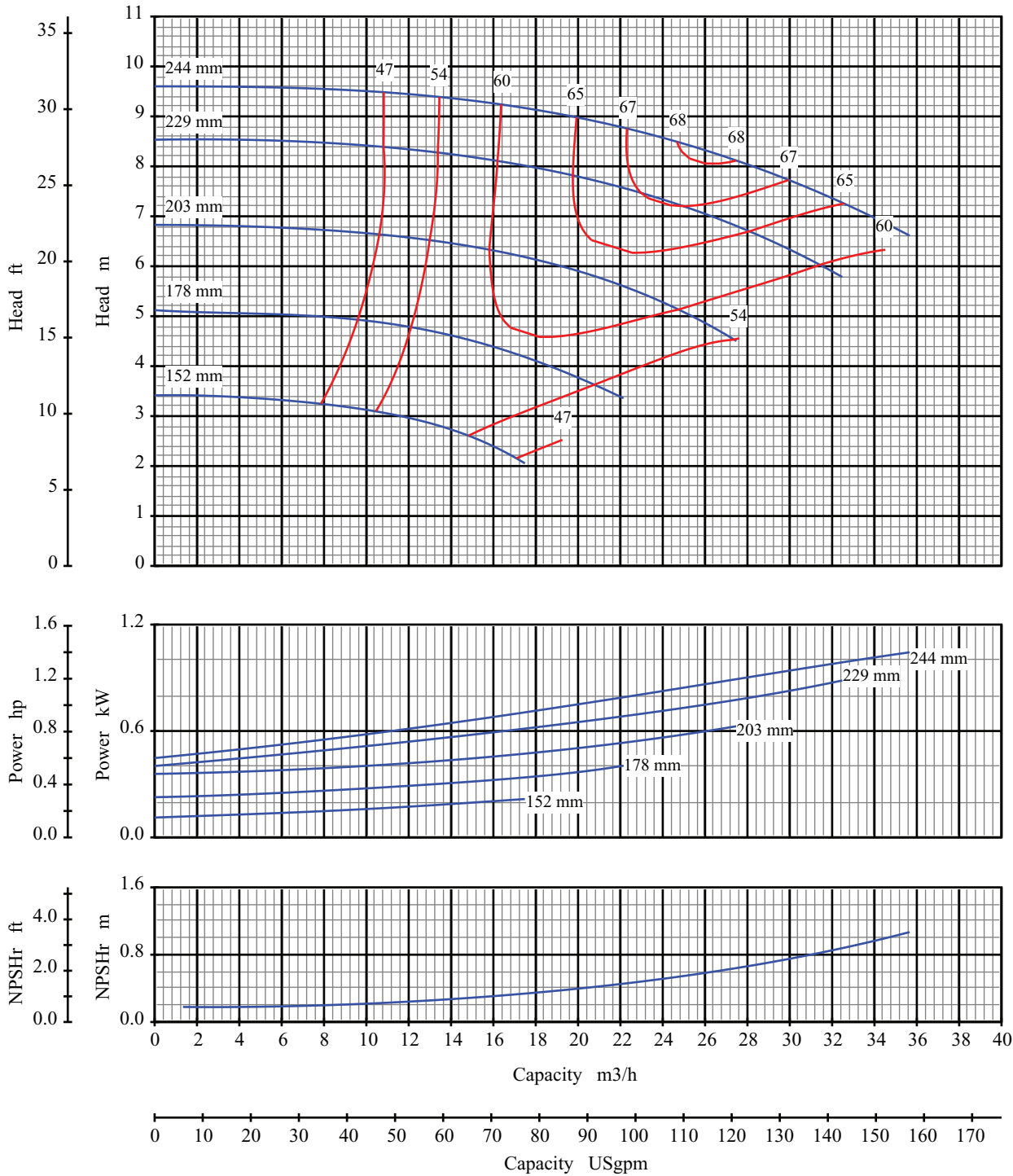

Curve No: S18171V1

Blackmer Centrifugal

Pump Size: 50x80 250

Pump Performance Characteristics

Pump Size: 2x3 10

Effective Date: Jan/2005

Catalog: 1301

Speed: 960 rpm

Open Impeller

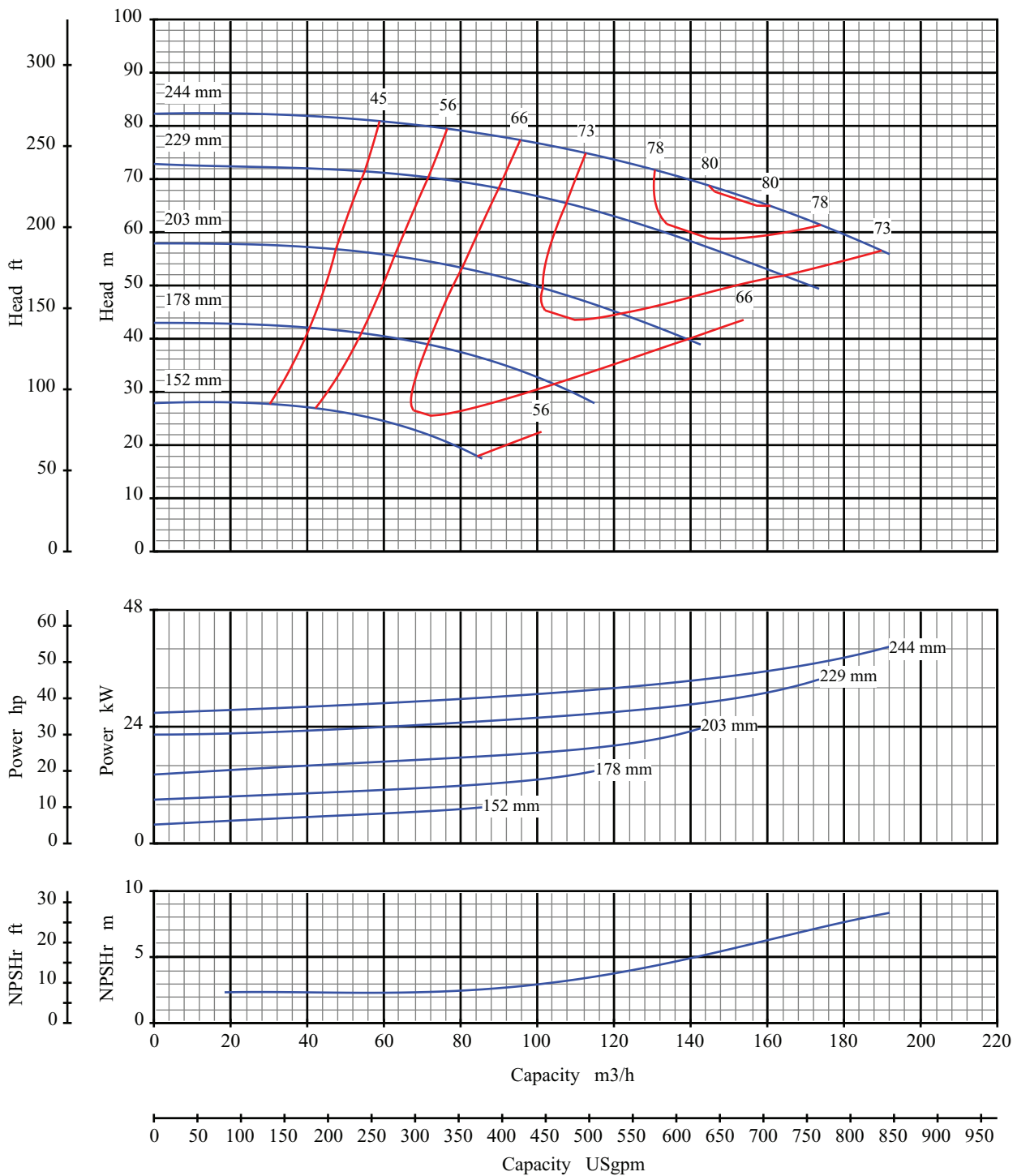

Curve No: S18173V1

Effective Date: Jan/2005

Blackmer Centrifugal

Pump Performance Characteristics

Catalog: 1301

Pump Size: 80x100 250

Pump Size: 3x4 10

Speed: 2900 rpm

Open Impeller

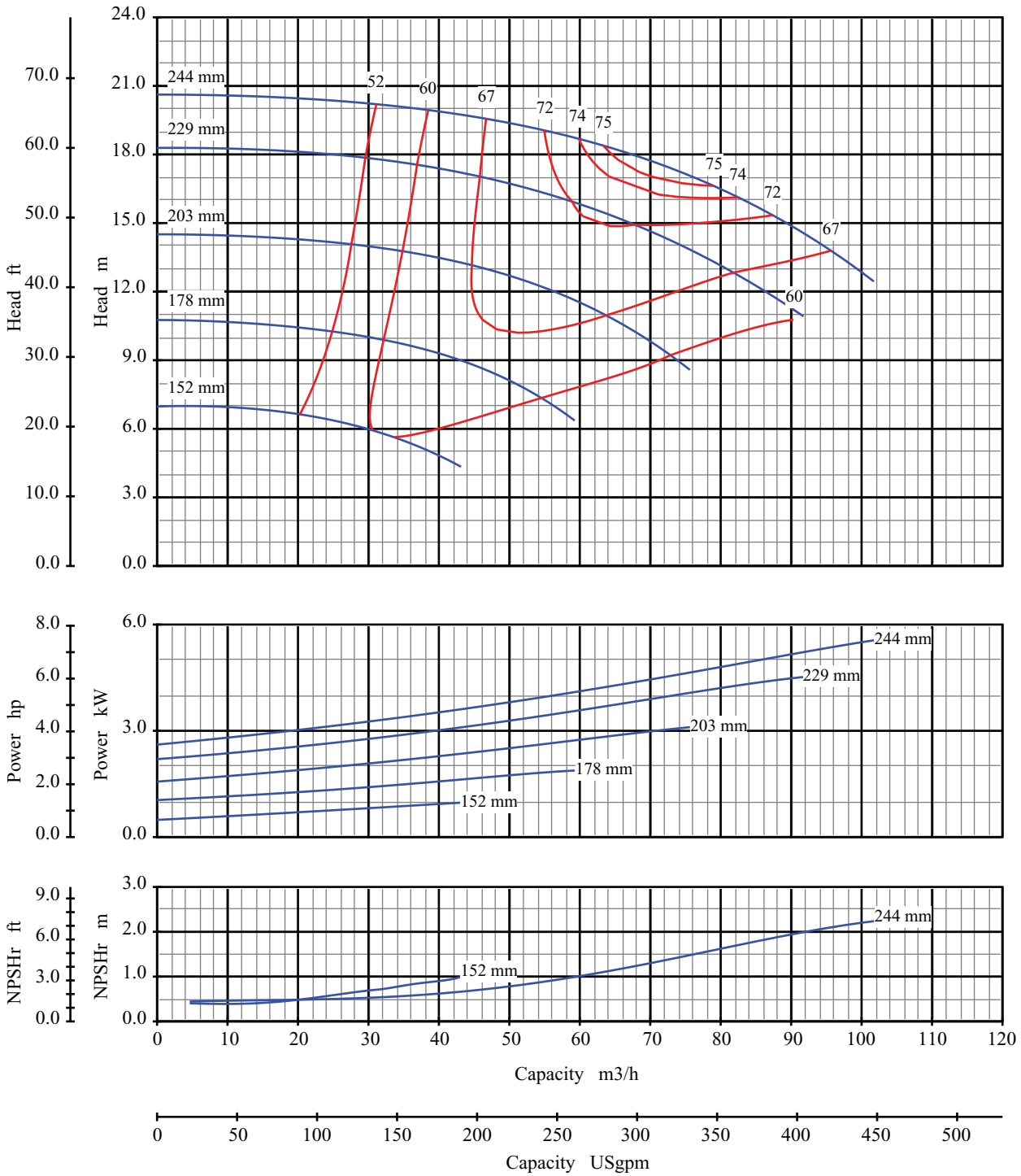

Curve No: S18175V1

Blackmer Centrifugal

Pump Performance Characteristics

Effective Date: Jan/2005

Catalog: 1301

Pump Size: 80x100 250

Pump Size: 3x4 10

Speed: 1450 rpm

Open Impeller

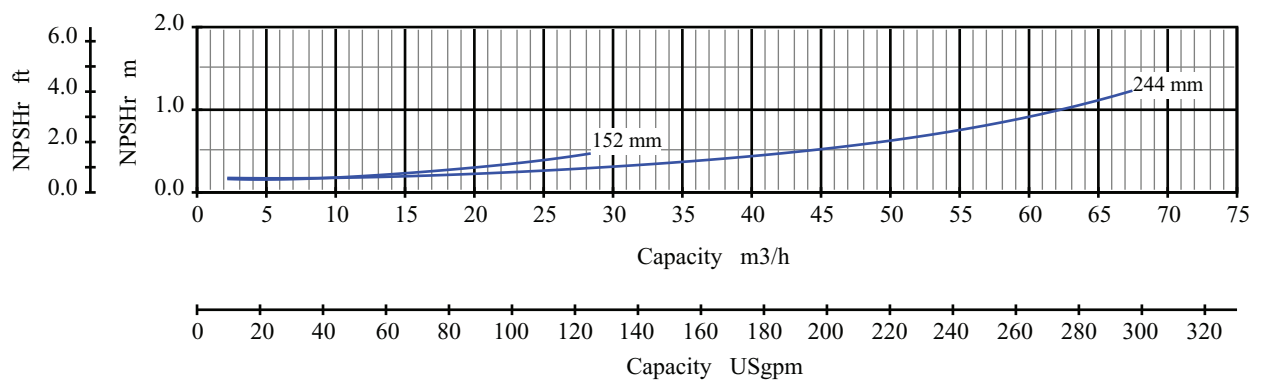
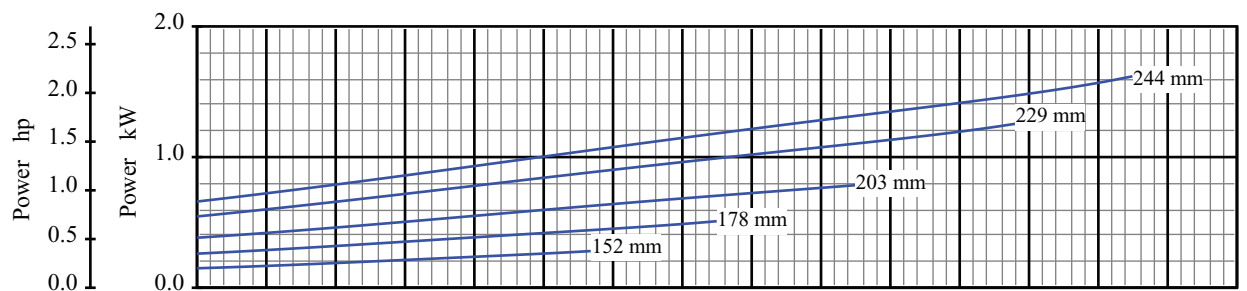
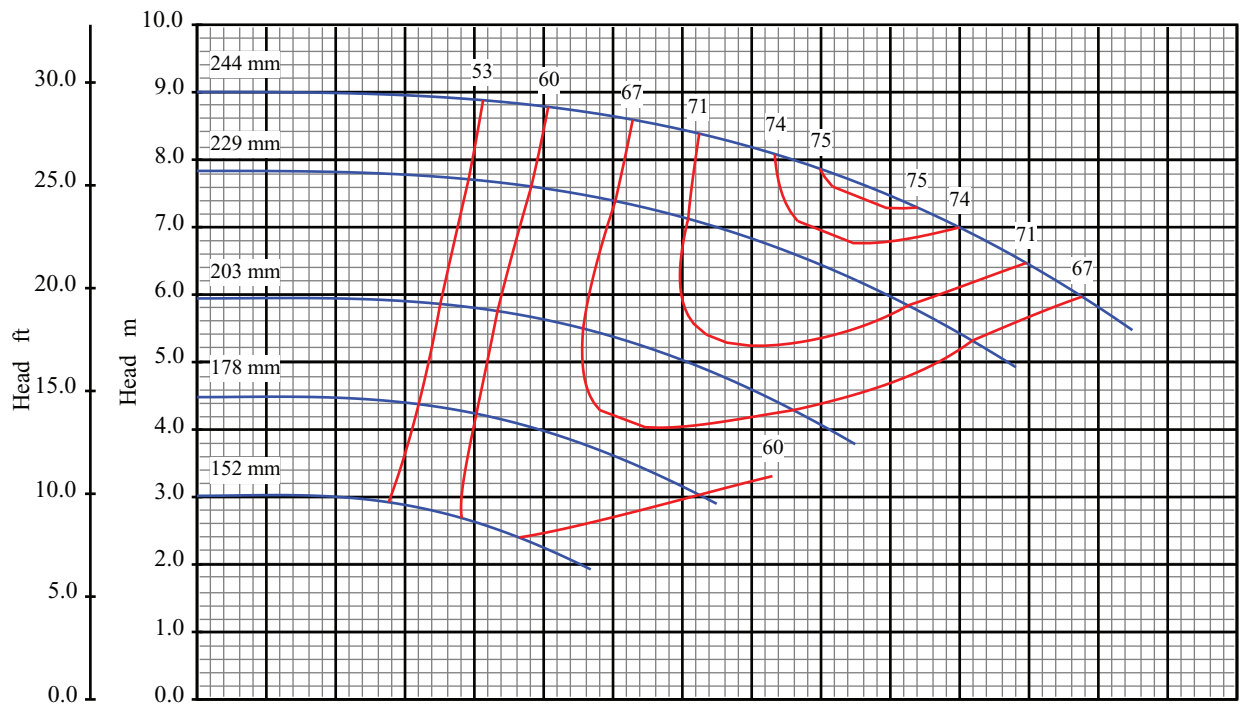

Curve No: S18177V1

Effective Date: Jan/2005

Blackmer Centrifugal

Pump Performance Characteristics

Catalog: 1301

Pump Size: 80x100 250

Pump Size: 3x4 10

Speed: 960 rpm

Open Impeller

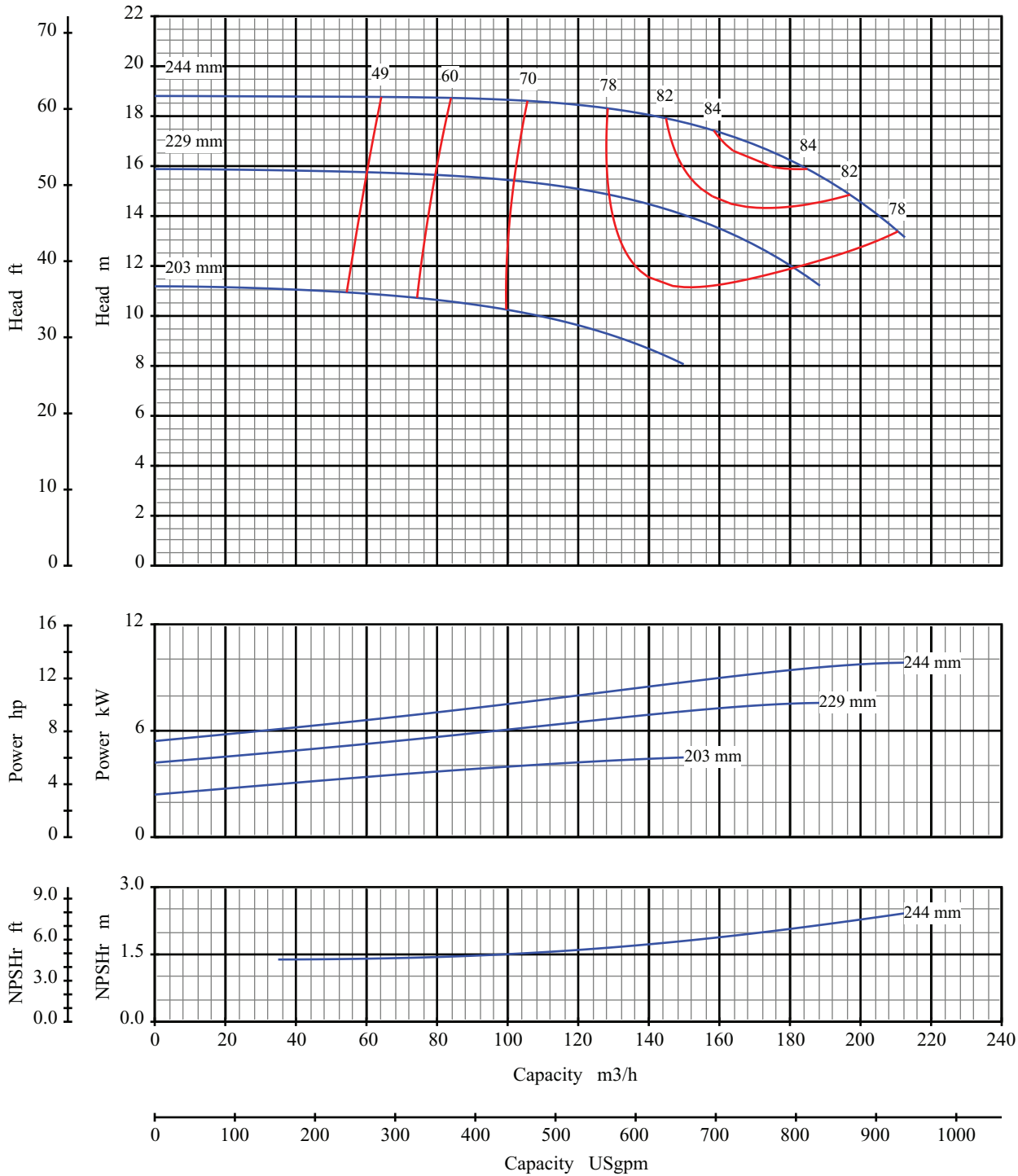

Curve No: S18181V1

Blackmer Centrifugal

Pump Size: 100x150 250

Pump Performance Characteristics

Pump Size: 4x6 10

Effective Date: Jan/2005

Catalog: 1301

Speed: 1450 rpm

Open Impeller

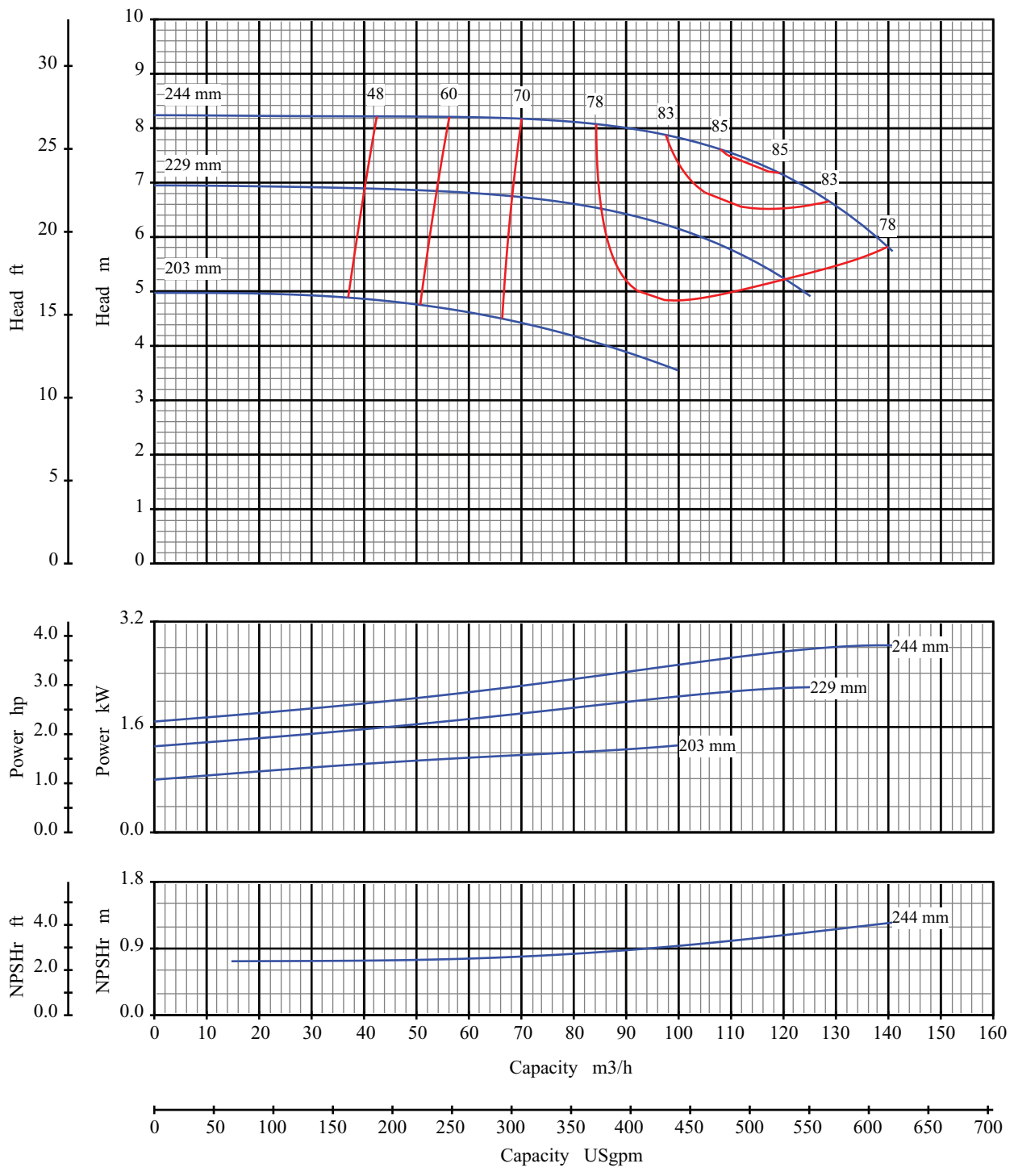

Curve No: S18183V1

Blackmer Centrifugal

Pump Size: 100x150 250

Pump Performance Characteristics

Pump Size: 4x6 10

Effective Date: Jan/2005

Catalog: 1301

Speed: 960 rpm

Open Impeller

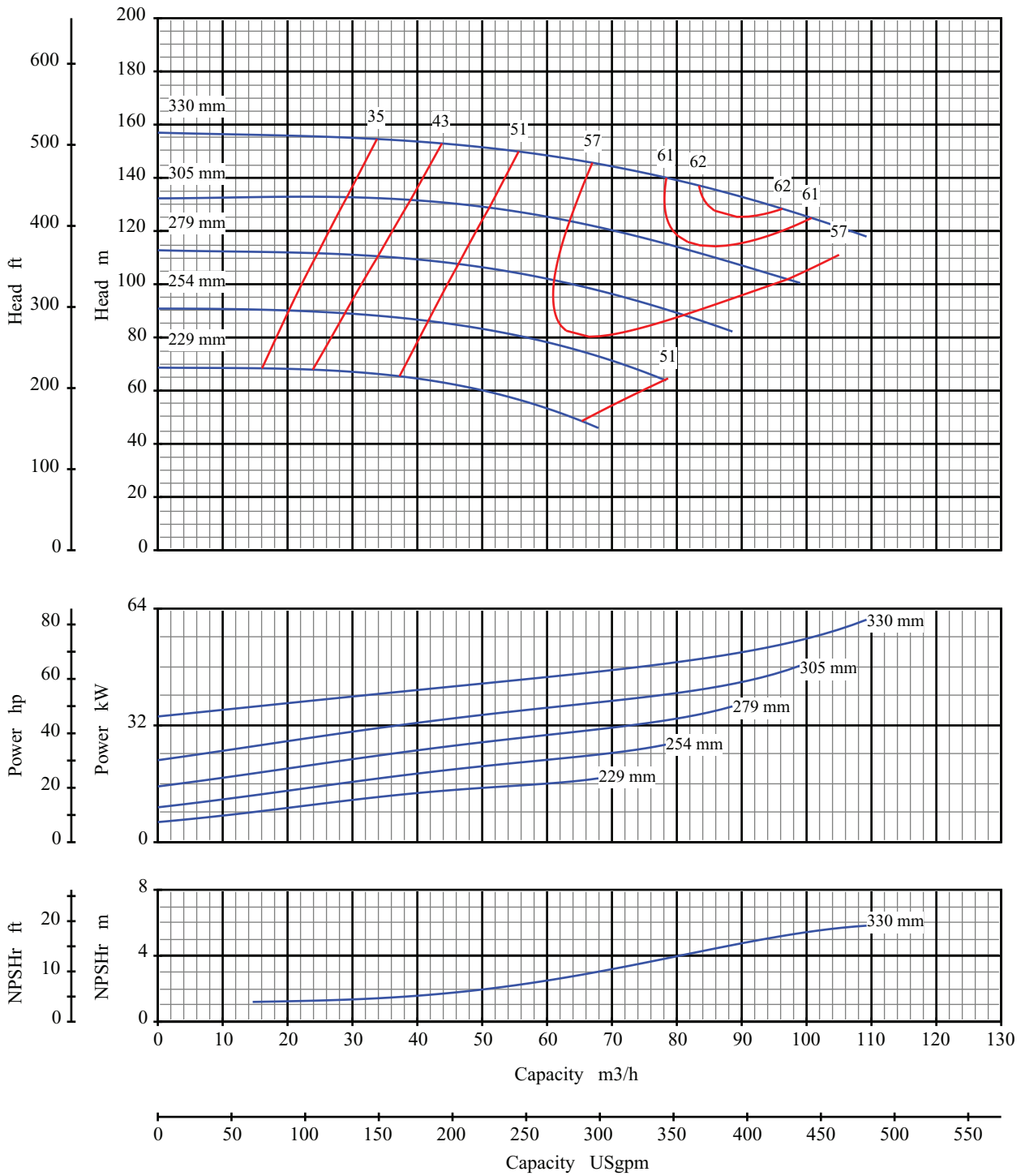

Curve No: S18185V1

Blackmer Centrifugal

Pump Size: 40x80 330

Pump Performance Characteristics

Pump Size: 1.5x3 13

Effective Date: Jan/2005

Catalog: 1301

Speed: 2900 rpm

Open Impeller

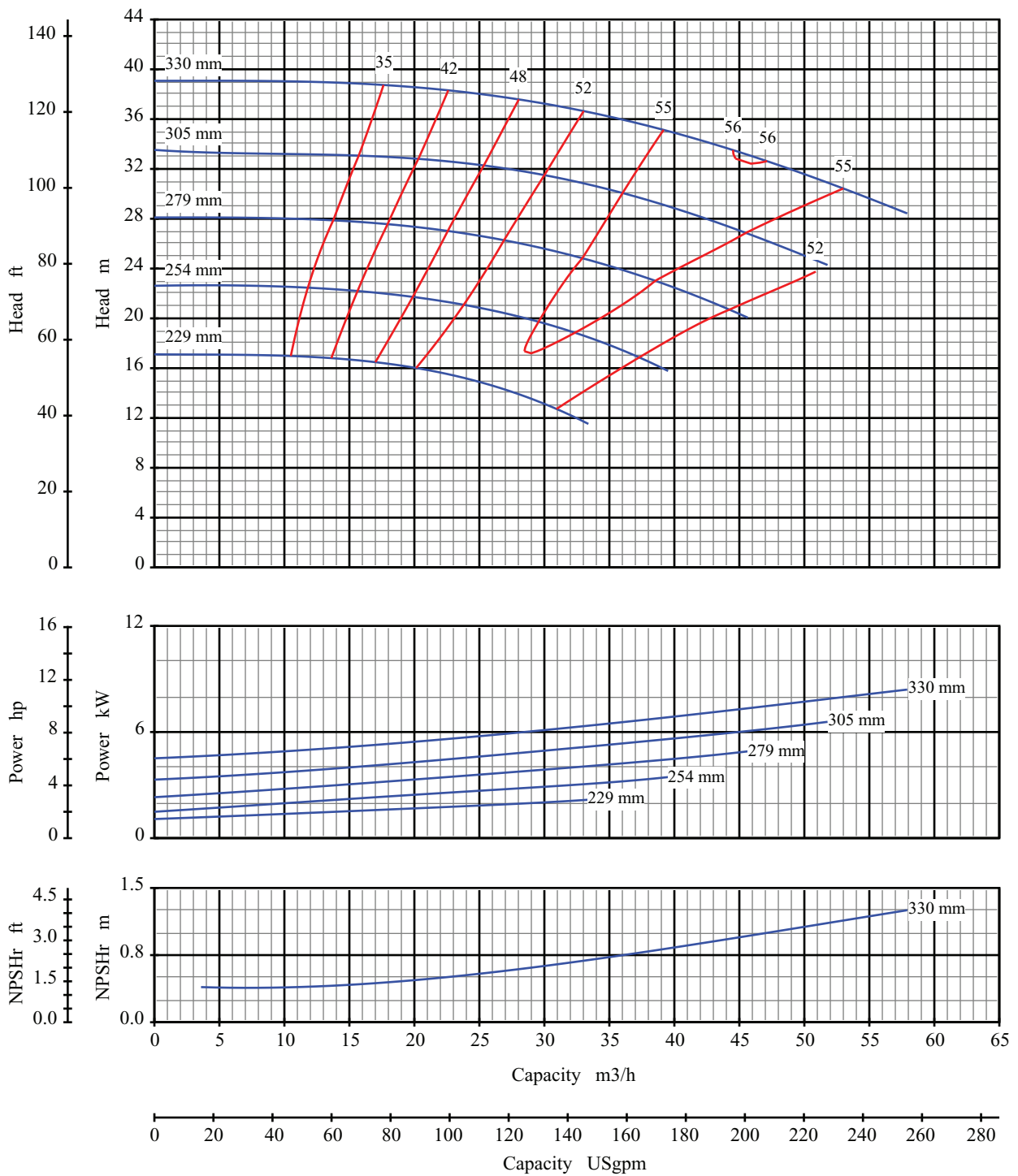

Curve No: S18187V1

Effective Date: Jan/2005

Blackmer Centrifugal

Pump Performance Characteristics

Catalog: 1301

Pump Size: 40x80 330

Pump Size: 1.5x3 13

Speed: 1450 rpm

Open Impeller

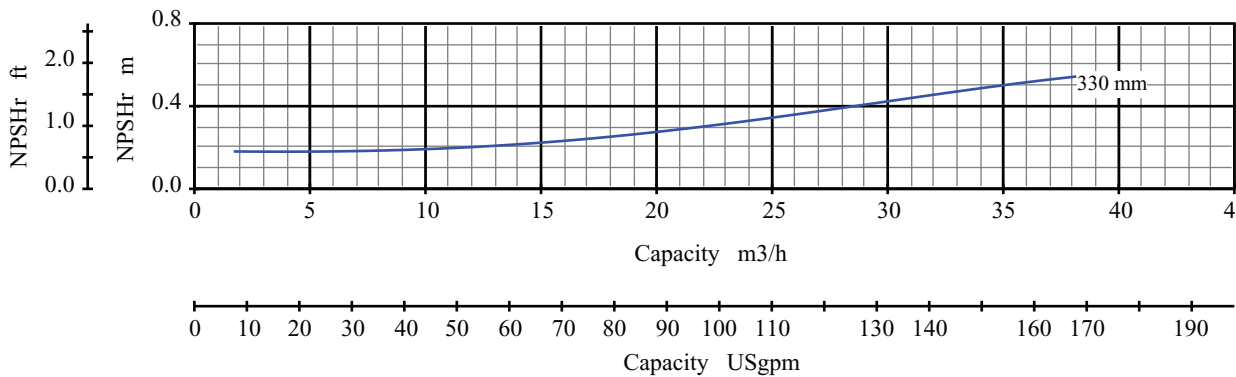
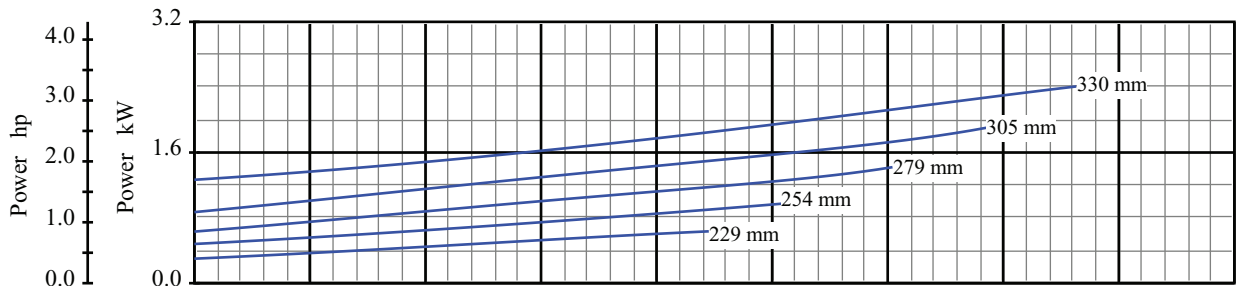
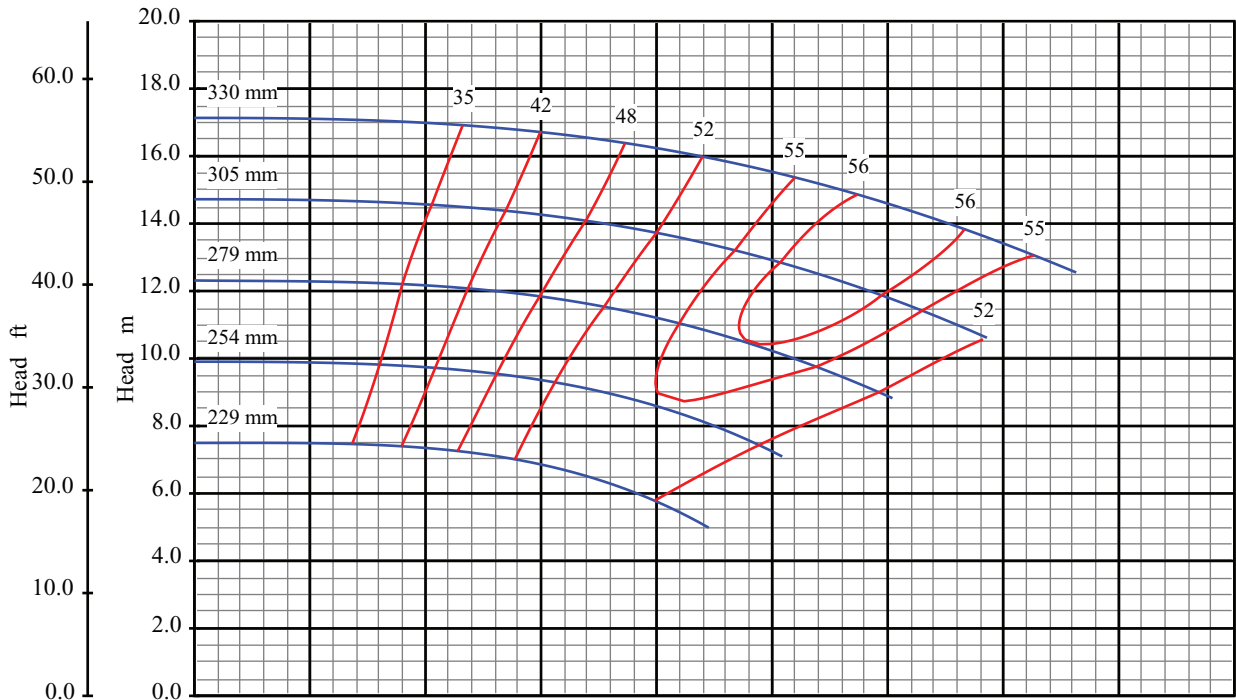

Curve No: S18189V1

Blackmer Centrifugal

Pump Performance Characteristics

Effective Date: Jan/2005

Catalog: 1301

Pump Size: 40x80 330

Pump Size: 1.5x3 13

Speed: 960 rpm

Open Impeller

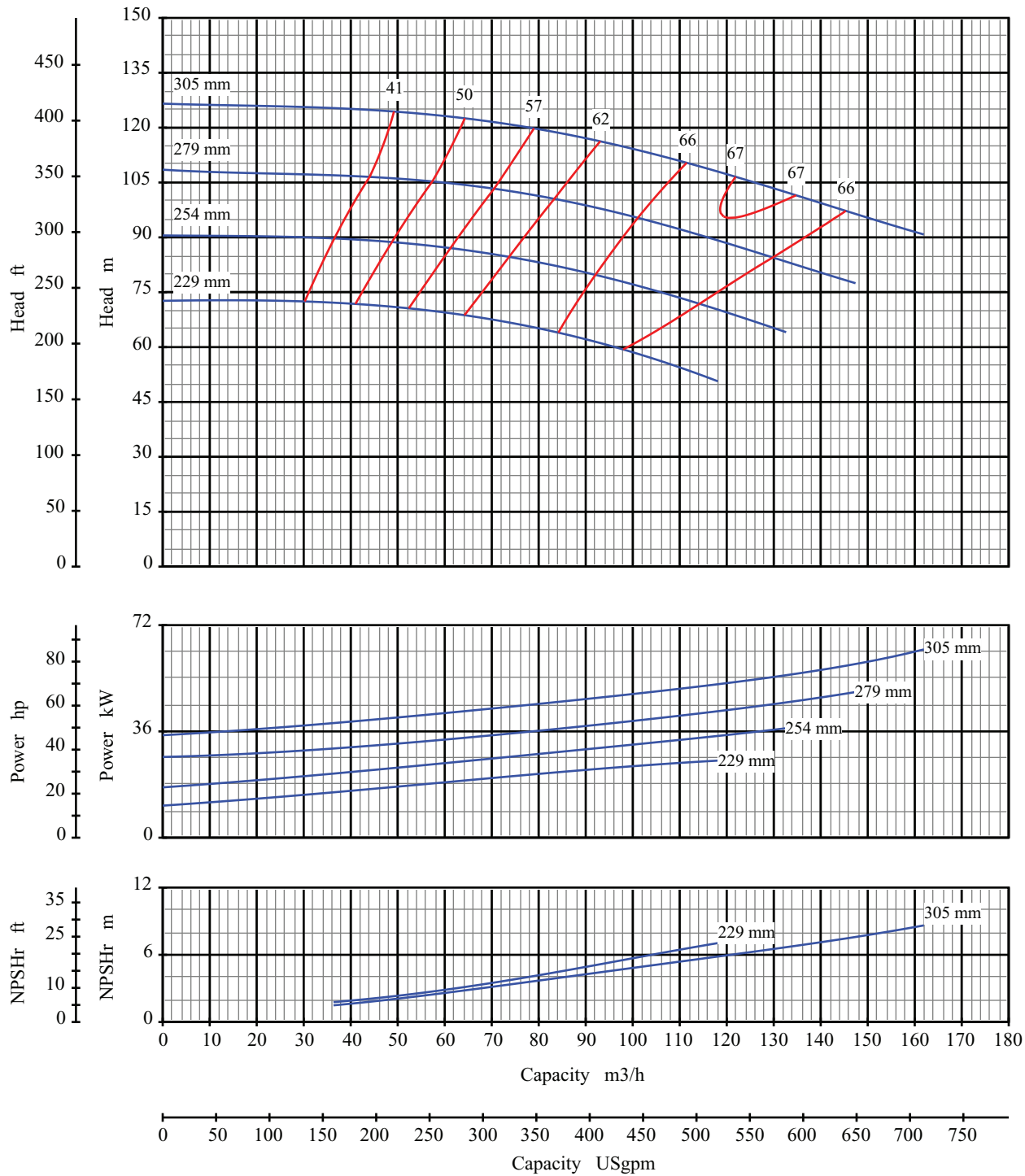

Curve No: S18191V1

Blackmer Centrifugal

Pump Performance Characteristics

Catalog: 1301

Effective Date: Jan/2005

Pump Size: 50x80 330

Pump Size: 2x3 13

Speed: 2900 rpm

Open Impeller

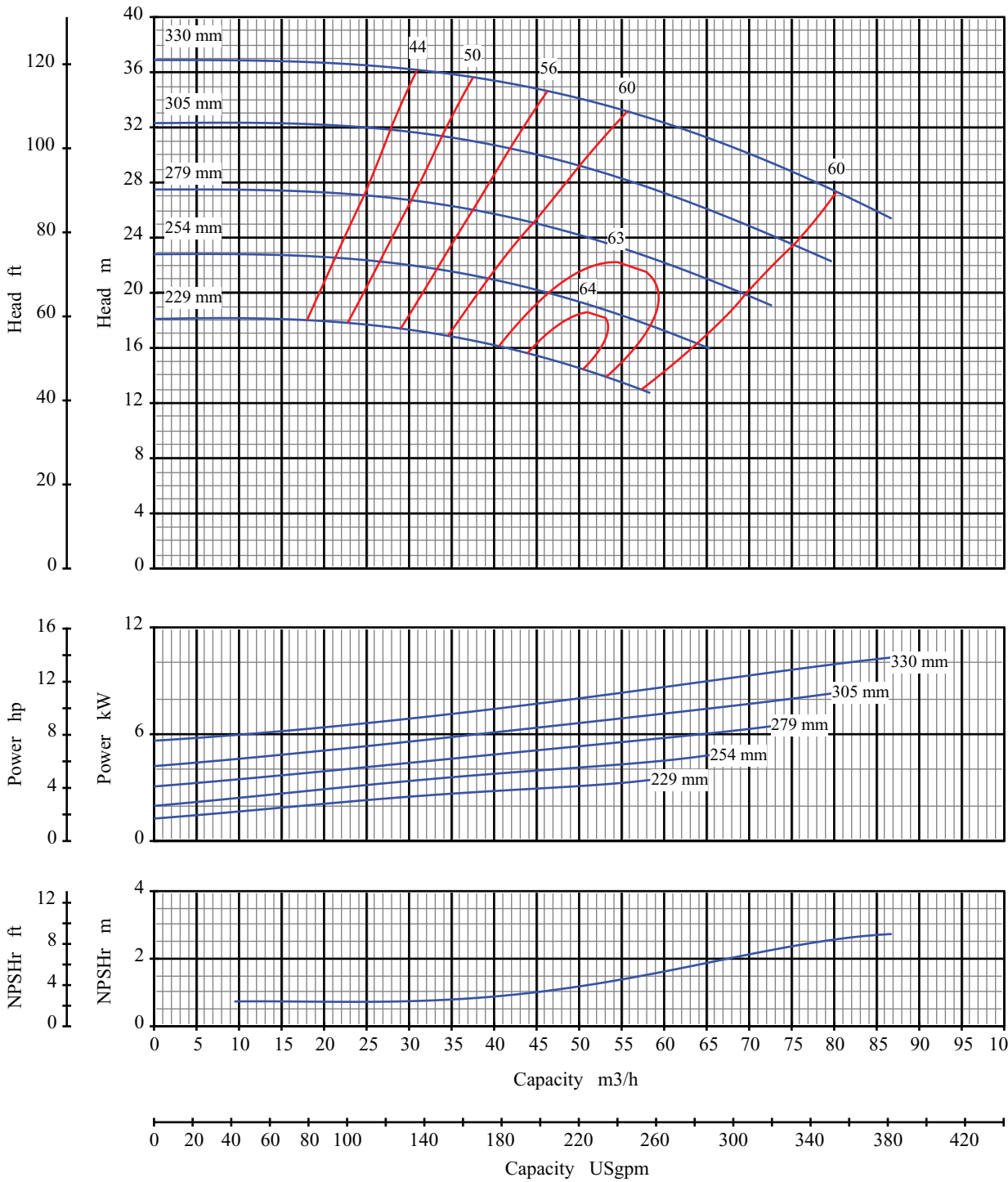

Curve No: S18193V1

Blackmer Centrifugal

Pump Size: 50x80 330

Pump Performance Characteristics

Pump Size: 2x3 13

Effective Date: Jan/2005

Catalog: 1301

Speed: 1450 rpm

Open Impeller

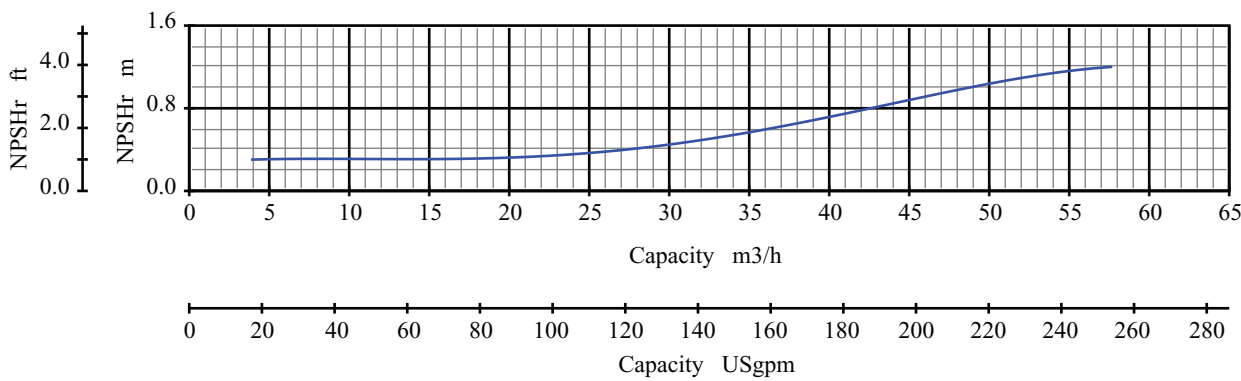
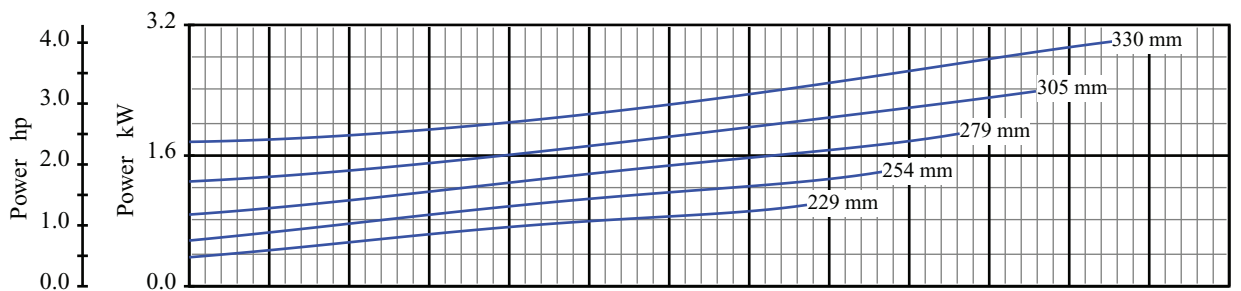
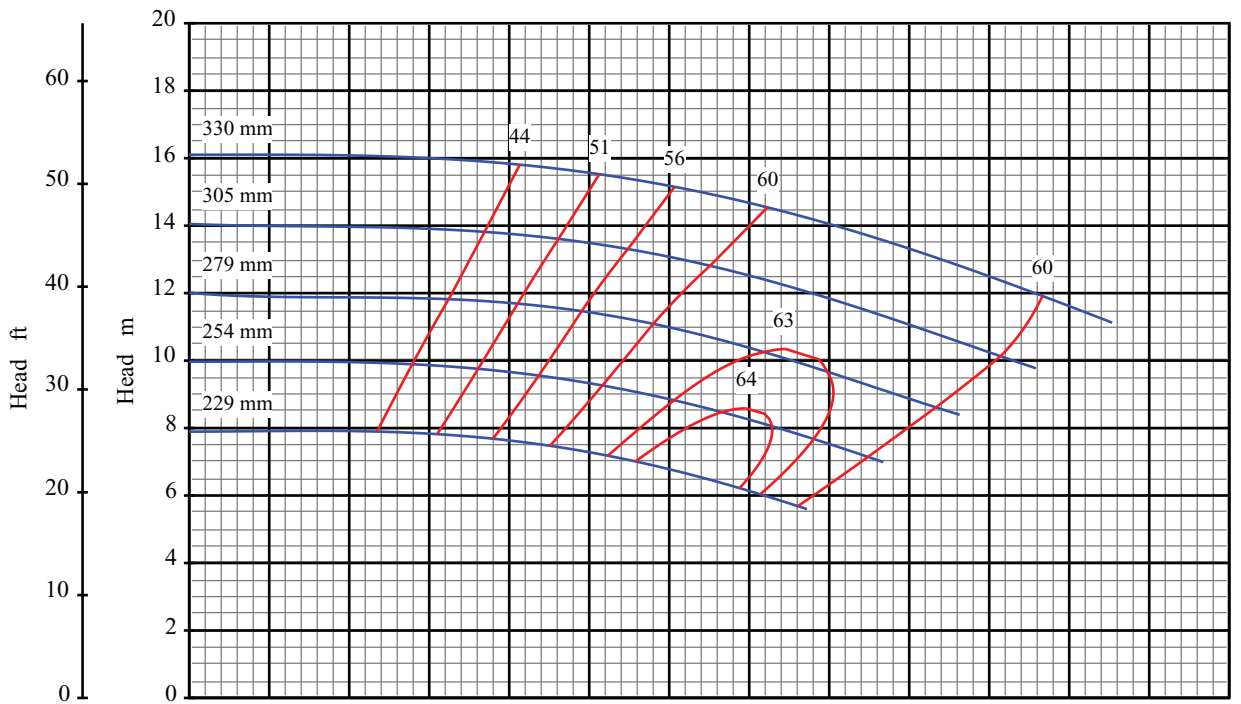

Curve No: S18195V1
 Effective Date: Jan/2005

Blackmer Centrifugal

Pump Performance Characteristics
 Catalog: 1301

Pump Size: 50x80 330
 Pump Size: 2x3 13
 Speed: 960 rpm
 Open Impeller

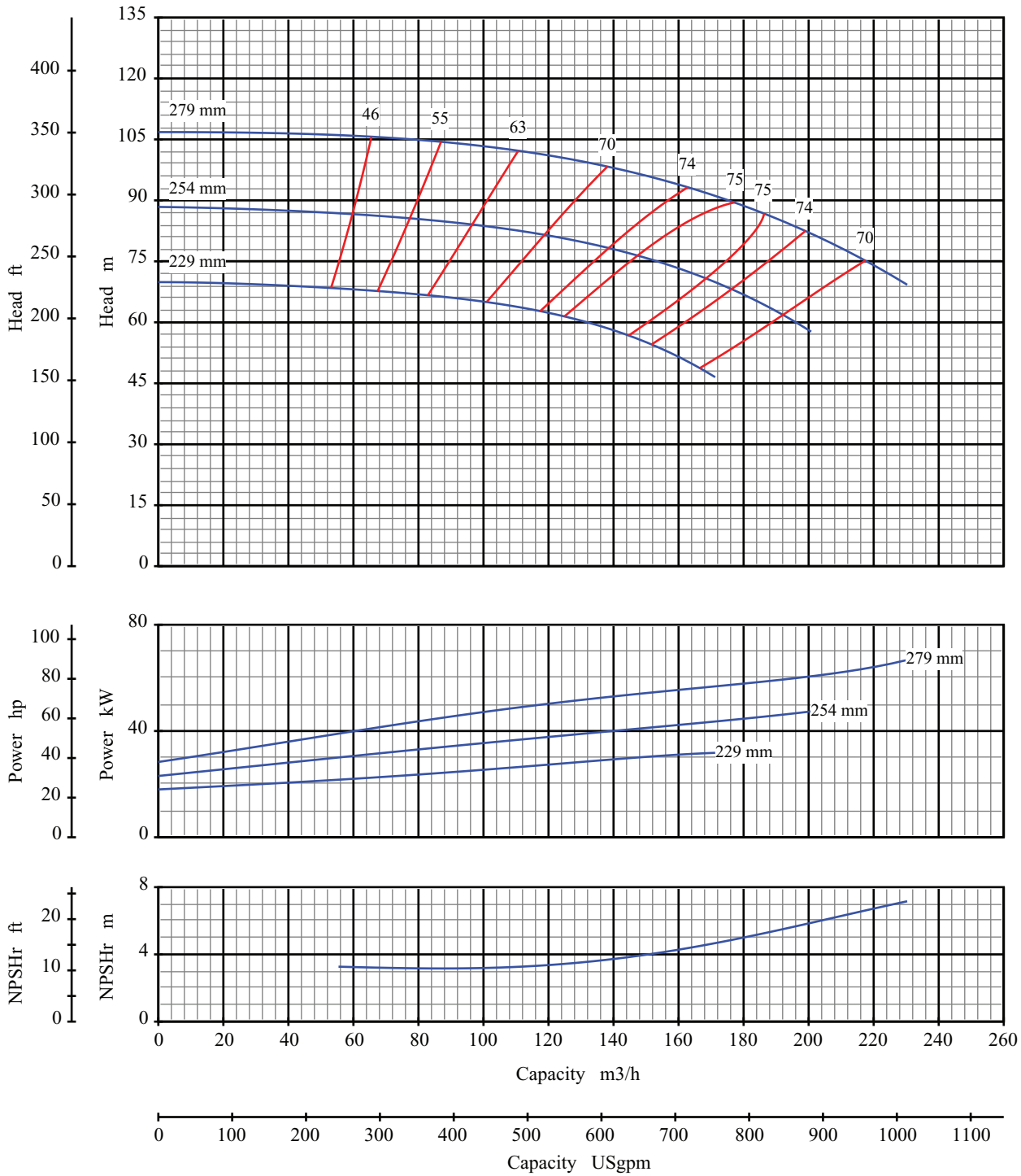

Curve No: S18197V1

Blackmer Centrifugal

Pump Size: 50x80 330

Pump Performance Characteristics

Pump Size: 2x3 13

Effective Date: Jan/2005

Catalog: 1301

Speed: 2900 rpm

Open Impeller

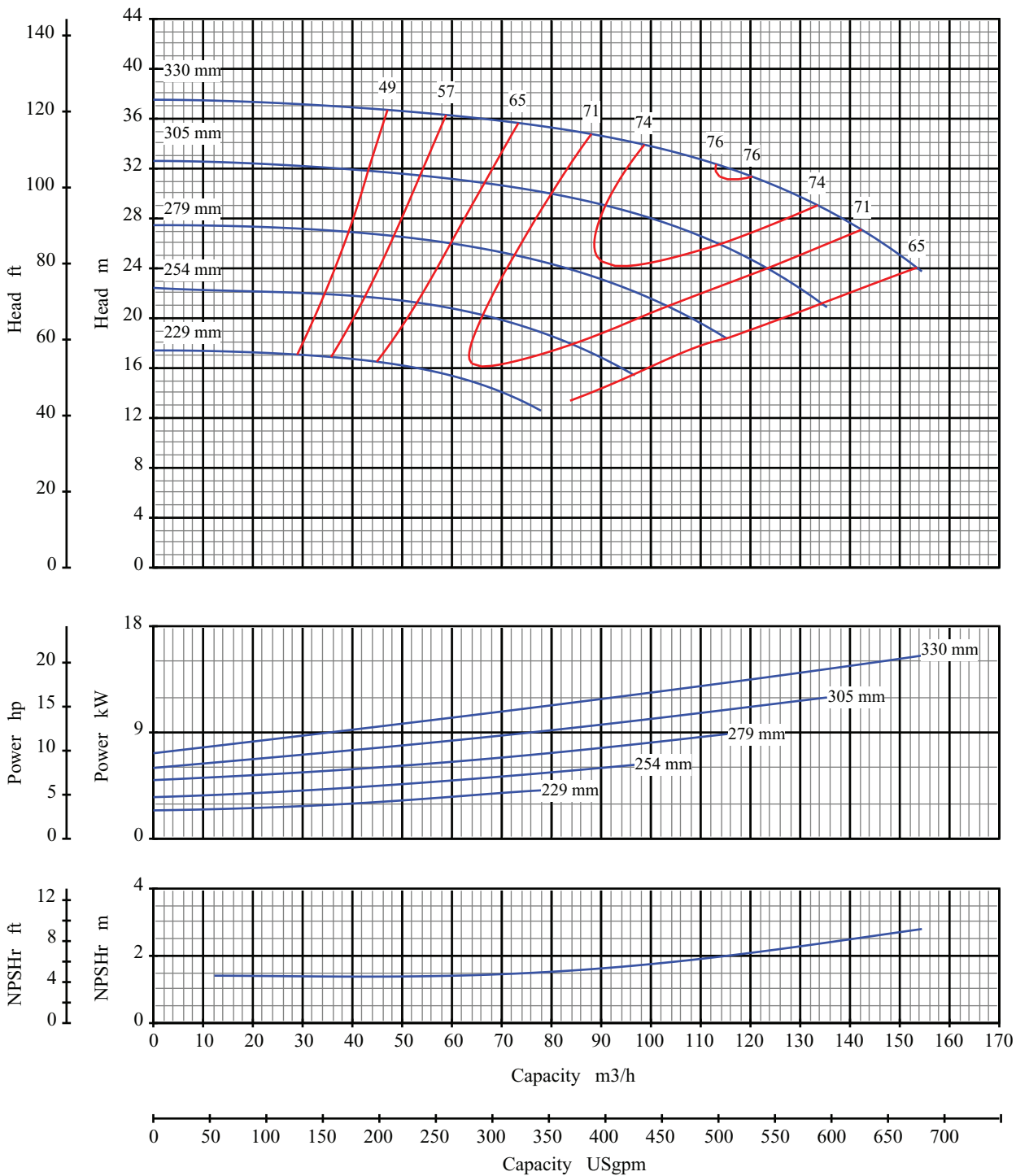

Curve No: S18199V1

Blackmer Centrifugal

Pump Size: 80x100 330

Pump Performance Characteristics

Pump Size: 3x4 13

Effective Date: Jan/2005

Catalog: 1301

Speed: 1450 rpm

Open Impeller

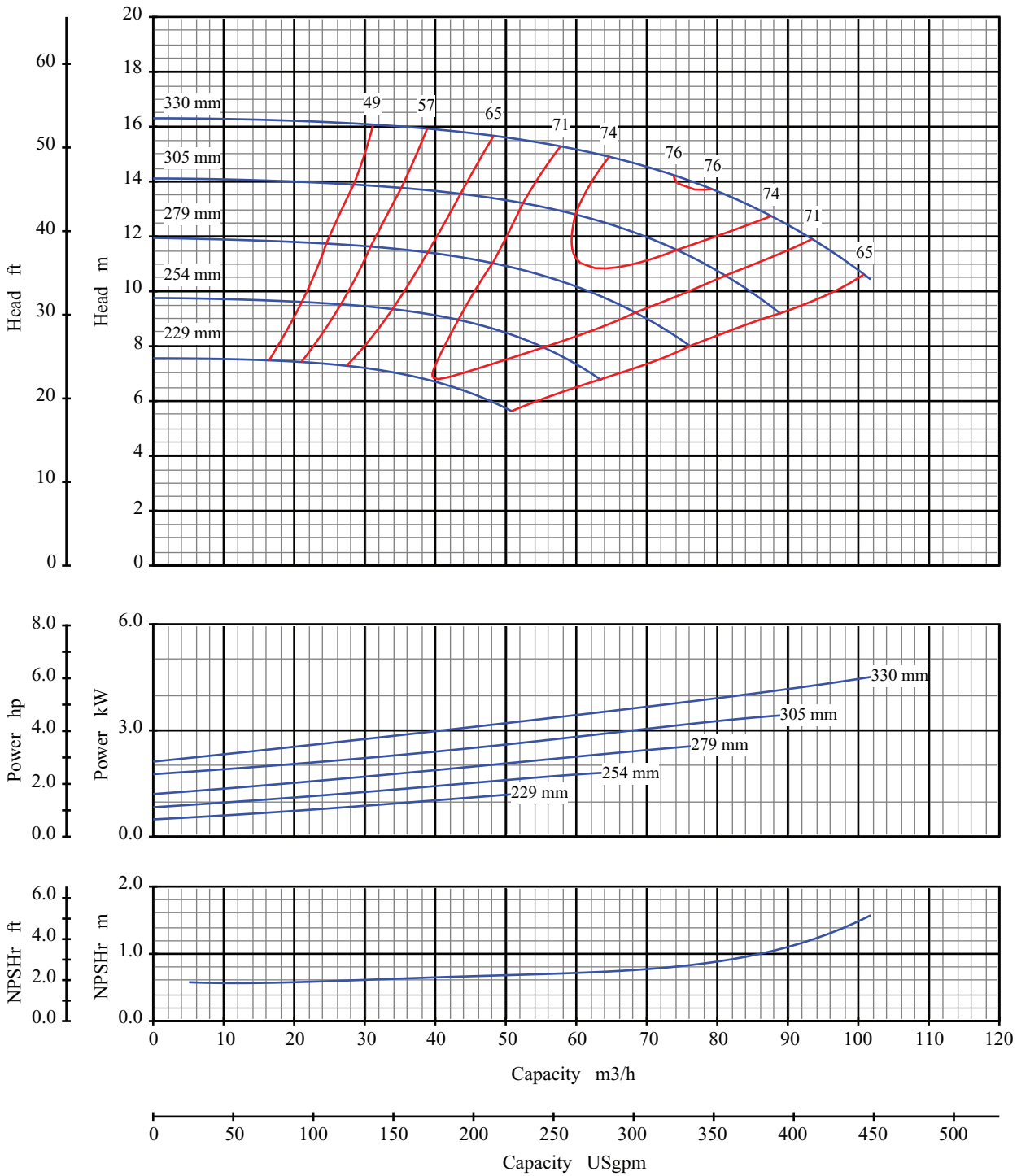

Curve No: S18201V1

Blackmer Centrifugal

Pump Performance Characteristics

Effective Date: Jan/2005

Catalog: 1301

Pump Size: 80x100 330

Pump Size: 3x4 13

Speed: 960 rpm

Open Impeller

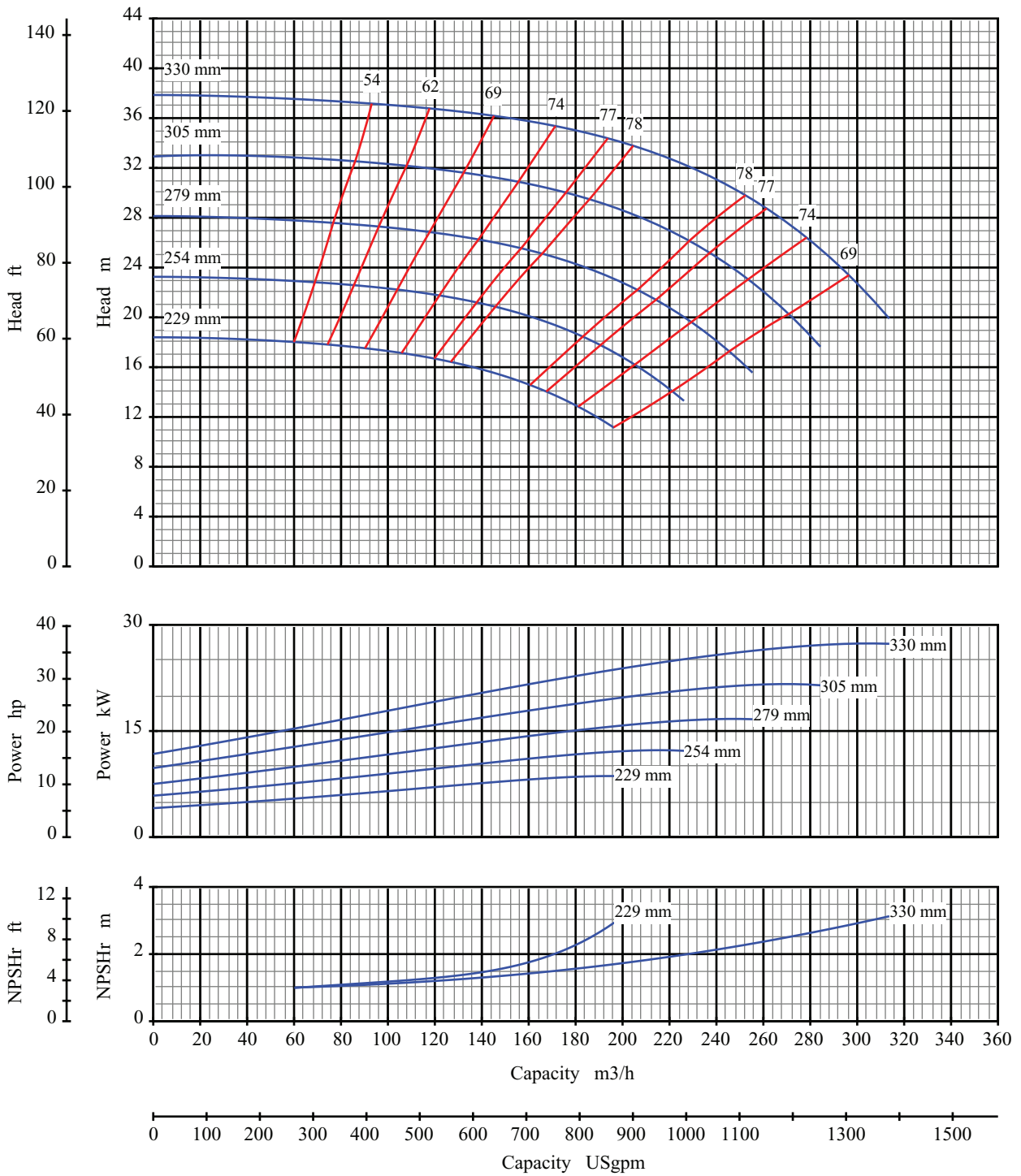

Curve No: S18205V1

Blackmer Centrifugal

Pump Performance Characteristics

Effective Date: Jan/2005

Catalog: 1301

Pump Size: 100 150 330

Pump Size: 4x6 13

Speed: 1450 rpm

Open Impeller

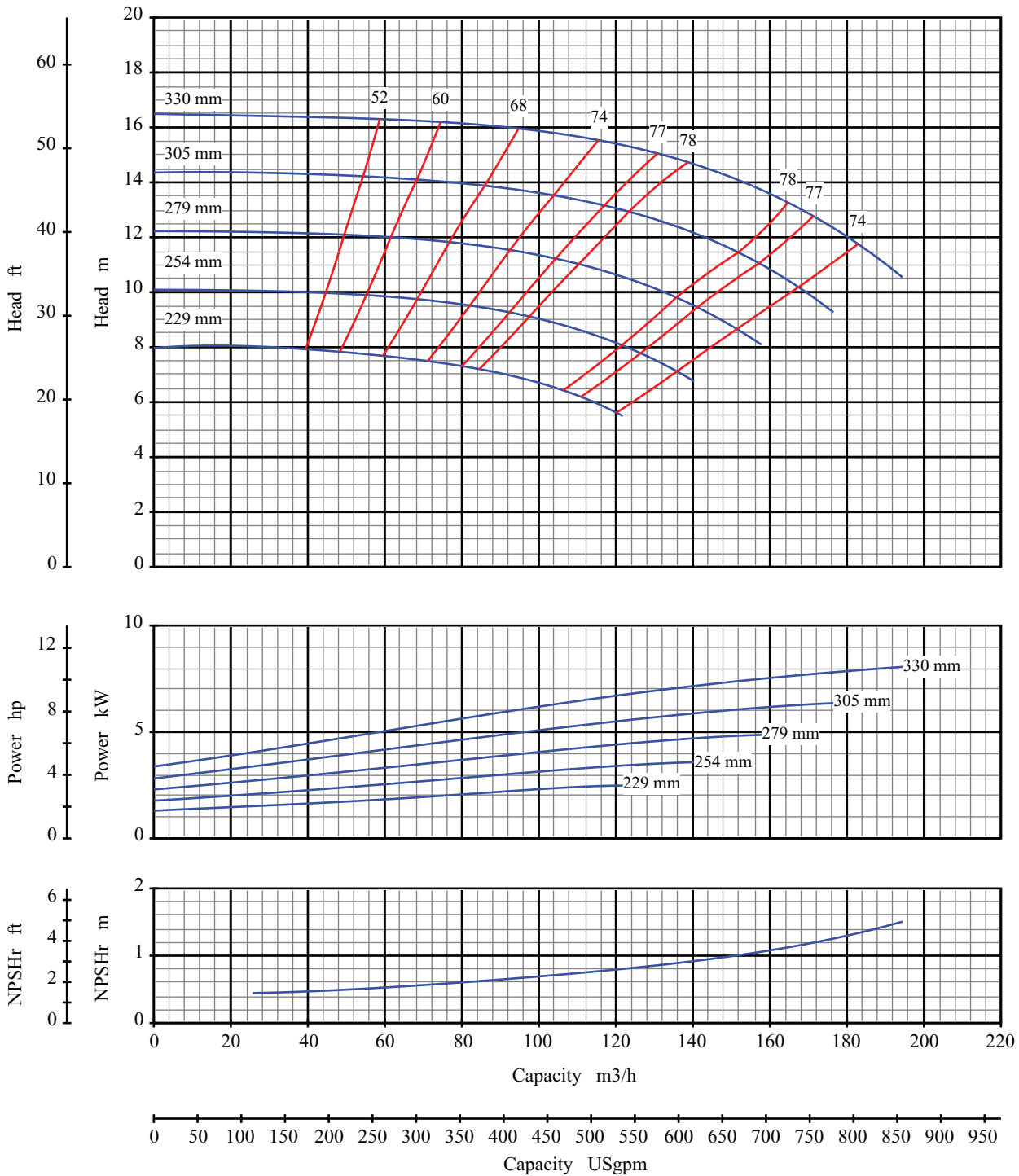

Curve No: S18207V1

Blackmer Centrifugal

Pump Performance Characteristics

Effective Date: Jan/2005

Catalog: 1301

Pump Size: 100 150 330

Pump Size: 4x6 13

Speed: 960 rpm

Open Impeller

Blackmer® Centrifugal Composite Pumps

Frame M Pump

- Large Frame Pump
- Lowest L3/D4 stiffness ratio of any pump in this size range at 19 (.87) Frame M
- Only AMSE/ANSI B73.1 pump of its size that offers centerline mount for high temperature applications
- Capacities up to 4,500 gpm
- Operating temperature range from -40° to 400°F (-40° to 204°C)
- Military shock standard S901 Grade A
- High Temperature Series configurations available with some Frame M sizes



Frame M (ASME/ANSI)

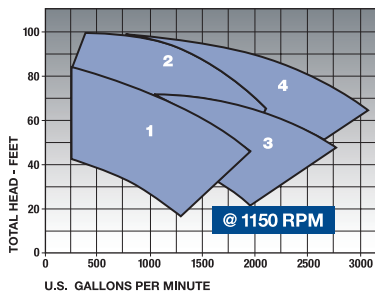
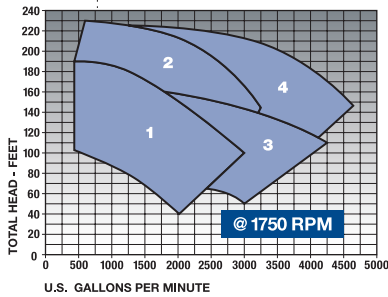
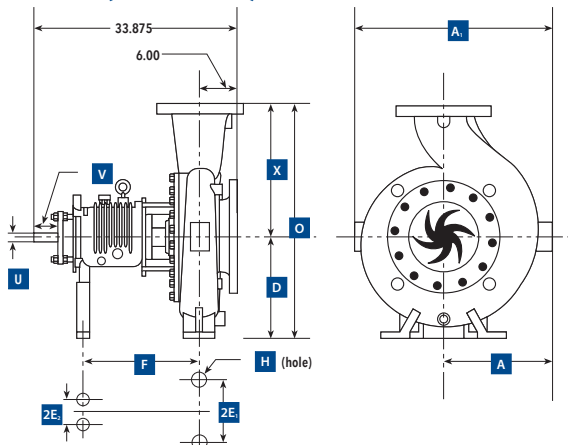

Frame M (Metric)

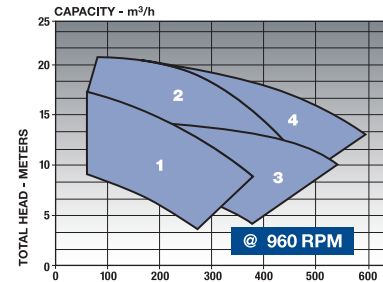
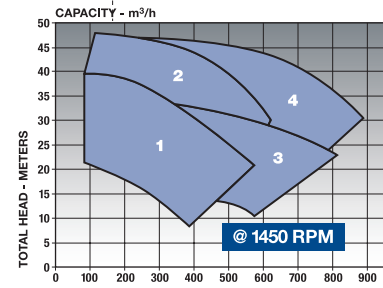
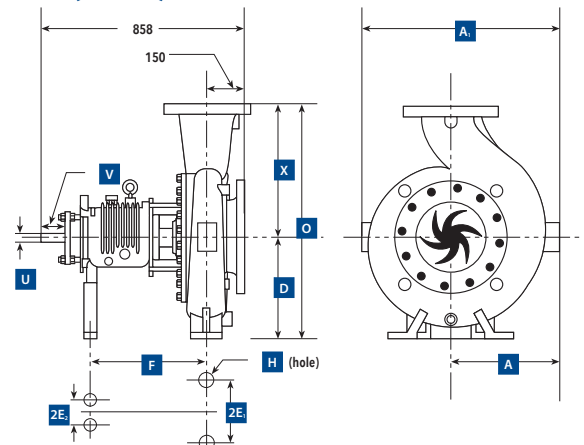

Frame M Pump – ASME/ANSI

Pump Size	A ₁	A	D	2E ₁	2E ₂	F	H	O	U	V	X	
1	6 x 8-13	25.50	14.00	14.50	16.00	9.00	18.75	0.875	30.50	2.375	4.00	16
2	6 x 8-15	27.25	14.75	14.50	16.00	9.00	18.75	0.875	32.50	2.375	4.00	18
3	8 x 10-13	27.25	15.25	14.50	16.00	9.00	18.75	0.875	32.50	2.375	4.00	18
4	8 x 10-15	28.75	15.75	14.50	16.00	9.00	18.75	0.875	33.50	2.375	4.00	19

All dimensions are in inches.

Frame M Pump – Metric

Pump Size	A ₁	A	D	2E ₁	2E ₂	F	H	O	U	V	X	
1	6 x 8-13	648	356	368	406	229	476	22	775	60	102	406
2	6 x 8-15	692	375	368	406	229	476	22	826	60	102	457
3	8 x 10-13	692	387	368	406	229	476	22	826	60	102	457
4	8 x 10-15	730	400	368	406	229	476	22	851	60	102	483

All dimensions are in millimeters.

	6 x 8-13	6 x 8-15	8 x 10-13	8 x 10-15
Shaft				
L3/D4 Ratio	17.98 (.87)	17.22 (.83)	19.85 (.96)	19.55 (.94)
Diameter at Impeller	1.50-8UN (38)			
Diameter at Seal	2.625 (66.7)			
Diameter Between Bearings	3.25 (82.6)			
Diameter at Coupling	2.375 (60.3)			
Bearings				
Thrust	7314 BEGAY			
Thrust Option	N/A			
Radial	6314 C3			
Bearing Span	10.53 (267)			
Shaft Overhang	9.49 (241)	9.35 (237)	9.80 (249)	9.75 (248)
Seal Chamber				
	Standard		Taper	
Seal Bore Diameter (nose)	3.627 (92)		3.627 (92)	
Inside Bore	4.125 (105)		4.125 Minimum (105)	
Depth	2.56 (65)		3.56 (90)	
Back Cover/Shaft Clearance	.02 (Radial) (.50)		.75 (Radial) (19)	
Gland Bolting	4X .625-11UNC On 5.75 Bolt Circle Diameter (16 on 146 AC)			
Distance to Nearest Obstruction	3.13 (79.5)			
Open Impeller				
Clearance	.06 Total .015 Suction Side (1.5 total 0.4 Suction Side)			
Eye Area sq. in. (cm ²)	45 (290)	50 (322)	60 (387)	63 (406)
Maximum Dia. Solids	1.00 (25)	1.13 (29)	1.50 (38)	1.19 (30)
Number of Vanes	6	6	5	6
Pumps Weights lbs (kg)/Vanes				
Pump Only	545 (245)	618 (278)	657 (296)	730 (329)
Casing/Vanes				
Type	Double Volute			
Wall Thickness	0.75 Minimum (19)			
Maximum Working Pressure	See Pressure vs. Temperature Limit Chart			
Test pressure	Class 150 Flanges-250PSIG, Class 300 Flanges-450PSIG			
Rotating Element				
Wk ² Dry lbs/ft ² (kg-m ²)	3.68 (.154)	4.9 (.206)	5.75 (.242)	7.65 (.321)
Wk ² Wet lbs/ft ² (kg-m ²)	5.19 (.218)	6.91 (.290)	8.11 (.341)	10.8 (.454)
Maximum Speed (oil lube)	4000 RPM			
Power Limits				
HP (KW)/100 RPM 316SS	14.25 (10.65)			

Reference drawings A40210, A40211

Cylindrical Bore

Large seal chamber volume provides optimum volume for seal lubrication and cooling.

Cast restriction bushing reduces fluid exchange between casing and seal chamber and allows maximum cooling of fluid. Other bushing options are available including carbon and SpiralTrac®.

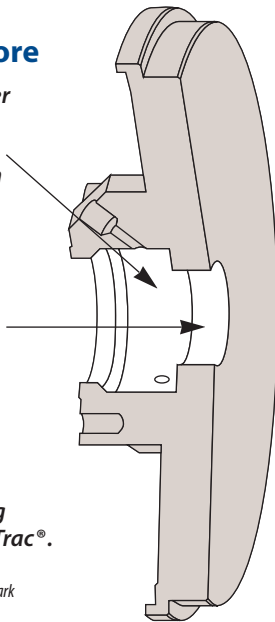

Two industry-tested seal chamber designs provide the right seal environment for virtually any process application.

Large volume seal chambers accept standard sized glands.

Available seal chamber jackets provide optimum cooling or heating of seal chamber fluid to maximize seal life.

Taper Bore

Vortex breakers alter seal chamber flow patterns to move solids out and away from the seal.

Air or gas buildup can be detrimental to seal life. Taper design allows trapped air and gases to escape.

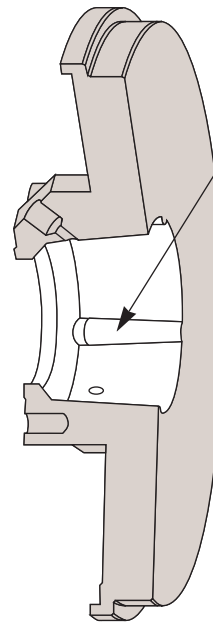

SpiralTrac® is a registered trademark of the manufacturer, EnviroSeal Engineering Products Ltd., Waverly, Nova Scotia.

Blackmer® Centrifugal Assembly & Parts List | Frame M

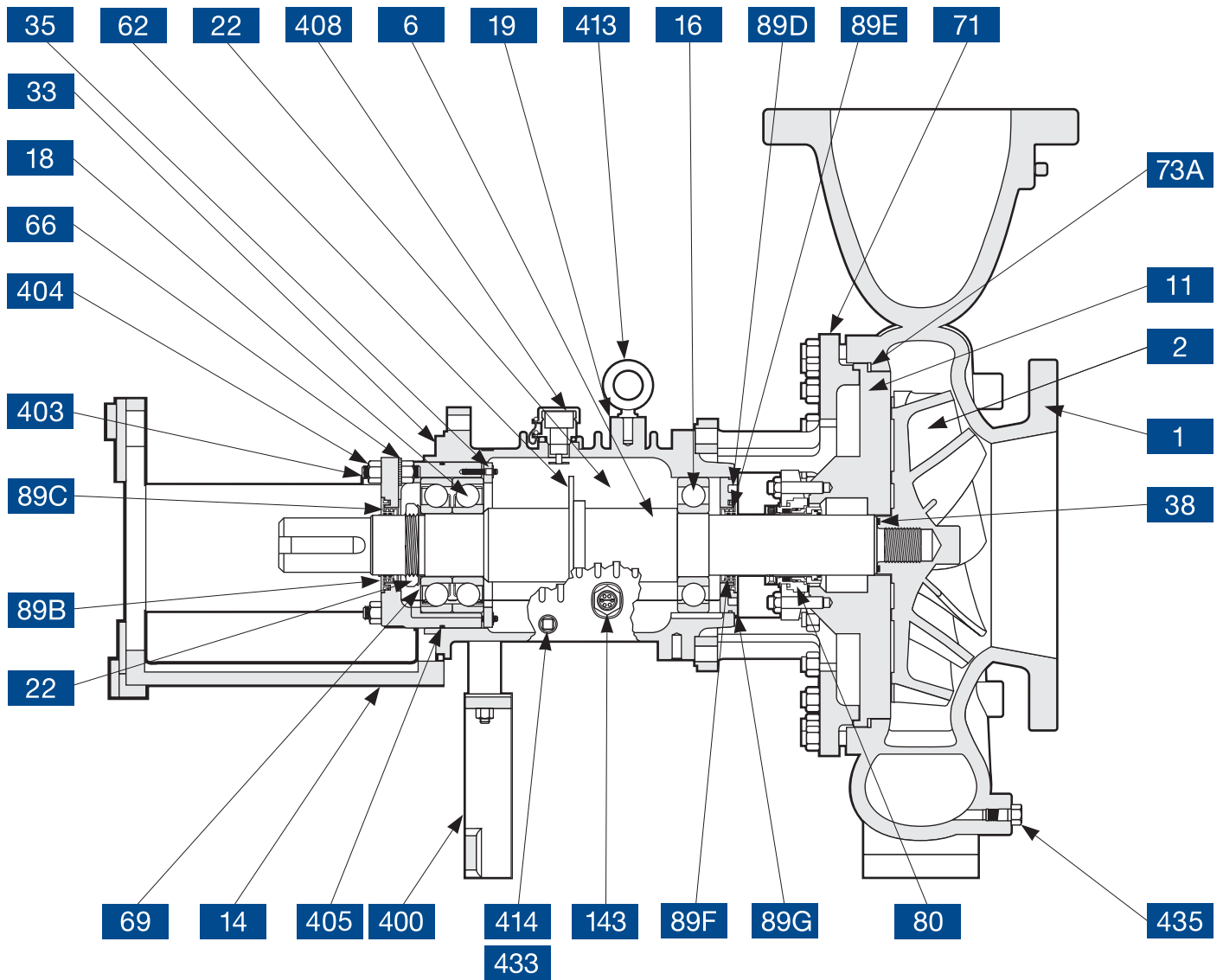

NO.	ITEM	NO.	ITEM	NO.	ITEM
1	Casing	62	Flinger	143	Oil Sight Glass
2	Impeller	66	Micrometer Nut	400	Foot, Bearing Frame
6	Shaft	69	Lockwasher, Thrust Bearing	403	Stud, Cartridge
11	Back Cover	71	Frame Adapter	404	Locknut, Cartridge
14	C Frame motor Adapter	73A	Gasket, Casing	405	O-Ring, Cartridge
16	Bearing, Radial	80	Mechanical Seal	408	Oil Filler Assembly
18	Bearing, Thrust	89B	Seal, Labyrinth Rotor, Thrust	413	Bolt, Eye
19	Bearing, Frame	89C	Seal, Labyrinth Rotor O-ring, Thrust	414	Plug, Magnetic
22	Locknut, Thrust Bearing	89D	Seal, Labyrinth Stator, Radial	433	Plug, Bearing Frame
33	Bearing Cartridge	89E	Seal, Labyrinth Rotor, Radial	435	Plug, Casing
35	Retainer Cover	89F	Seal, Labyrinth Rotor O-ring, Radial		
38	O-ring, Impeller Hub	89G	Seal, Labyrinth Stator O-ring, Radial		

Blackmer® Centrifugal Auxiliary Pipe Connections List | Frame M

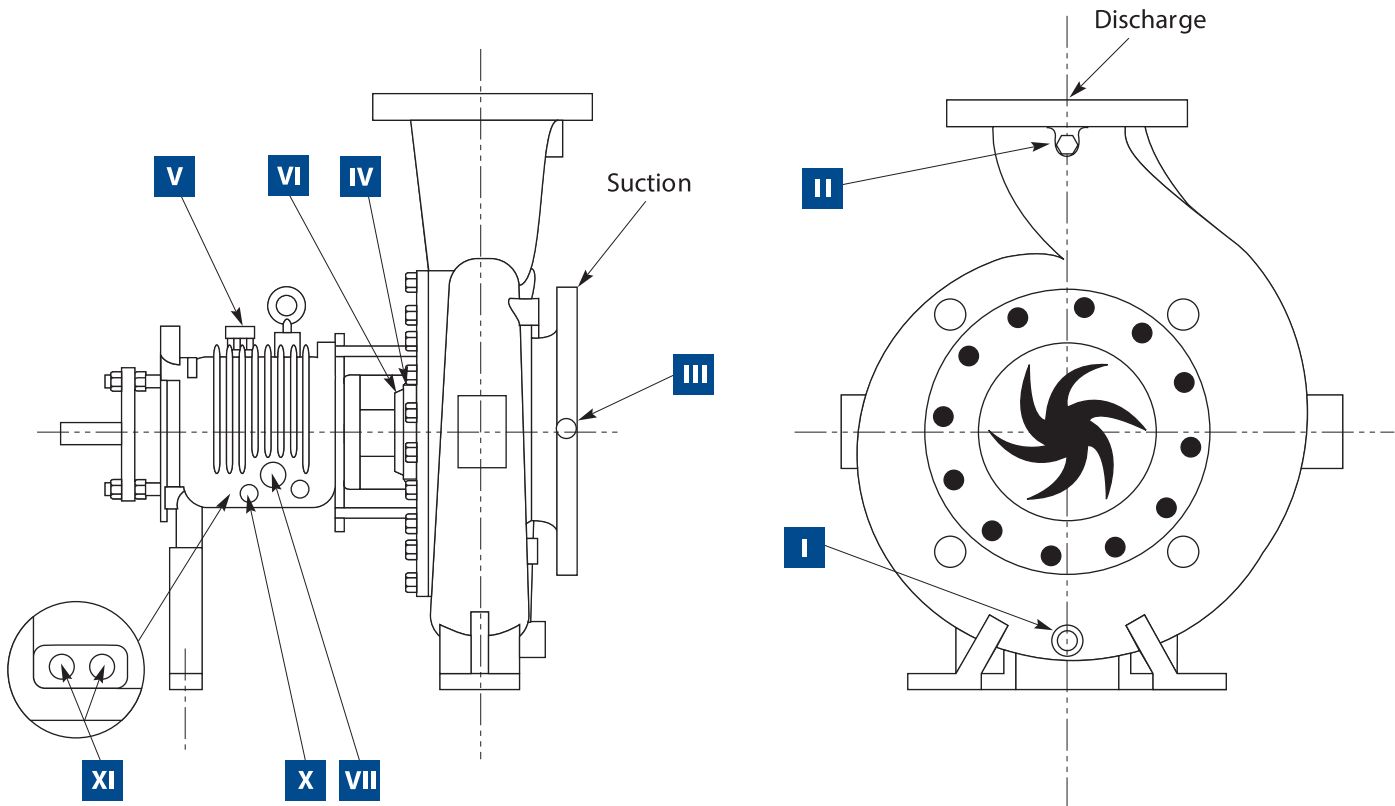

ITEM NUMBER	NPT SIZE	NUMBER OF TAPS	CONNECTION
I	0.50-14	1	Casing Drain
II	0.25-18	1	Discharge Gage
* III	0.25-18	1	Suction Gage
IV	0.50-14	2	Seal Chamber Flush
V	0.75-14	1	Oil Fill
* VI	0.50-14	2	Seal Chamber Jacket inlet & outlet
# VII	1.00-11.5	1	Oil Sight Glass
# X	0.25-18	1	Oil Drain
## XI	0.50-14	2	Plug or (cooling coil*)

*Optional

Left side of pump facing suction end

Right side of pump facing suction end

Blackmer® Centrifugal Composite Pump Curves | Frame M

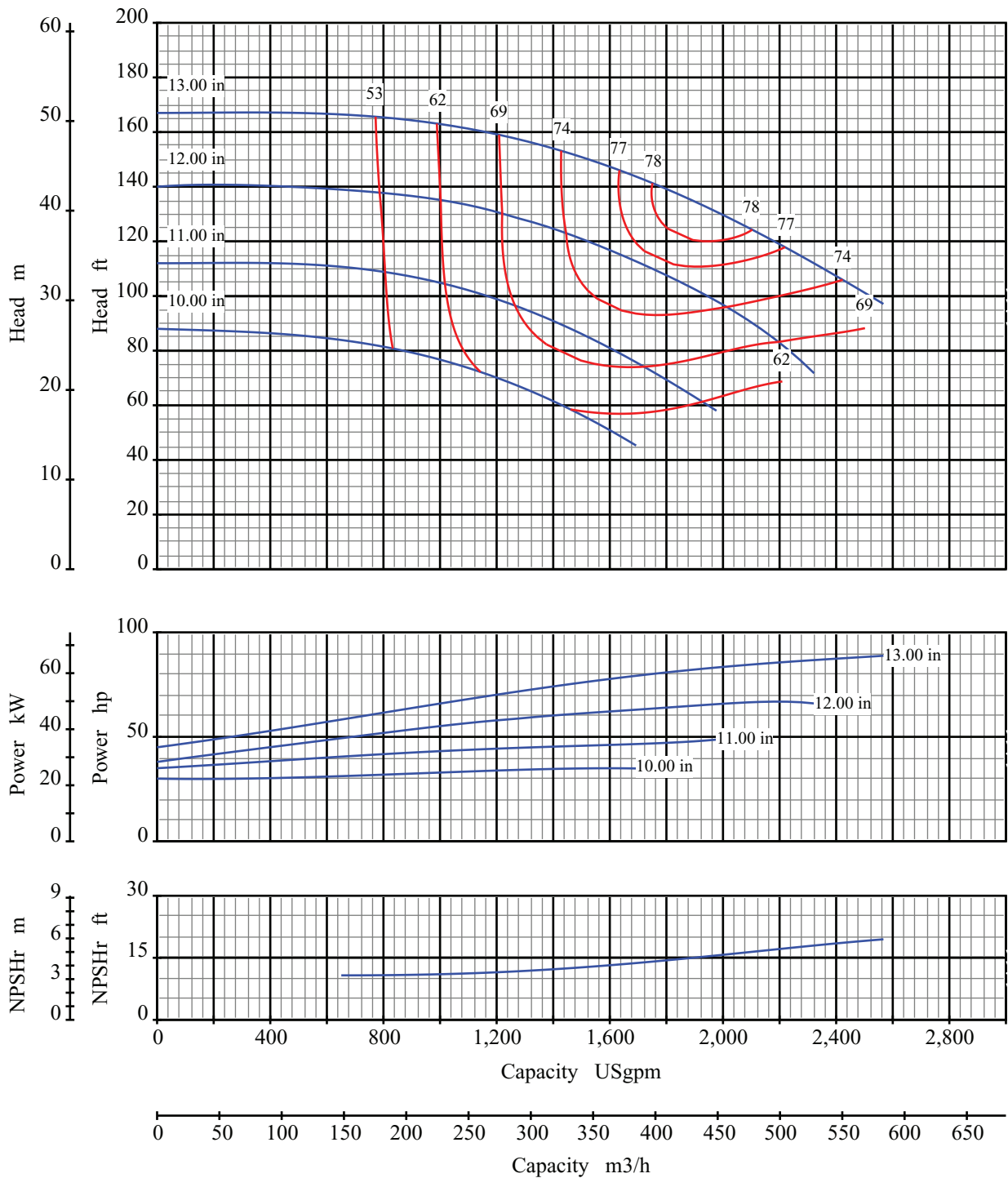

Curve No: S18210V1

Blackmer Centrifugal

Pump Size: 6x8 13

Pump Performance Characteristics

Effective Date: Jan/2005

Catalog: 1301

Speed: 1750 rpm

Open Impeller

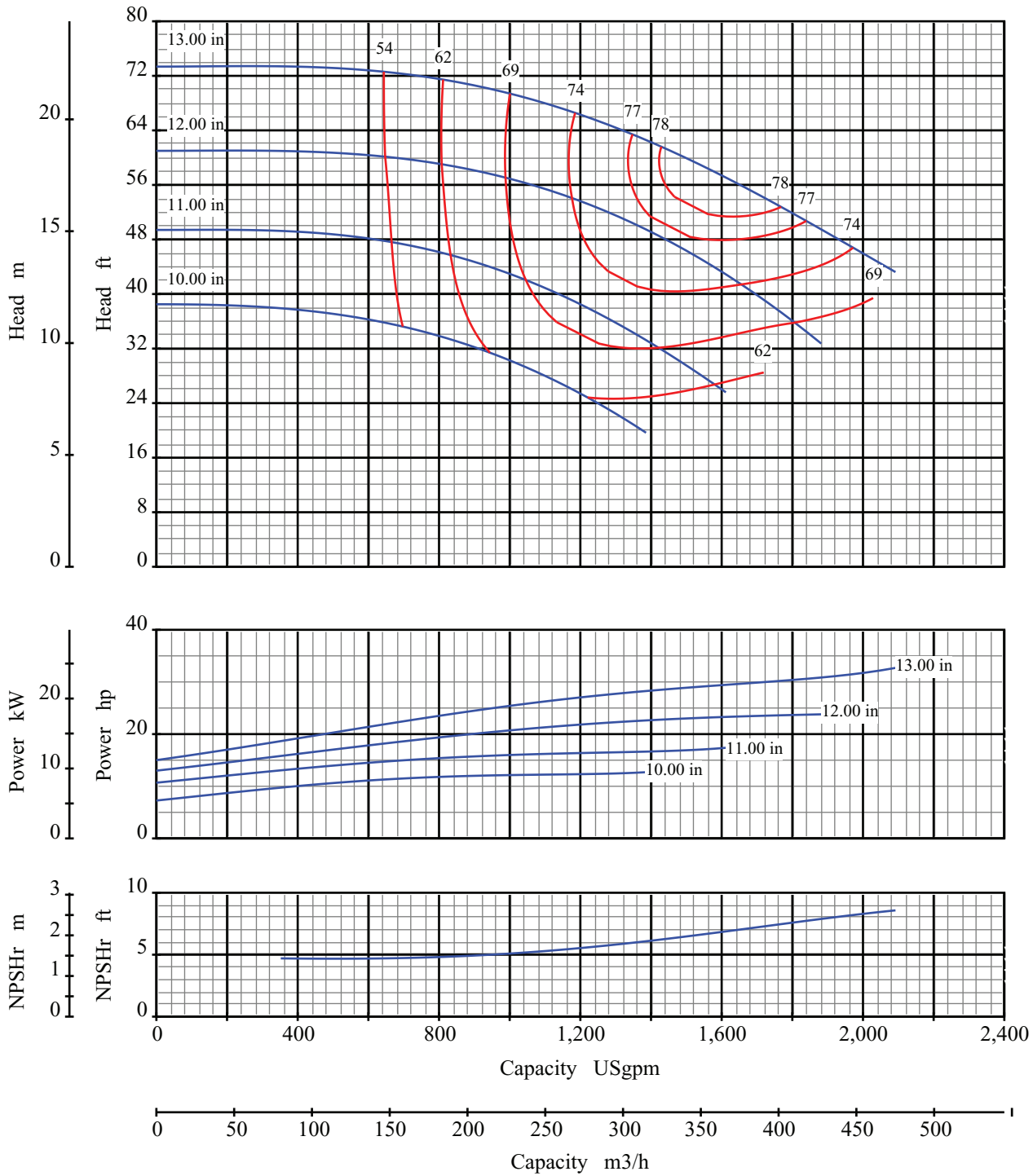

Curve No: S18212V1

Blackmer Centrifugal

Pump Size: 6x8 13

Pump Performance Characteristics

Effective Date: Jan/2005

Catalog: 1301

Speed: 1150 rpm

Open Impeller

Blackmer® Centrifugal Composite Pump Curves | Frame M

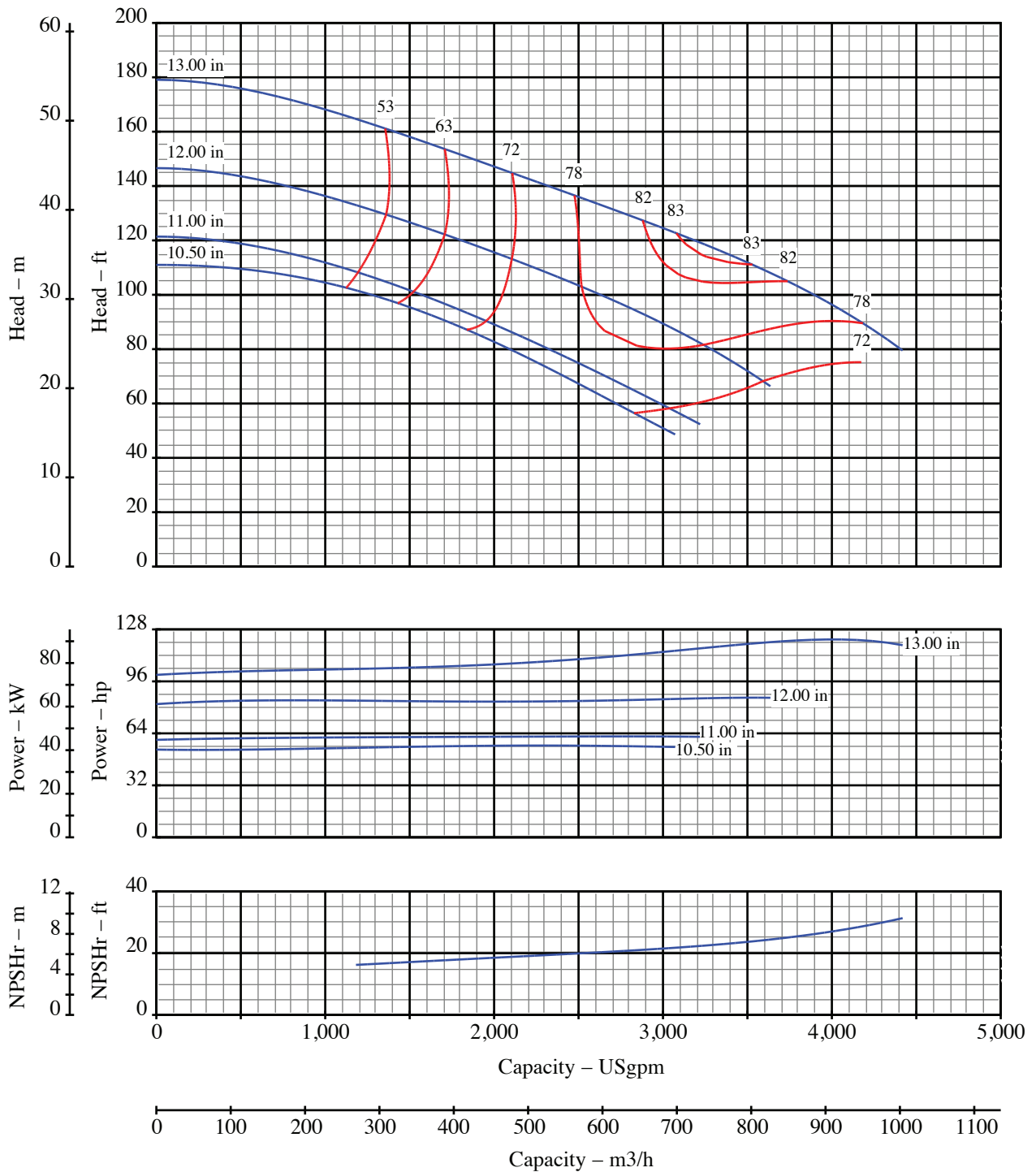

Curve No: S18216V1

Blackmer Centrifugal

Pump Size: 8x10-13

Pump Performance Characteristics

Effective Date: Jan/2005

Catalog: 1301

Speed: 1750 rpm

Open Impeller

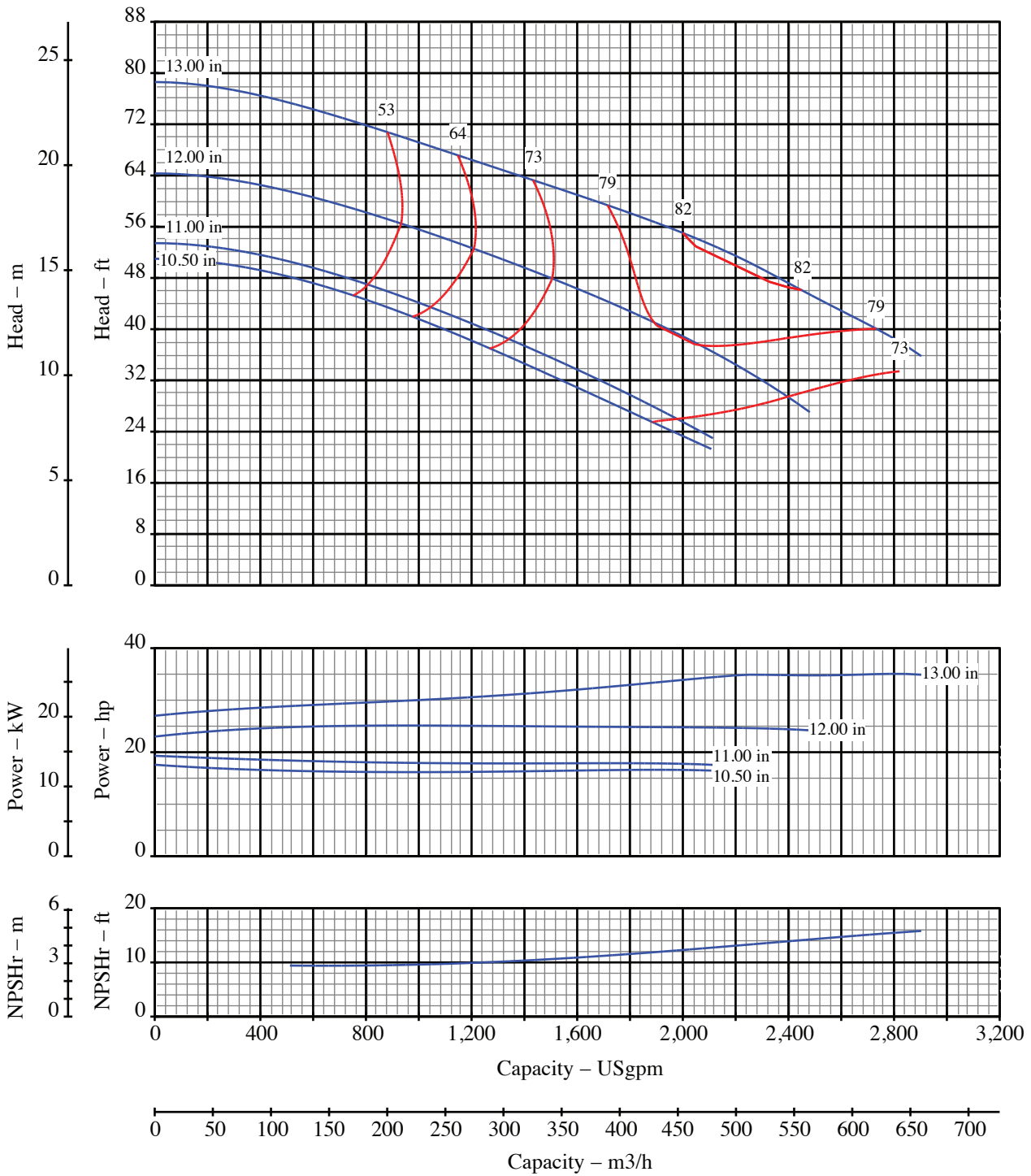

Curve No: S18218V1

Blackmer Centrifugal

Pump Size: 8x10-13

Pump Performance Characteristics

Effective Date: Jan/2005

Catalog: 1301

Speed: 1150 rpm

Open Impeller

Blackmer® Centrifugal Composite Pump Curves | Frame M

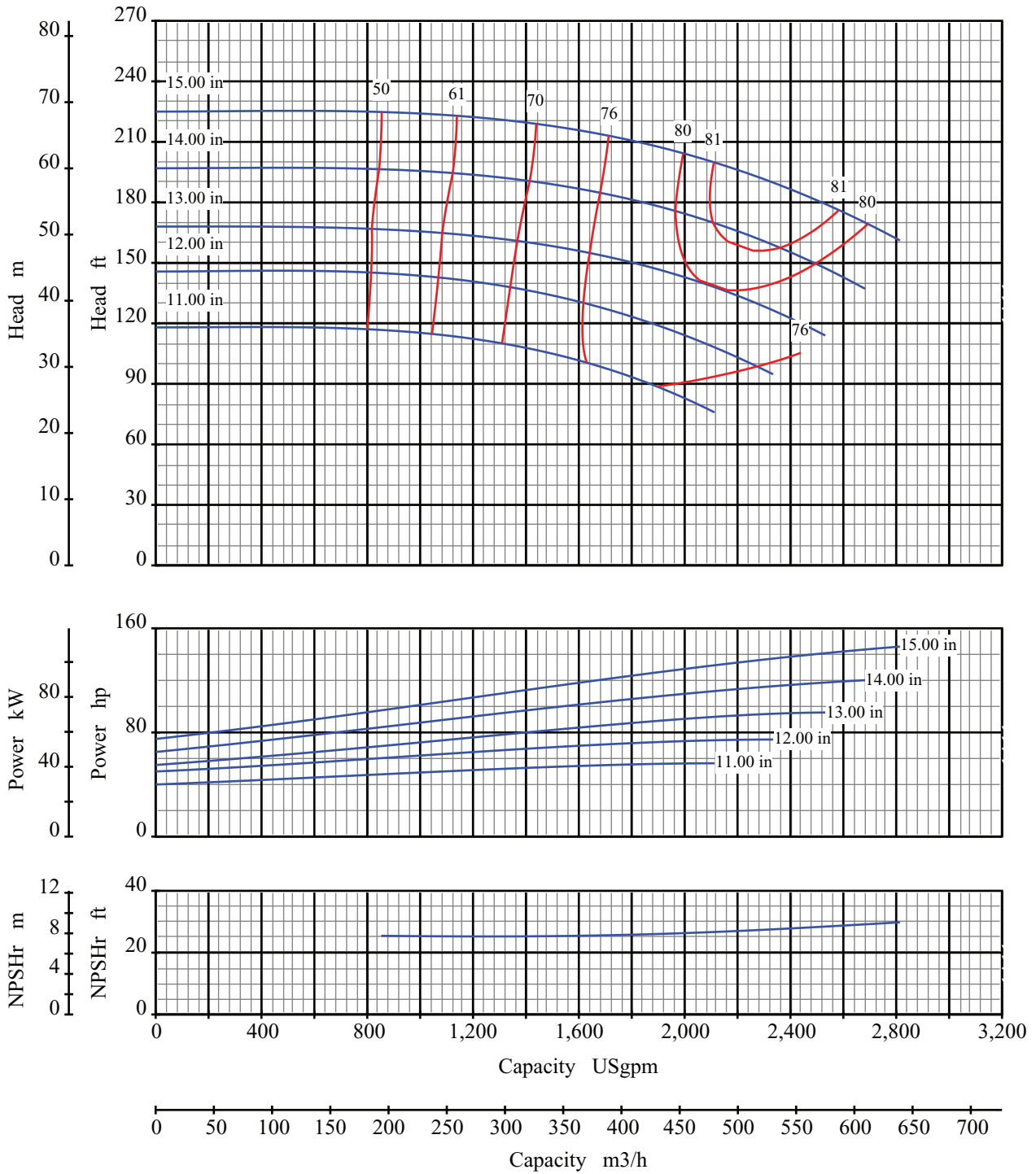

Curve No: S18222V1

Blackmer Centrifugal

Pump Size: 6x8 15

Pump Performance Characteristics

Effective Date: Jan/2005

Catalog: 1301

Speed: 1750 rpm

Open Impeller

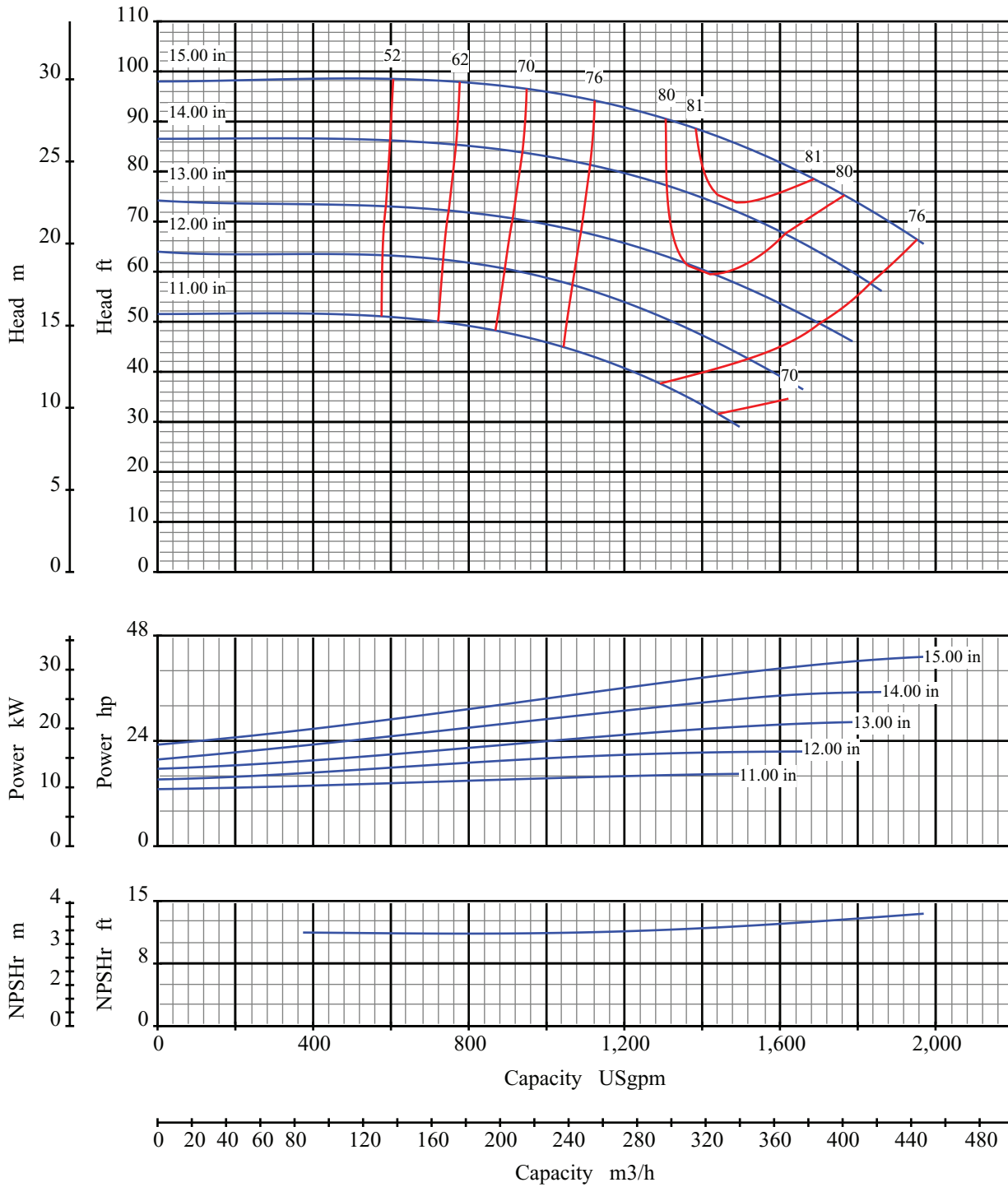

Curve No: S18224V1

Blackmer Centrifugal

Pump Size: 6x8 15

Pump Performance Characteristics

Effective Date: Jan/2005

Catalog: 1301

Speed: 1150 rpm

Open Impeller

Blackmer® Centrifugal Composite Pump Curves | Frame M

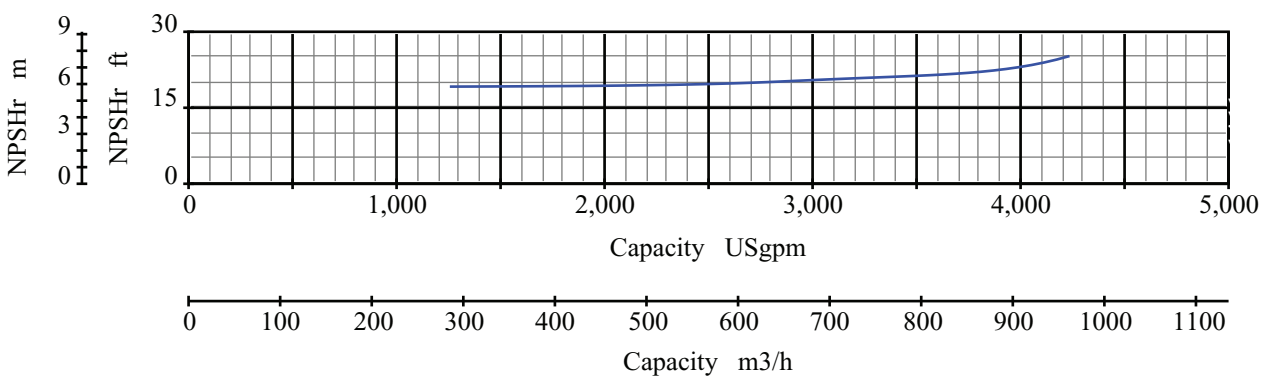
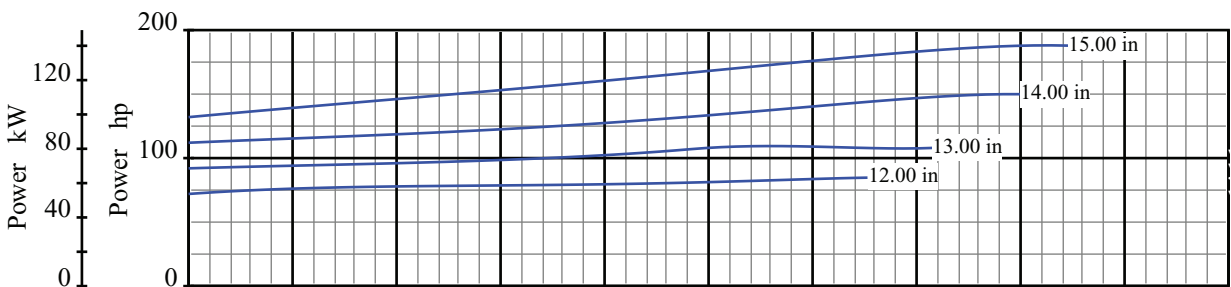
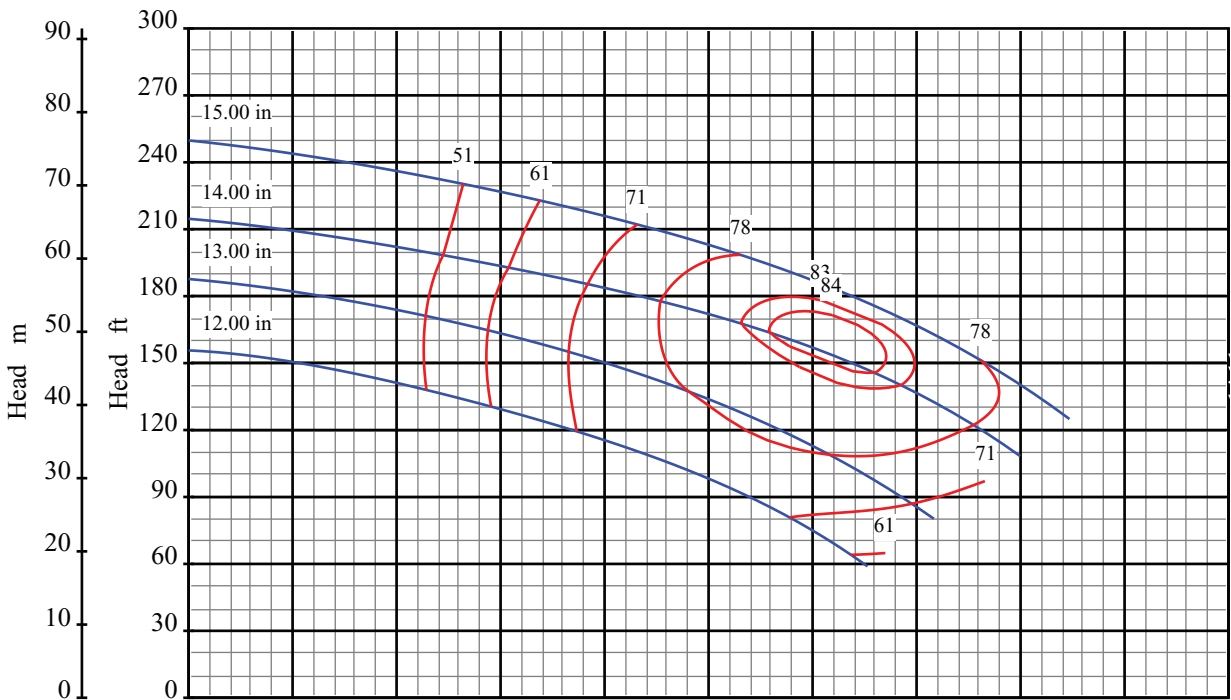

Curve No: S18228V1

Blackmer Centrifugal

Pump Size: 8x10 15

Pump Performance Characteristics

Effective Date: Jan/2005

Catalog: 1301

Speed: 1750 rpm

Open Impeller

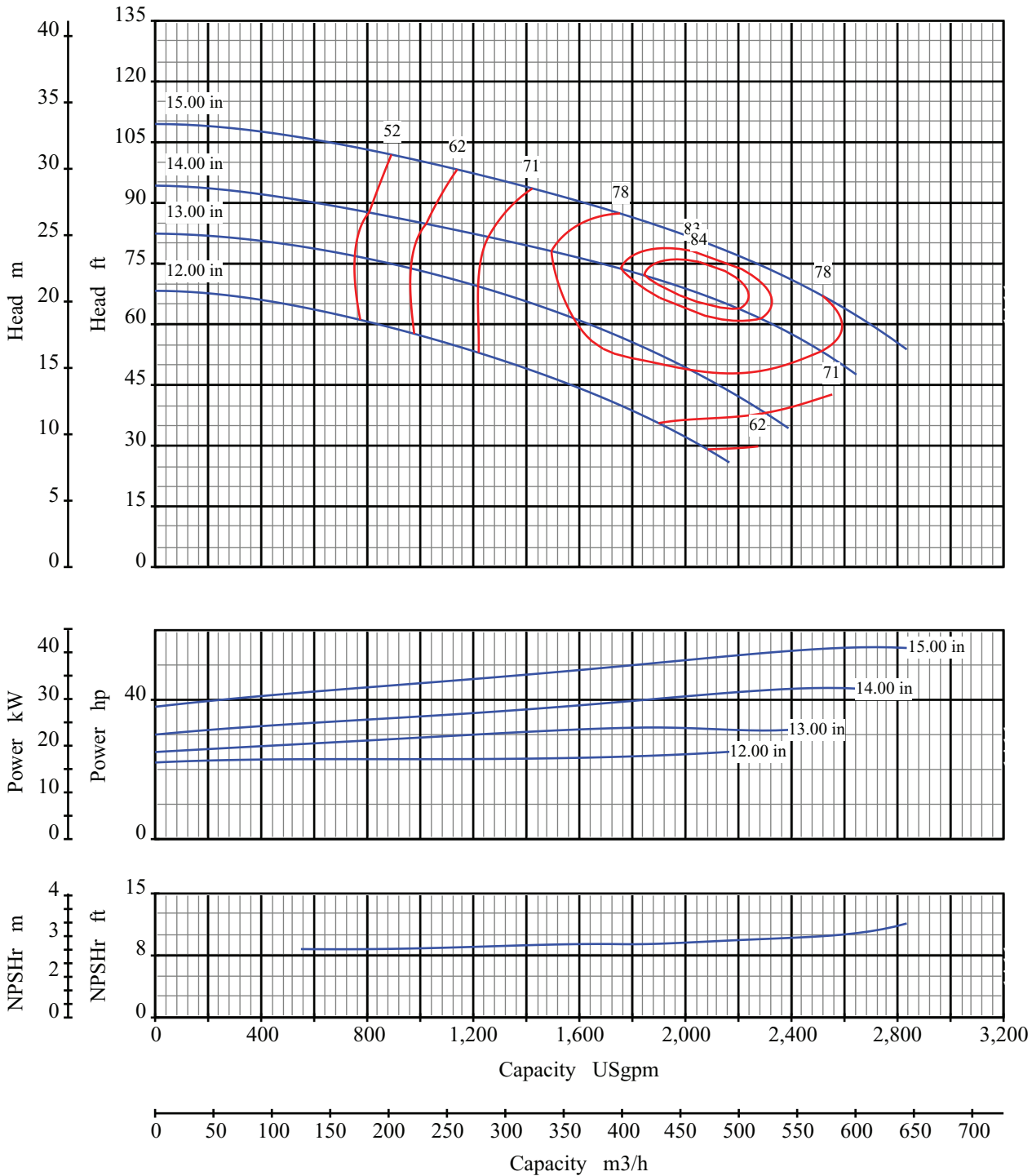

Curve No: S18230V1

Blackmer Centrifugal

Pump Size: 8x10 15

Pump Performance Characteristics

Effective Date: Jan/2005

Catalog: 1301

Speed: 1150 rpm

Open Impeller

Blackmer® Centrifugal Composite Pump Curves | Frame M

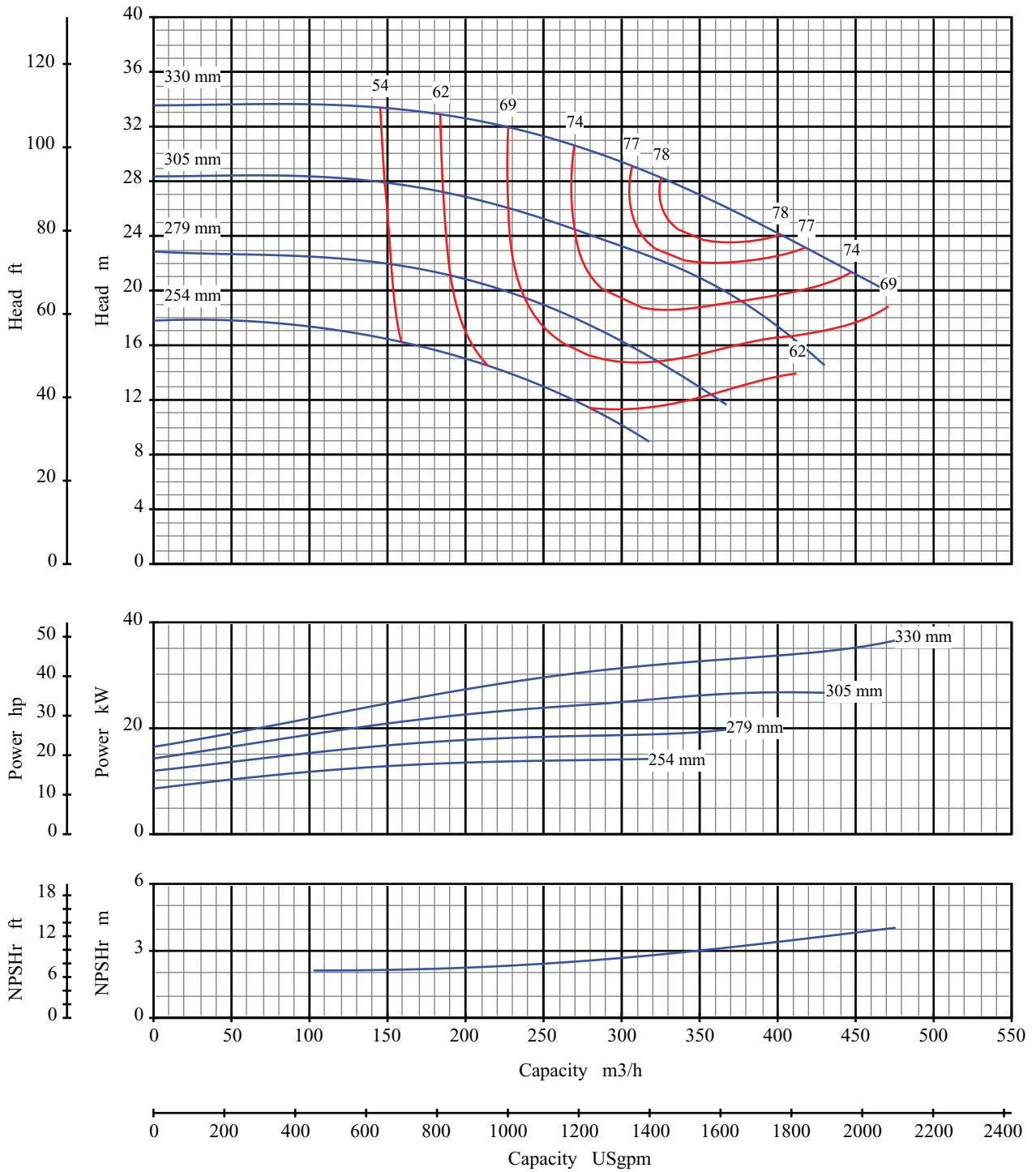

Curve No: S18211V1

Blackmer Centrifugal

Pump Size: 6x8 13

Pump Performance Characteristics

Effective Date: Jan/2005

Catalog: 1301

Speed: 1450 rpm

Open Impeller

Blackmer® Centrifugal Composite Pump Curves | Frame M

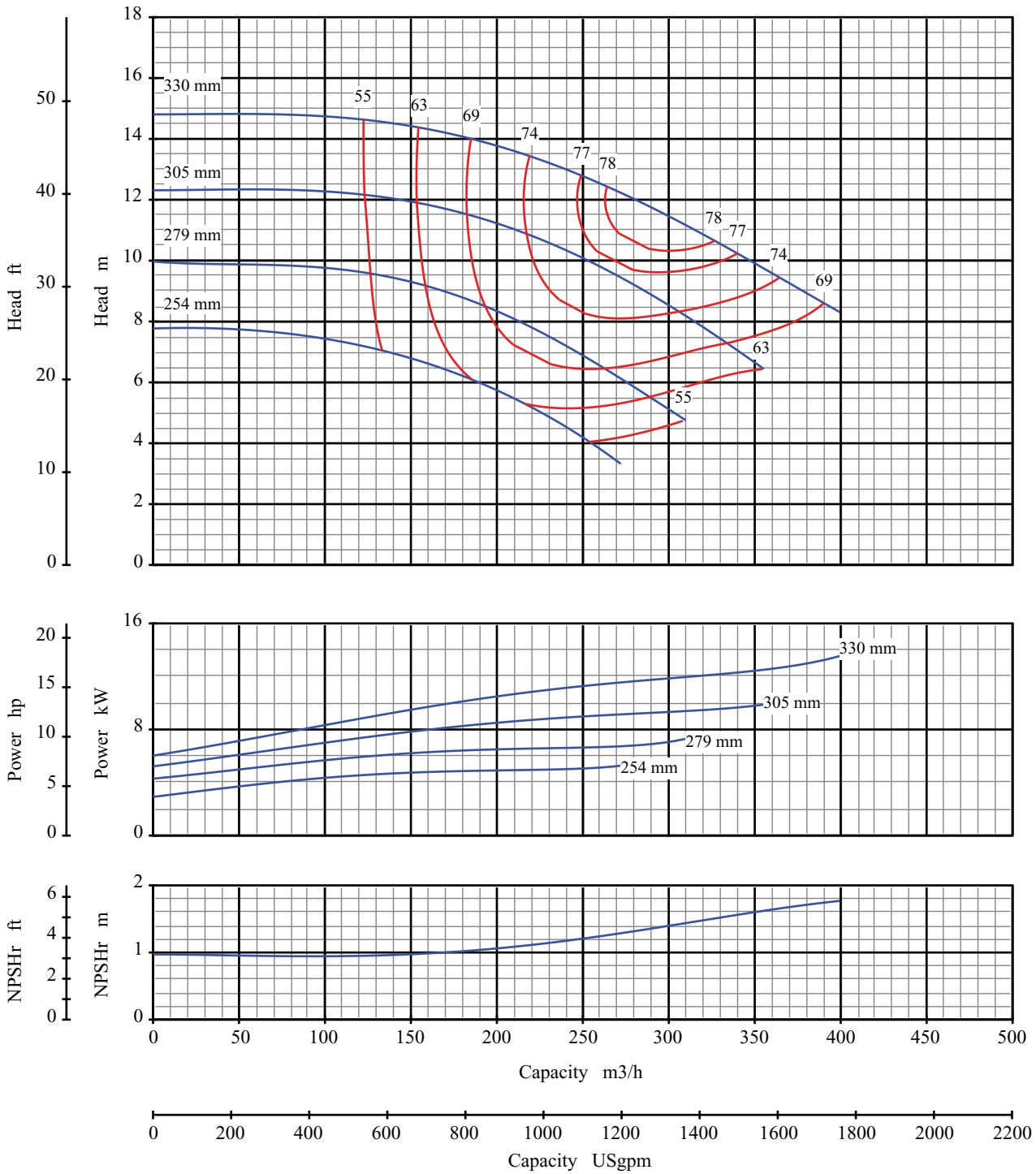

Curve No: S18213V1

Blackmer Centrifugal

Pump Size: 6x8 13

Pump Performance Characteristics

Effective Date: Jan/2005

Catalog: 1301

Speed: 960 rpm

Open Impeller

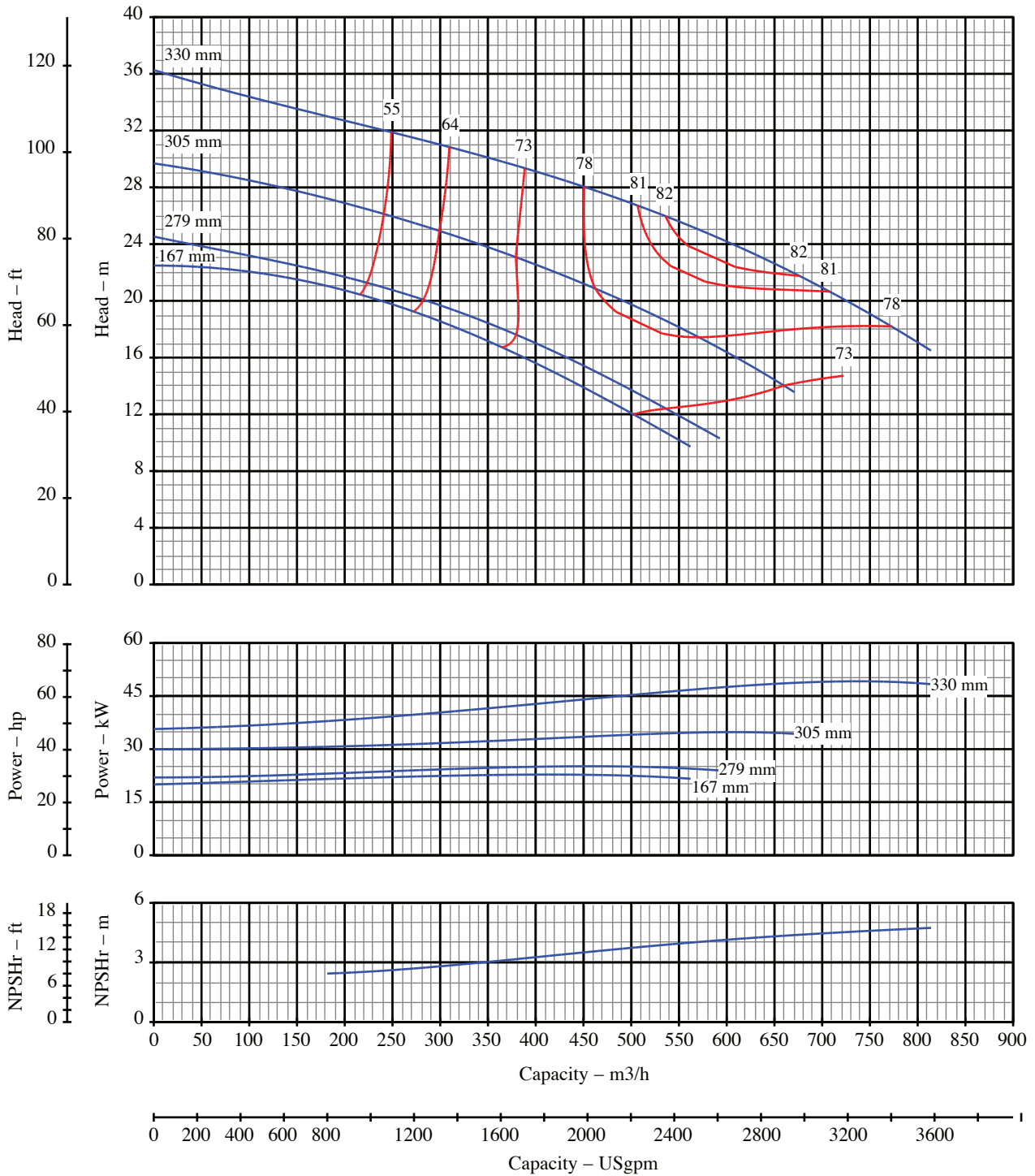

Curve No: S18217V1

Blackmer Centrifugal

Pump Size: 8x10-13

Pump Performance Characteristics

Effective Date: Jan/2005

Catalog: 1301

Speed: 1450 rpm

Open Impeller

Blackmer® Centrifugal Composite Pump Curves | Frame M

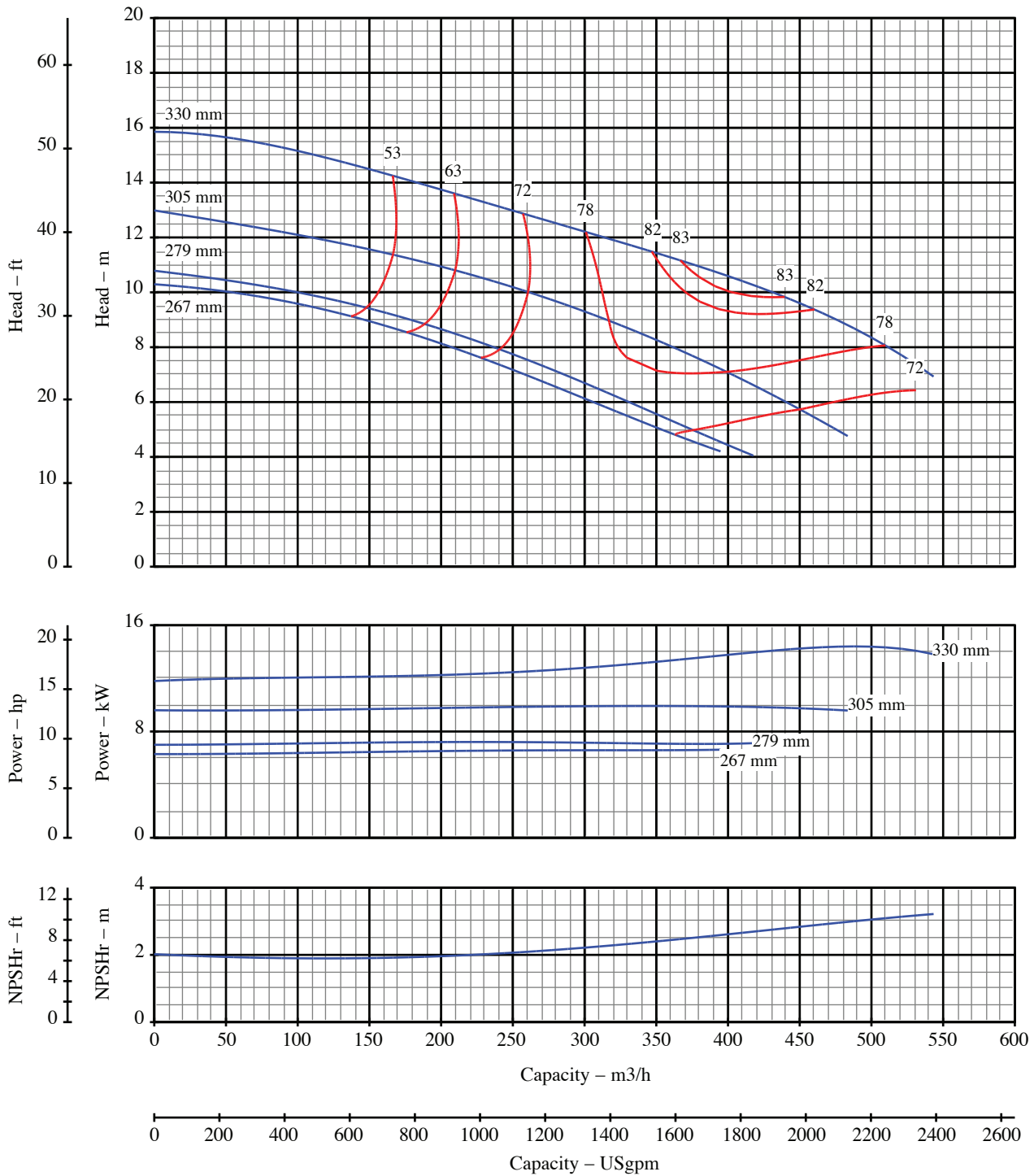

Curve No: S18219V1

Blackmer Centrifugal

Pump Size: 8x10-13

Pump Performance Characteristics

Effective Date: Jan/2005

Catalog: 1301

Speed: 960 rpm

Open Impeller

Blackmer® Centrifugal Composite Pump Curves | Frame M

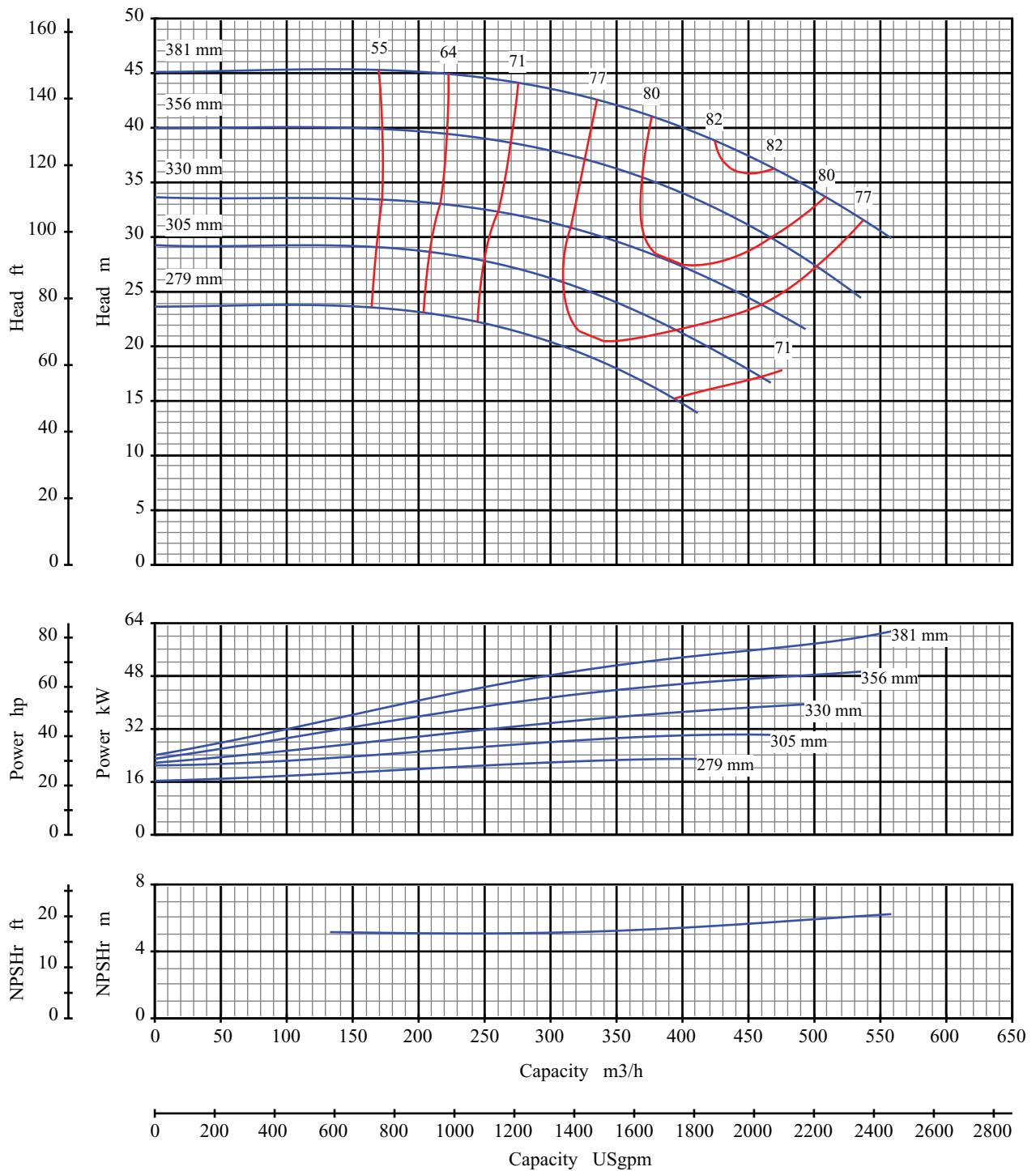

Curve No: S18223V1

Blackmer Centrifugal

Pump Size: 6x8 15

Pump Performance Characteristics

Effective Date: Jan/2005

Catalog: 1301

Speed: 1450 rpm

Open Impeller

Blackmer® Centrifugal Composite Pump Curves | Frame M

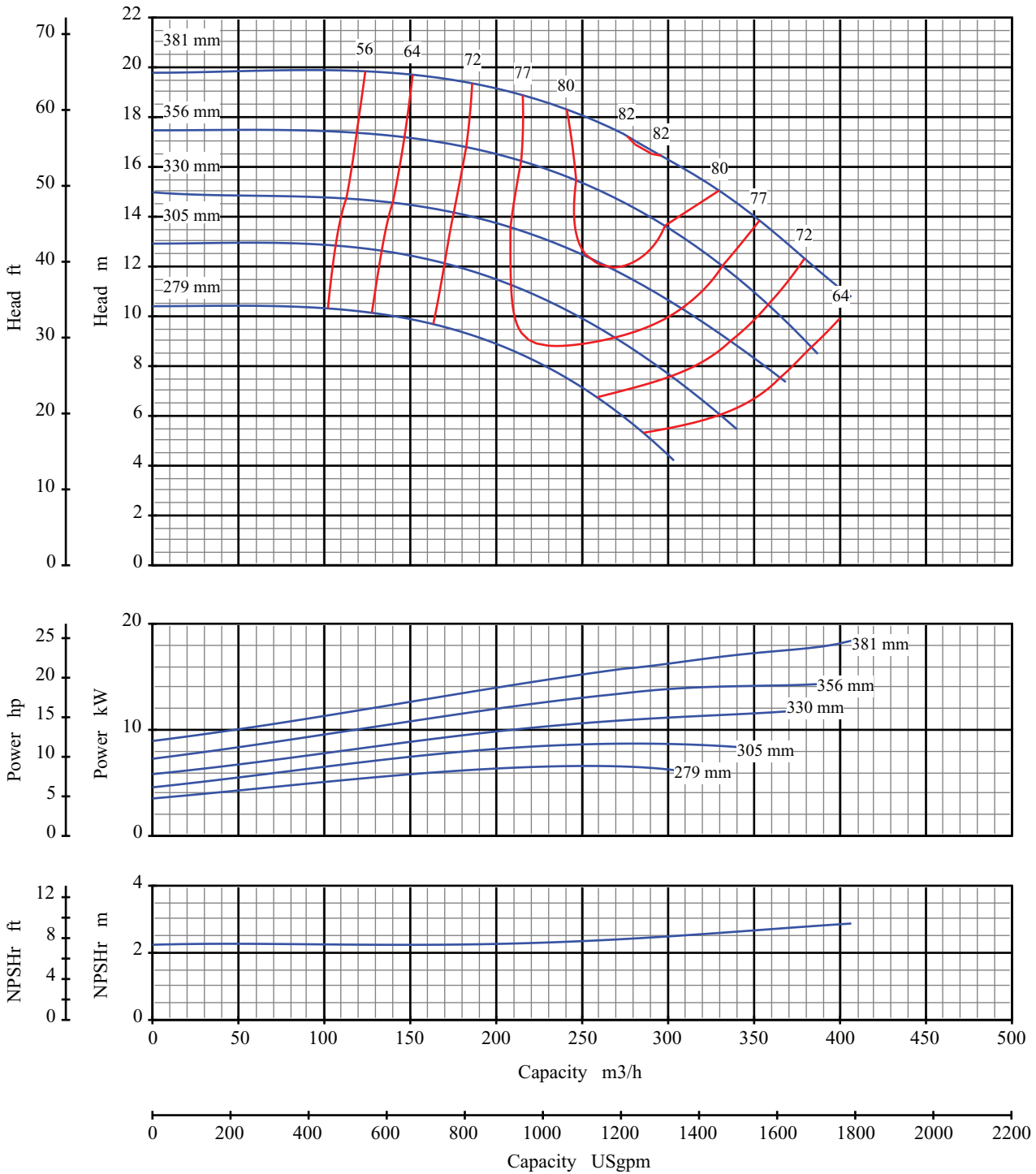

Curve No: S18225V1

Blackmer Centrifugal

Pump Size: 6x8 15

Pump Performance Characteristics

Effective Date: Jan/2005

Catalog: 1301

Speed: 960 rpm

Open Impeller

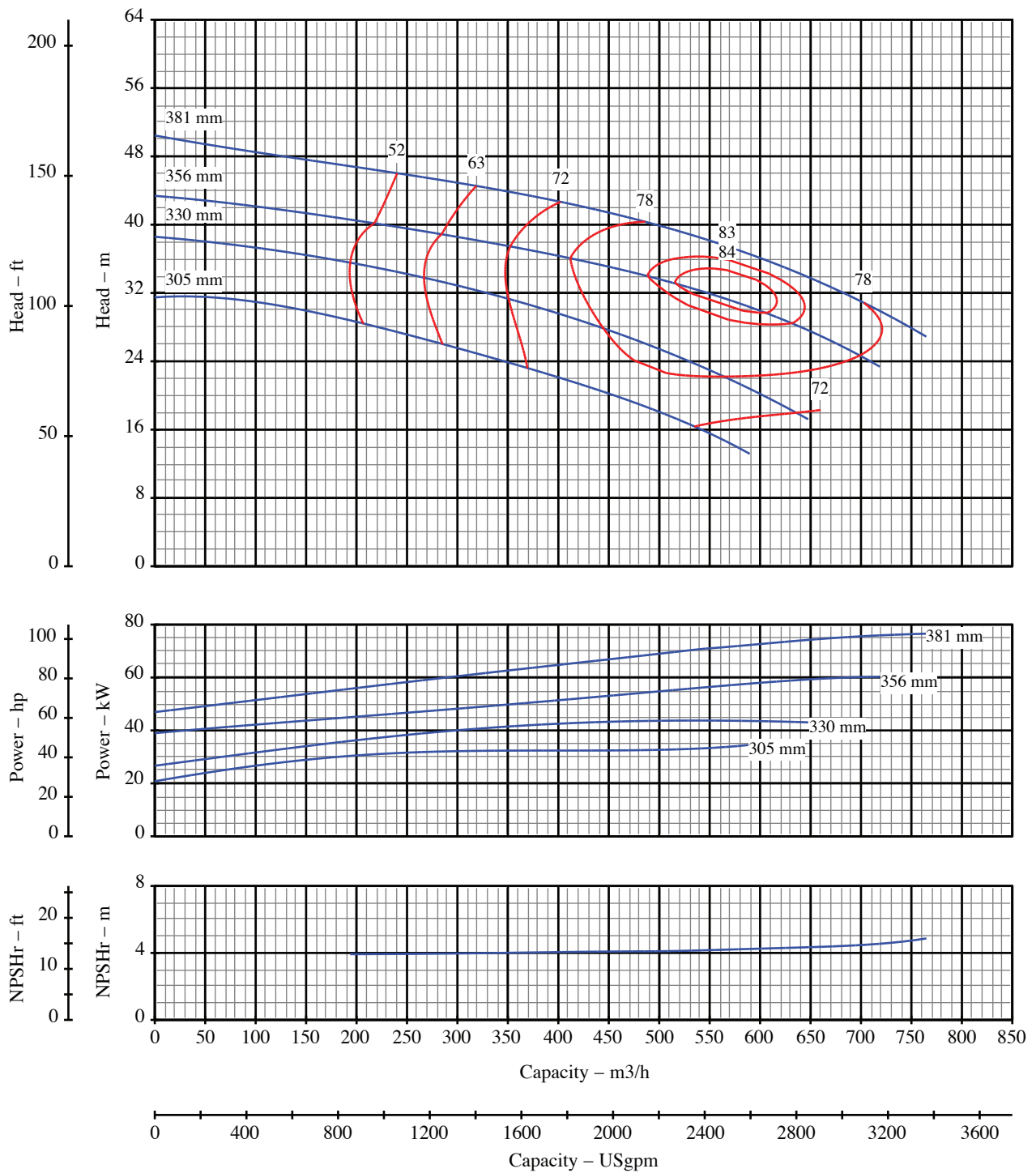

Curve No: S18229V1

Blackmer Centrifugal

Pump Size: 8x10-15

Pump Performance Characteristics

Effective Date: Jan/2005

Catalog: 1301

Speed: 1450 rpm

Open Impeller

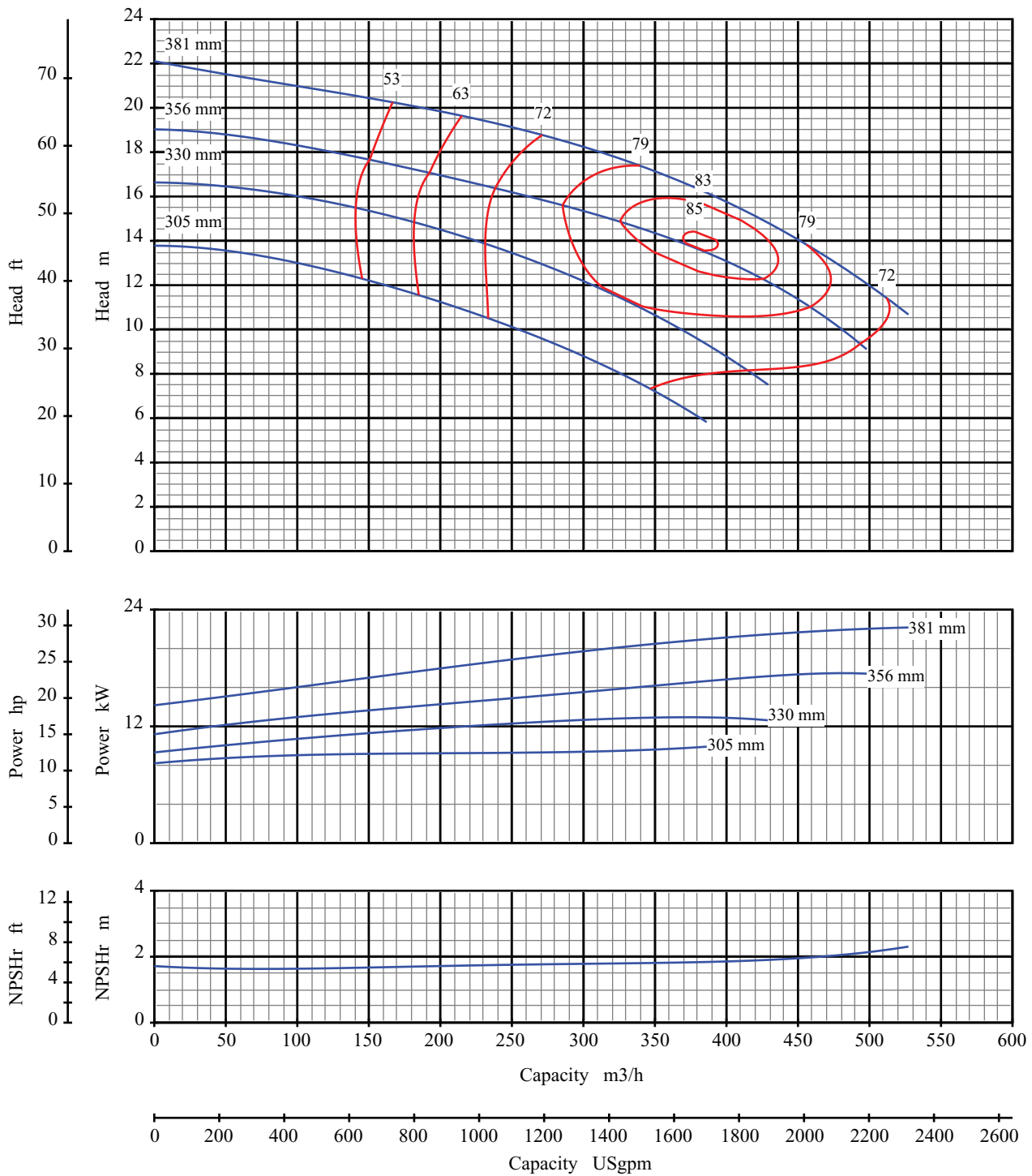

Curve No: S18231V1

Blackmer Centrifugal

Pump Size: 8x10 15

Pump Performance Characteristics

Effective Date: Jan/2005

Catalog: 1301

Speed: 960 rpm

Open Impeller

Blackmer® Centrifugal Pumps



BLACKMER
P1813

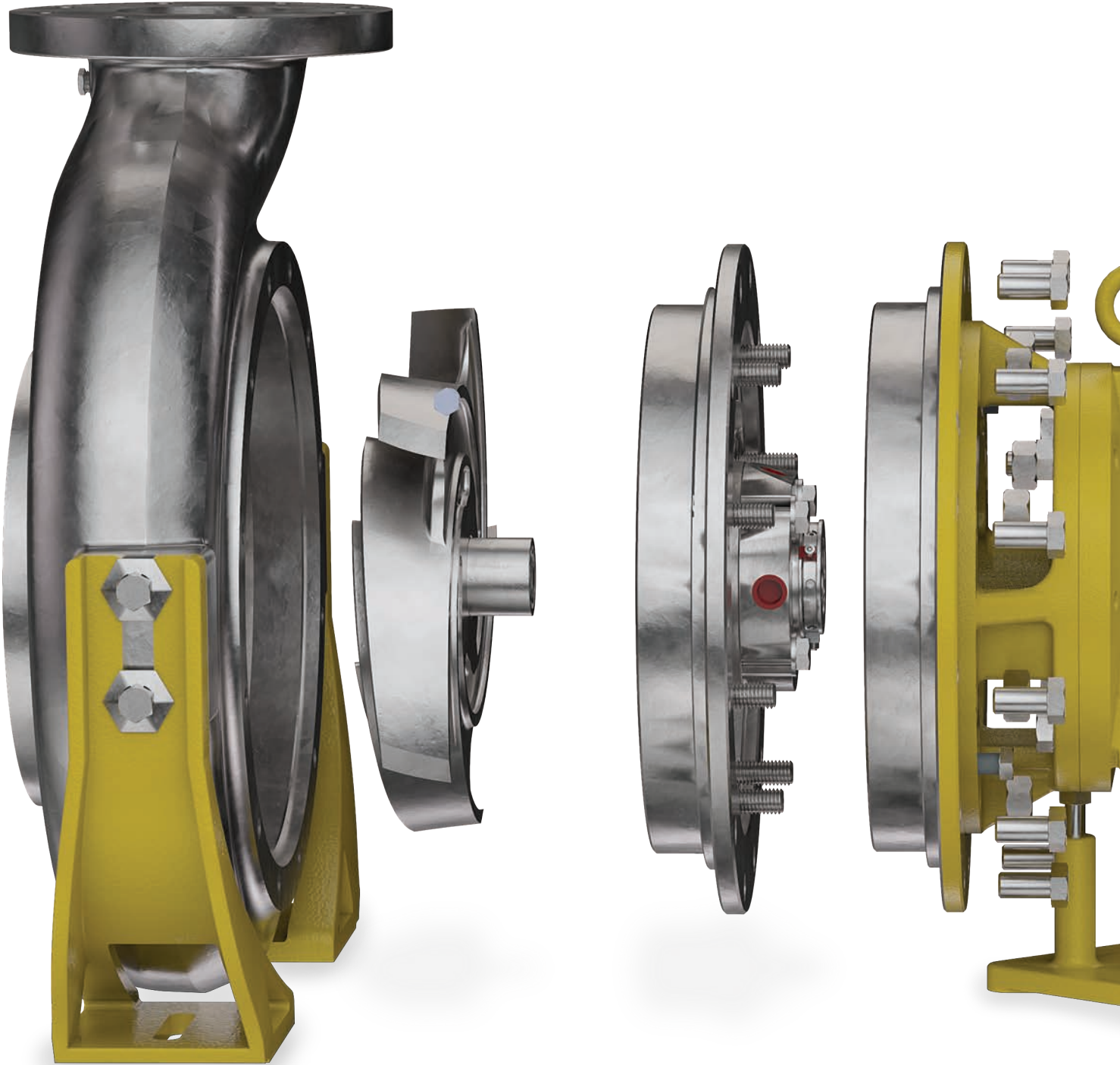

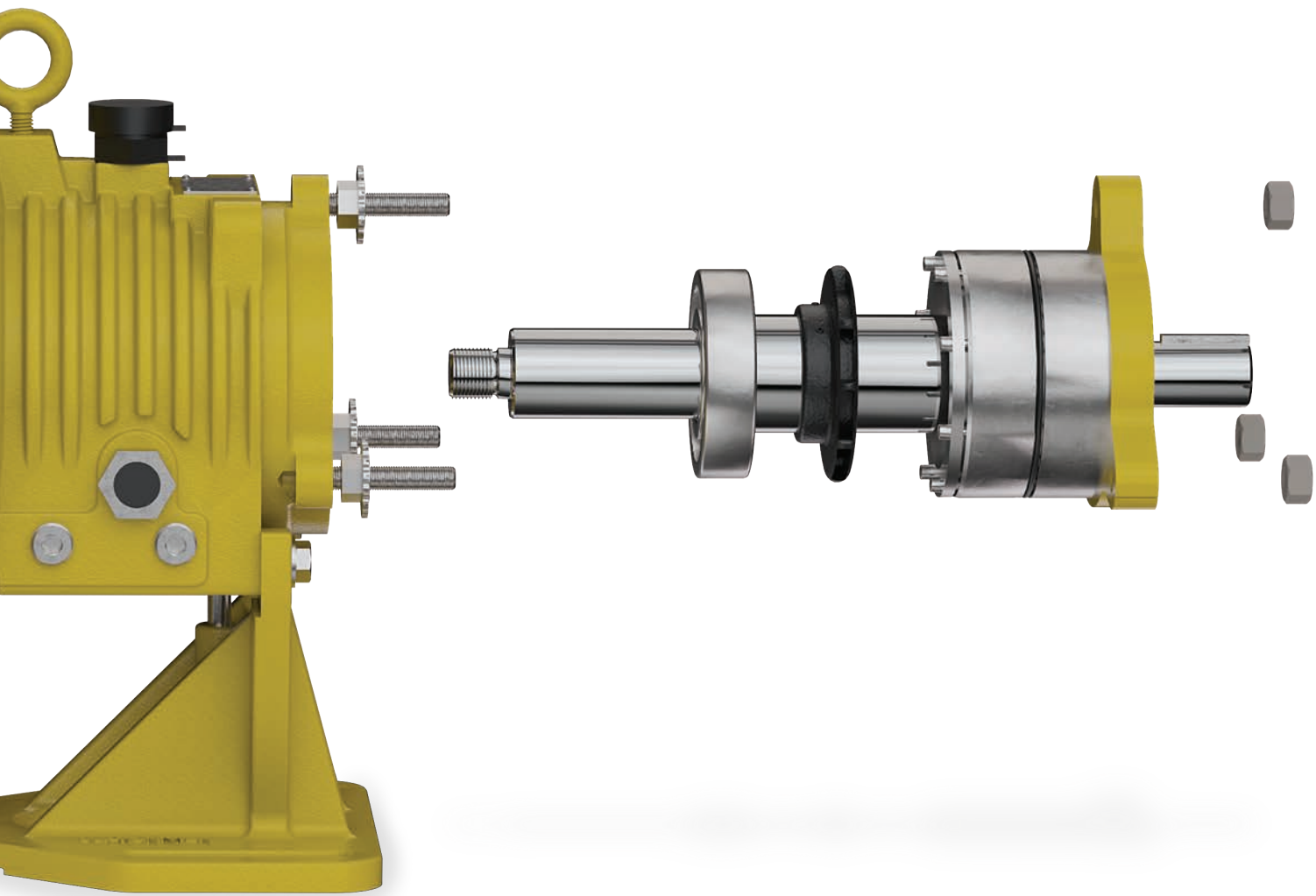

Baseplates

Bent Metal Frames

The standard bent metal steel baseplate for Blackmer® Centrifugal Pumps meets the ANSI dimensional requirements.

Composite Polymer Concrete Baseplates

The optional composite polymer concrete baseplate is corrosion resistant with pre-grouted build, flatness of 0.002" per foot, and 24 times increased vibration damping of steel which provides reduced fatigue on rotating elements.



Custom Design Baseplates

Blackmer Centrifugal Pumps can be integrated into custom design baseplates specifically suited to your application.



Seal Chamber Jacket

A water jacketed seal chamber is available for Frame S, A, and M pumps. The jacket should be considered for any application over 350°F (177°C). When a jacket is installed, ambient temperature water at 2-3 gpm (0.45 to 0.68 m³/hr) will be required for proper cooling of the seal chamber.

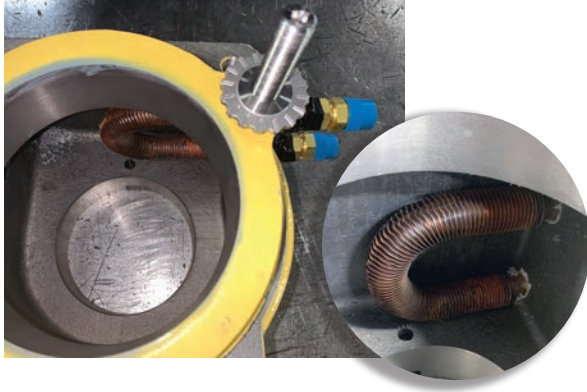

Cooling Coil

Water cooling of the bearing frame is accomplished with the optional cooling coil. The cooling coil allows for oil to be cooled directly, thus cooling the bearings simultaneously. The cooling coil is required only when the pumped media temperature exceeds 400°F (204°C) at 1800 rpm or 300°F (149°C) at 3600 rpm. Under these conditions, ambient temperature water at 1-3 gpm (0.23 to 0.68 m³/hr) will be required for proper cooling of the oil.

Oil Sight Glass

This standard feature on all Blackmer® Centrifugal Pumps allows for easy monitor of the pump oil levels. The oil level in the bearing frame should be one-half (1/2) of the way up the oil sight glass with the unit not operating. Blackmer offers an optional second oil sight glass on the opposite side of the bearing housing for easier monitoring of the oil level.



Oil Temperature Monitor

Normal operating oil temperature should be below 160°F (71°C) and should never exceed 180°F (82°C). The optional oil temperature monitor is recommended for all applications, especially for high temperature. The device simply screws into the 1/4" NPT connection and instantly registers the temperature of the oil.

High Temperature Paint

Blackmer Centrifugal high temperature paint is made from a specially formulated epoxy coating that will not degrade from the high temperatures within the pump. High temperature paint is recommended for pumps operating above 375°F (191°C).



Part Name	# Reg. per Pump	Frame S	Frame A & LD17	Frame M
Casing	1	D.I., 316SS CD-4	D.I., 316SS CD-4	D.I., 316SS CD-4
Casing Gasket	1	1/16" per Application	1/16" per Application	1/16" per Application
Casing Foot	2	Steel	D.I./Centerline	Cast (Steel CL option)
Impeller	1	CD4MCu	CD4MCu	D.I., CD4MCu
Impeller Hub O-Ring Seal	1	PTFE	PTFE	PTFE
Suction Cover	1	N/A	N/A	N/A
Back Cover	1	D.I., 316SS CD-4	D.I., 316SS CD-4	D.I., 316SS CD-4
Mechanical Seal Assembly	1	Refer to Seal Dwg.	Refer to Seal Dwg.	Refer to Seal Dwg.
Shaft – bimetallic standard (Steel w/alloy wetted end)	1	316SS	316SS 17-4 Ph	316SS
Radial Bearing	1	6308	6310	6314
Thrust Bearing	2 1	5308 7308 (2) (opt.)	7310 (2)	7314 (2)
Thrust Bearing Locknut	1	Steel N08	Steel N10	Steel N14
Thrust Bearing Lock Washer	1	Steel W08	Steel W10	Steel W14
Flinger	1	N/A	Nylon 66	Alum
Radial Bearing Oil Seal Laby Thrust Bearing Oil Seal Laby	1 1	316SS	316SS	316SS
Thrust Bearing Cartridge	1	D.I.	C.I.	C.I.
Thrust Bearing Retainer Cover	1	Steel	Steel	Steel
Thrust Bearing Cartridge O-Ring	1	Buna	Buna	Buna
Bearing Frame	1	C.I.	C.I.	C.I.
Bearing Frame Foot	1	C.I. option	C.I.	C.I.
Oil Sight Glass	1	Steel-Zinc Plated	Steel-Zinc Plated	Steel-Zinc Plated
Frame Adaptor and O-Ring	1	N/A	D.I./C.I. Buna	D.I. Buna
Micrometer Adjustment Nut	3	304SS	304SS	304SS
Cartridge Stud	3	304SS	304SS	304SS
Cartridge Locknut	3	304SS	304SS	304SS
Oil Filler and Cap	1	Nylon 66	Nylon 66	Nylon 66
C-Frame Motor Adaptor	1	C.I.	C.I.	C.I.

Material and equivalent ASTM: A-20 Grade CN7M, ASTM A-743; 316SS Grade CF8M, ASTM A-743; CD4MCu, ASTM A-743;

Shaft, Steel portion, AISI 1018/316SS, ASTM A-276; Shaft 17-4 Ph, ASTM A-276; D.I. Ductile Iron, ASTM A-536; C.I. Cast Iron, ASTM A-48, CL 35.

Blackmer® Centrifugal SpiralTrac¹ Seal Chamber Bushings Innovative Technology for Improvement of the Seal Environment

SpiralTrac is a specially designed bushing that is inserted in the bottom of a seal chamber (or stuffing box if a packed pump) and is made from 316SS, 416SS, carbon graphite or PTFE material.

The SpiralTrac is designed to improve the operating environment for the mechanical seal through the use of a variable geometry spiral grooving system.

During operation, SpiralTrac converts the rotating flow to an axial flow in the seal cavity and drives it away from the seal toward the impeller.





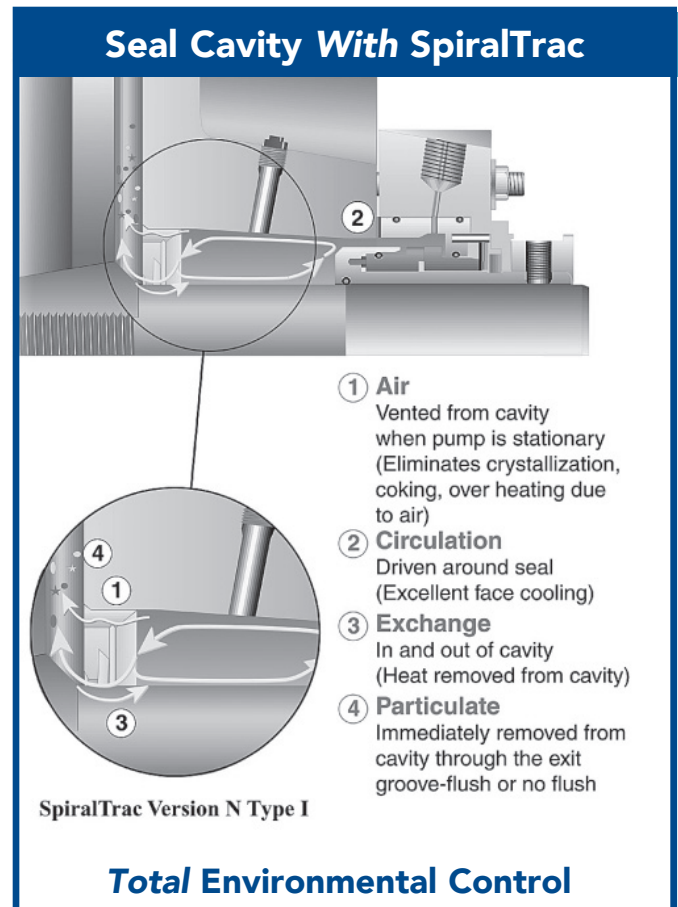
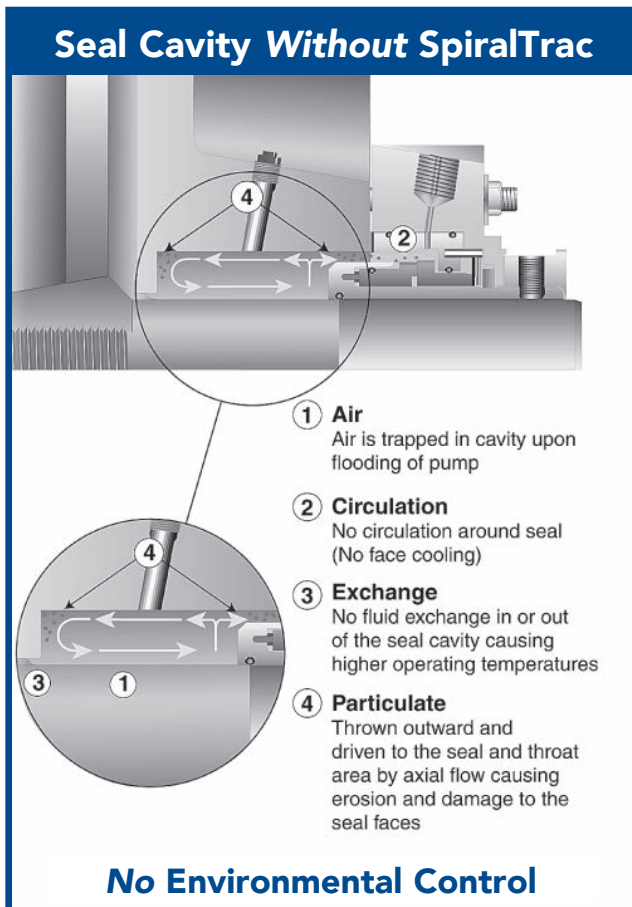





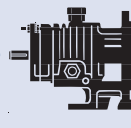

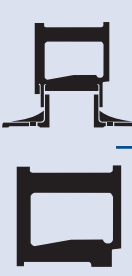
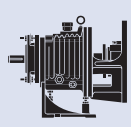
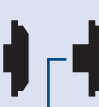

- The contaminants are swept by centrifugal force toward the SpiralTrac and into the groove where the main spiral forces the contaminants out through the exit groove at the shaft.
- SpiralTrac contains a unique air vent in the top of the bushing to purge air on initial pump flooding.
- If the product is aerated or the pump runs dry, an external flush, a single seal with a quench, or a double seal is required.

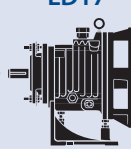
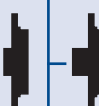
SpiralTrac enables venting of the seal chamber, drives circulation and exchange of fluid, and removes abrasives or contaminants.

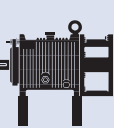

¹ SpiralTrac is a registered trademark of the manufacturer, EnviroSeal Engineering Products Ltd., Waverly, Nova Scotia.

Blackmer® Centrifugal Pumps | Interchangeability Chart

Motor Adaptor	Power End	Back Cover	Impeller Open	Casing	Pump Size ASME/ANSI
	Frame S ASME/ANSI 				1 x 1½ - 6
					2 x 3 - 6
					1 x 1½ - 8
					1½ x 3 - 8
	Frame A ASME/ANSI 				2 x 3 - 8
					3 x 4 - 8
					1 x 2 - 10
					1½ x 3 - 10
					2 x 3 - 10
	LD17 				3 x 4 - 10
					4 x 6 - 10
					1½ x 3 - 13
					2 x 3 - 13
					3 x 4 - 13
	Frame M 				6 x 8 - 13
					8 x 10 - 13
					6 x 8 - 15
					8 x 10 - 15

Blackmer® Centrifugal | ANSI Pressure/Temperature Limits

FRA/LDI7 13" with 300 lb. Flanges

FRM 15" with 300 lb. Flanges

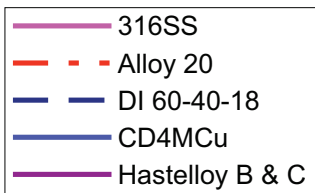
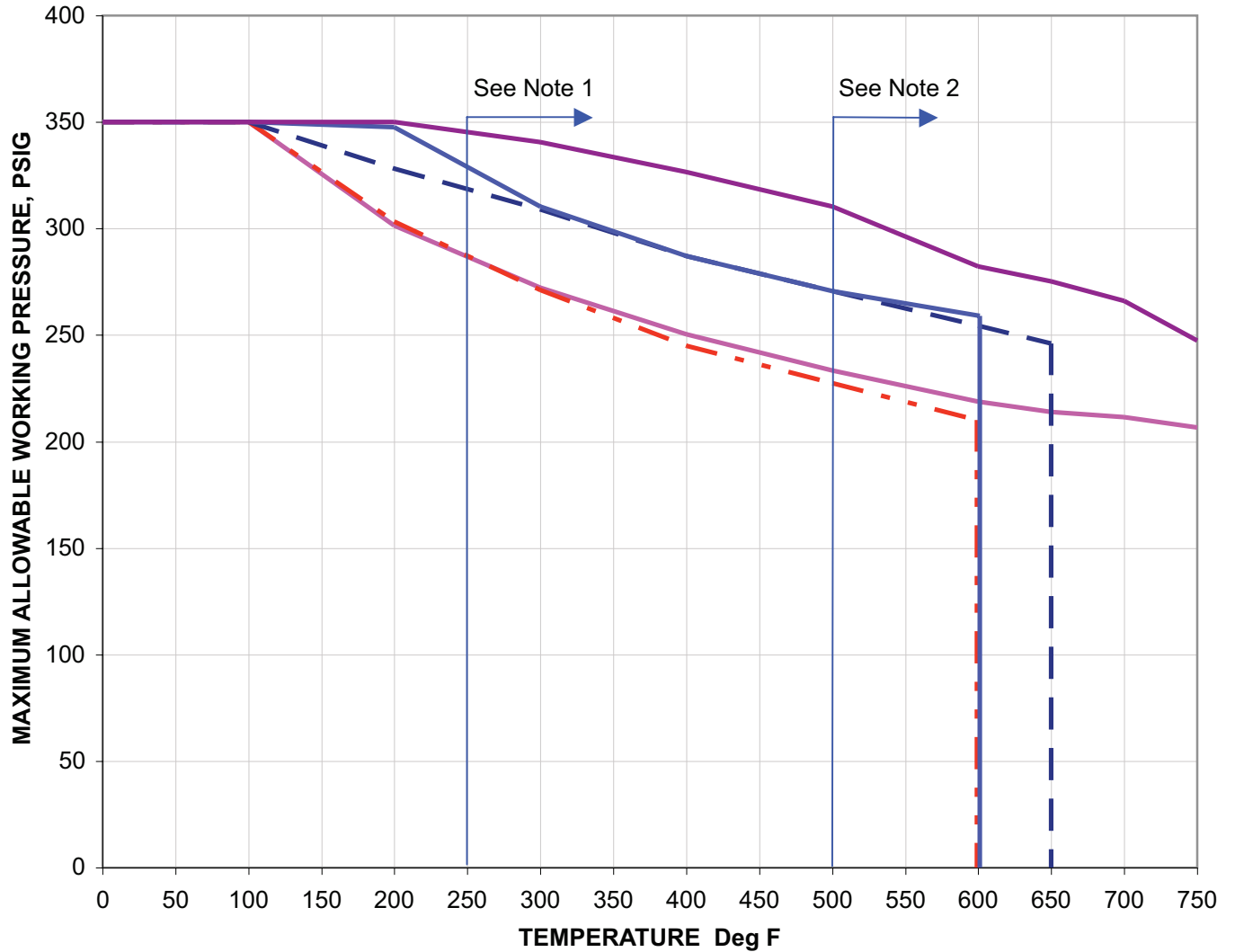

Notes:

- 1) Center Line Mount Only.
- 2) Frame A(excluding LD17) and Frame M units only.

Warning : A pump or pump component used under the jurisdiction of the ASME Boiler & Pressure Vessel Code, the ASME Code for Piping, or Governmental Regulations is subject to any limitation of that code or regulation. This may include maximum temperature and/or pressure limitations, rules governing use of material at low temperature and restrictions on fluids or gases permitted to be contained by the pump material. The limitations defined in the chart provide application guidelines only and offer no guarantee that all applicable codes and regulations are met in any given application.

Blackmer® Centrifugal | Metric Pressure/Temperature Limits

For Pumps with standard 150 lb. flanges (all sizes)

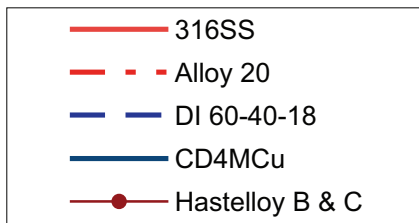
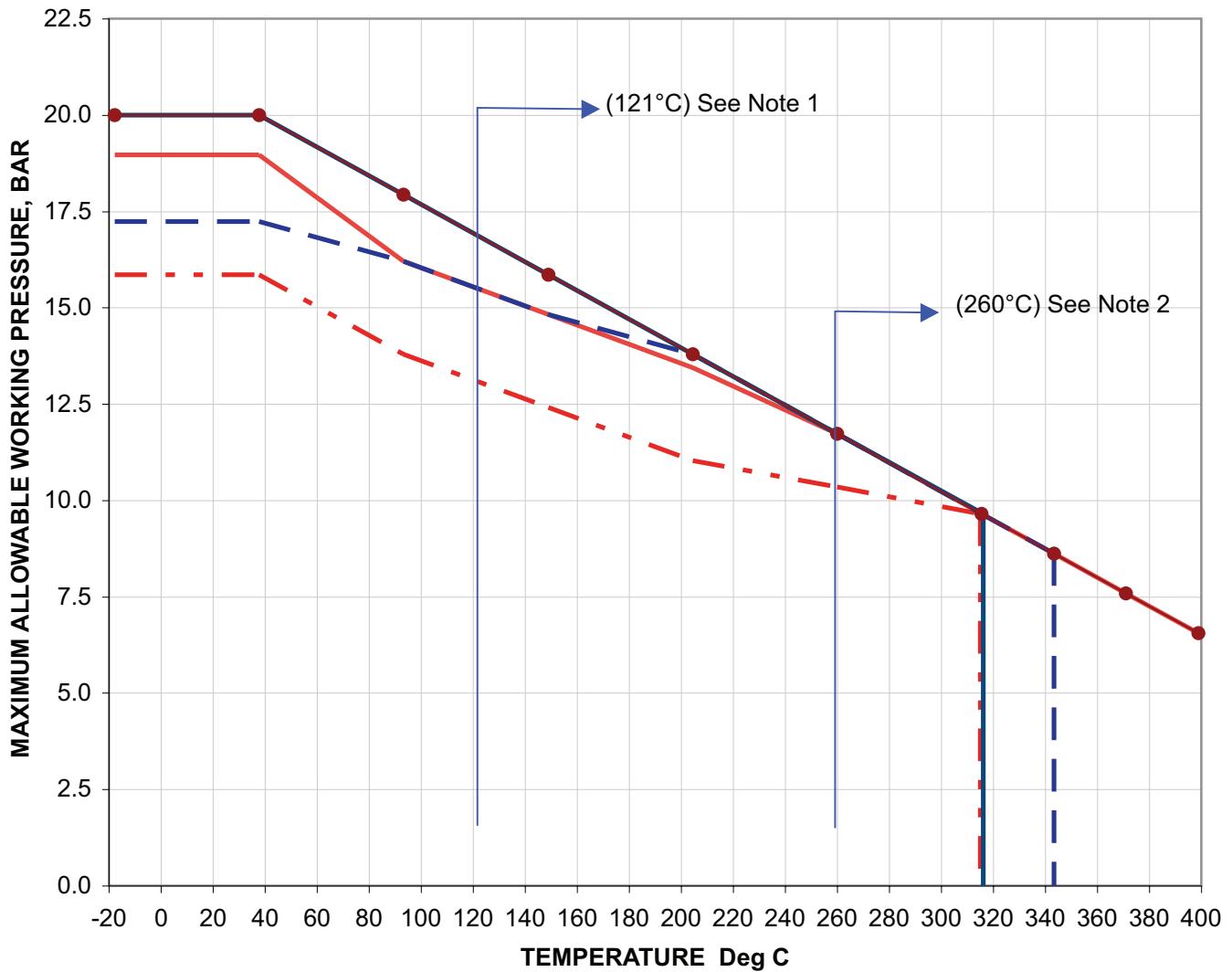

Notes:

- 1) Center Line Mount Only.
- 2) Frame A (excluding LD17) and Frame M units only.

Warning : A pump or pump component used under the jurisdiction of the ASME Boiler & Pressure Vessel Code, the ASME Code for Piping, or Governmental Regulations is subject to any limitation of that code or regulation. This may include maximum temperature and/or pressure limitations, rules governing use of material at low temperature and restrictions on fluids or gases permitted to be contained by the pump material. The limitations defined in the chart provide application guidelines only and offer no guarantee that all applicable codes and regulations are met in any given application.

Blackmer® Centrifugal | Metric Pressure/Temperature Limits

FRS 6", 8" & 10" with 300 lb. Flanges

FRA/LD17 6", 8" & 10" with 300 lb. Flanges

FRM 13" with 300 lb. Flanges

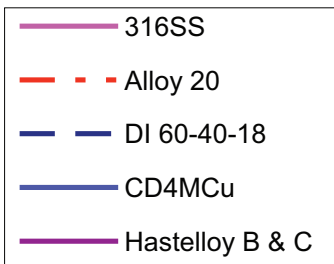
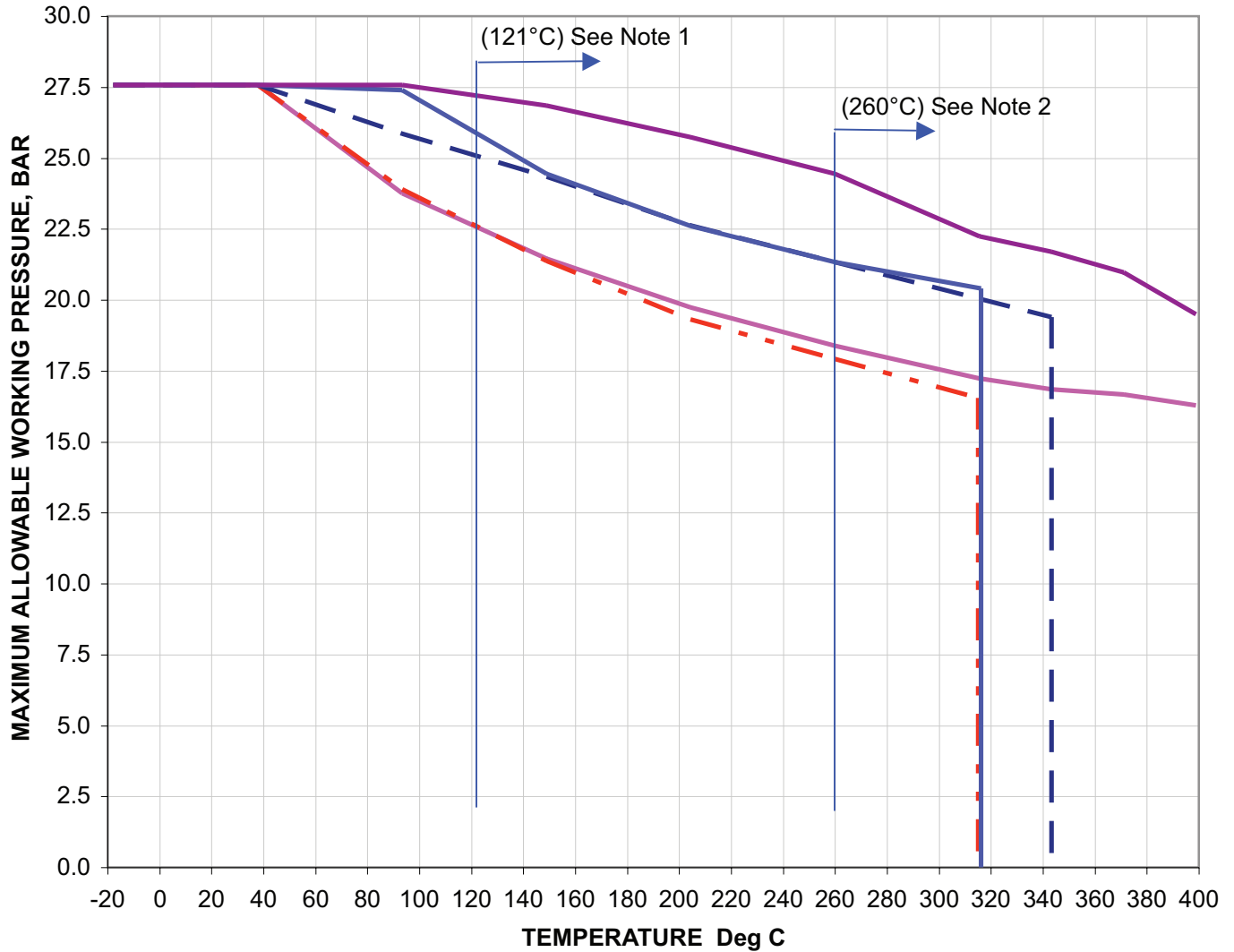

Notes:

- 1) Center Line Mount Only.
- 2) High Strength Bolting only.
- 3) Frame A(excluding LD17) and Frame M units only.

Warning: A pump or pump component used under the jurisdiction of the ASME Boiler & Pressure Vessel Code, the ASME Code for Piping, or Governmental Regulations is subject to any limitation of that code or regulation. This may include maximum temperature and/or pressure limitations, rules governing use of material at low temperature and restrictions on fluids or gases permitted to be contained by the pump material. The limitations defined in the chart provide application guidelines only and offer no guarantee that all applicable codes and regulations are met in any given application.

Blackmer® Centrifugal | Metric Pressure/Temperature Limits

FRA/LDI7 13" with 300 lb. Flanges

FRM 15" with 300 lb. Flanges

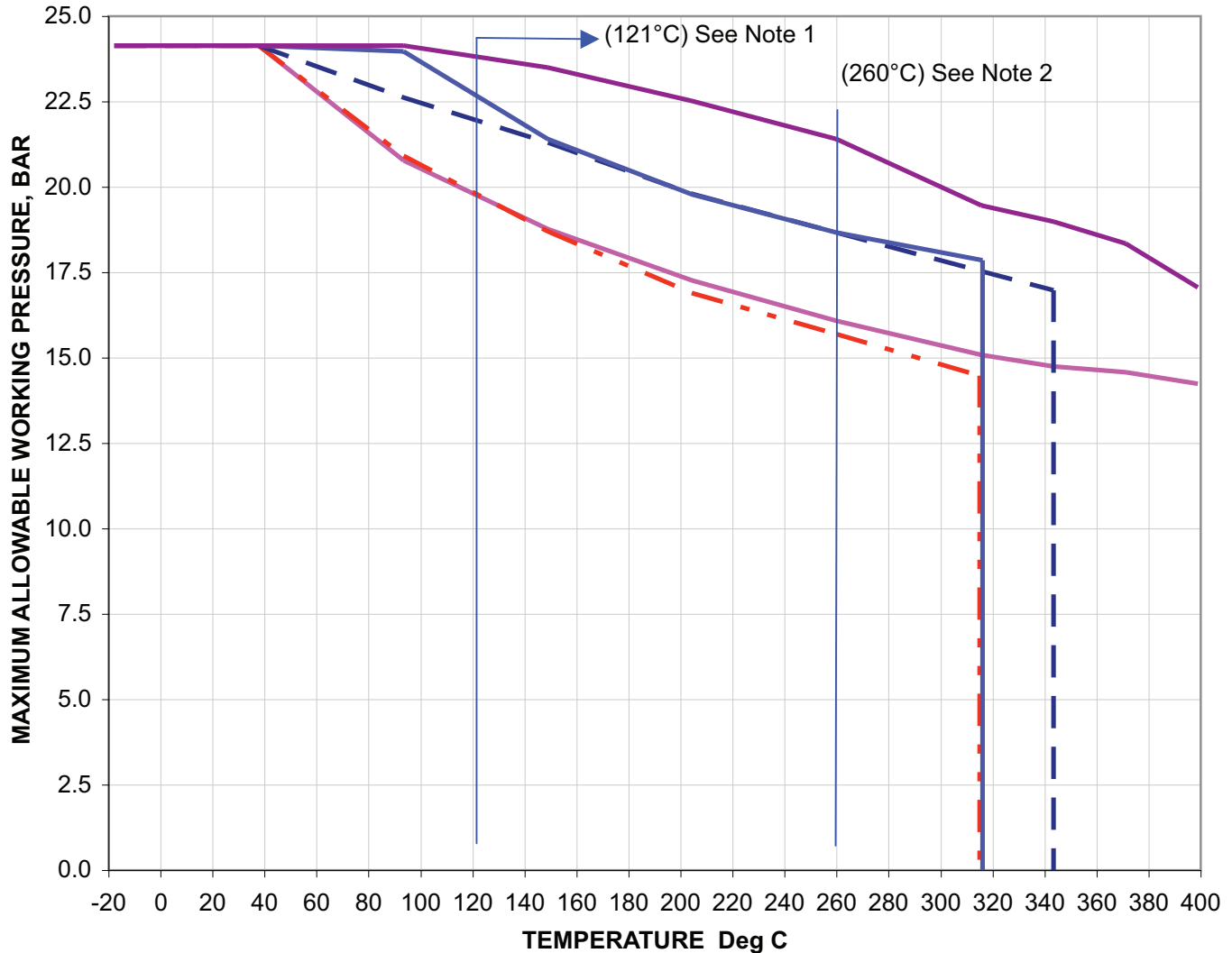

Notes:

- 1) Center Line Mount Only.
- 2) Frame A (excluding LD17) and Frame M units only.

Warning: A pump or pump component used under the jurisdiction of the ASME Boiler & Pressure Vessel Code, the ASME Code for Piping, or Governmental Regulations is subject to any limitation of that code or regulation. This may include maximum temperature and/or pressure limitations, rules governing use of material at low temperature and restrictions on fluids or gases permitted to be contained by the pump material. The limitations defined in the chart provide application guidelines only and offer no guarantee that all applicable codes and regulations are met in any given application.

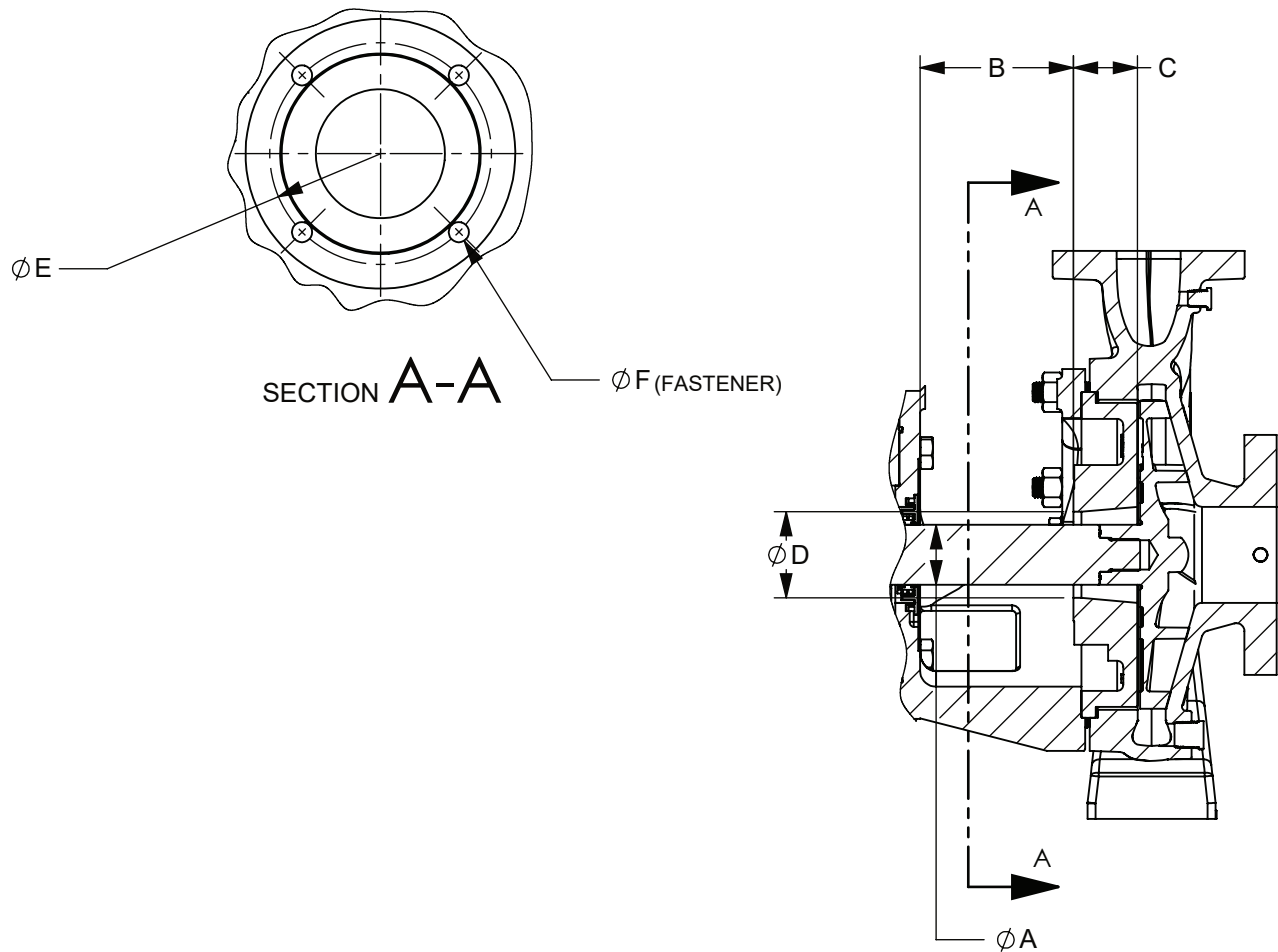

FRAME SIZE	SEAL CHAMBER ARRANGEMENT	UNITS	SHAFT SIZE Ø A	FIRST OBSTRUCTION DISTANCE B	AVAILABLE INBOARD LENGTH C	SEAL CHAMBER BORE Ø D	MOUNTING BOLT CIRCLE Ø E	MOUNTING BOLT HOLES Ø F
SD	BACK COVER/SEAL CHAMBER	IN	1.45	2.205	2.09	2.28	3.74	M10X1.5
		MM	38	56	53	58	95	
S	BACK COVER/SEAL CHAMBER	IN	1.500	2.38	2.21	2.38	3.50	3/8-16
		MM	38.1	60.45	56.13	60.45	88.9	
	BACK COVER/SEAL CHAMBER WITH JACKET	IN	1.500	2.38	2.12	2.30	3.50	
		MM	38.1	60.45	53.85	58.42	88.9	
A	BACK COVER/SEAL CHAMBER	IN	1.875	3.00	2.88	2.69	4.75	1/2-13
		MM	47.625	76.2	73.15	68.33	120.65	
M	BACK COVER/SEAL CHAMBER	IN	2.625	3.13	2.56	3.62	5.75	5/8-11
		MM	66.675	79.50	65.02	91.95	146.05	
		IN	2.625	3.13	3.56	3.62	5.75	
LD17	BACK COVER/SEAL CHAMBER WITH TAPER BORE	MM	66.675	79.50	90.42	91.95	146.05	
		IN	1.875	2.19	2.00	2.69	4.62	1/2-13
		MM	47.625	55.63	50.8	68.33	117.35	

Table of Contents:

- 1.0 Scope
- 2.0 General Pump Selection
- 3.0 Pump Specification
- 4.0 Paint Specification
- 5.0 Quotation Requirements
- 6.0 Documentation Requirements
- 7.0 Vendor Requirements
- 8.0 Blackmer Warranty Document

1.0 SCOPE

This specification applies to the selection and performance of centrifugal pumps. The intent of the specification is that the supplied equipment shall be designed to offer long service life, minimize life cycle cost and be easily installed and maintained.

2.0 PUMP SELECTION

2.1.1

The pumps for this project shall be selected to allow maximum interchangeability of parts without limiting pump performance. The rotating assembly/power end for each pump shall be interchangeable with all the pump wet ends selected, unless otherwise designated.

2.1.2

The pumps shall operate in accordance with the hydraulic performance requirements.

2.1.3

The pump shall operate smoothly throughout the entire design operating flow range or rpm range with low vibrations. Acceptable vibration limits shall be as specified in Hydraulic Institute Standards for Centrifugal Pumps.

2.1.4

The pump impeller shall provide the design head and flow rate as designated by the purchaser. The impeller diameter selected to meet design conditions shall not be smaller than the minimum as shown in the manufacturers published performance curves.

2.1.5

The pumps defined herein are for general/industrial/chemical process service. They shall be designed for continuous duty, with extended performance life and low maintenance and operations costs.

2.1.6

The pump shall be a back pull-out design with a radially split casing.

2.1.7

The noise level generated by the pump and motor shall not exceed 85 dB, or motor noise level plus 3 dB, when measured at a distance of 3 feet.

2.2.0

The pump suction and discharge flange arrangement shall conform to ANSI B73.1 (or DIN 16 bar standard where applicable).

2.2.1

Castings shall be sound and free of shrink holes, blow holes, scale, blisters and other obvious defects.

2.2.2

Pressure containing castings shall not be repaired by plugging, peening, burring in or impregnating.

2.2.3

The pump shall be permanently tagged with a 300 series stainless steel nameplate. Nameplate information shall include pump size, gpm, TDH, speed, material of construction, rated impeller diameter and serial number. An arrow shall appear on the pump clearly showing the direction of rotation.

2.2.4

Casing discharge shall be centerline discharge unless otherwise specified. Side discharge to be an available option.

2.2.5

Pump shall be selected based on minimizing life cycle costs and emissions, not on minimizing initial purchase costs. Proposed selection will be based on rotor dynamics evaluation, hydraulic performance and effective window of operation. Debits/credits will be used to evaluate vendor proposals.

2.2.6

The pump casing shall incorporate centerline support feet for design operating temperatures above 250°F (120°C).

3.0 PUMP SPECIFICATION

The pump shall be horizontal end suction, in accordance with the following specification.

3.1.1 CASING

The pump casing shall be constructed of ductile iron, 316 SS, CD4MCU, Alloy 20, or other material as required by the application. The casing for pump sizes 4 x 6-13 (100 x 150-330) and below (ANSI designation A80) shall be single volute design, with the discharge flange located on the vertical centerline of the casing, and meet ANSI B73.1 specifications and dimensions. For all sizes above A80, double volute construction is required.

Centerline mounted casing feet are required for all applications over 250°F (120°C), on medium and large frame pumps. The casing is to be supported on two (2) separate legs; made of ductile iron or carbon steel, to prevent misalignment of the pump rotating element within the pump casing at elevated temperatures.

The casing suction and discharge nozzles shall have flat faced, 150 lb., 300 lb., or 16 bar flanges as required by the application. The casing shall be capable of accepting full API 610 suction and discharge nozzle loading.

The suction and discharge neck shall be drilled and tapped with 1/4" NPT connections, for pressure gauges and/or auxiliary piping. The casing wall thickness will include 1/8" corrosion allowance. A rotation arrow will be cast on the surface of the casing to indicate the proper direction of rotation.

3.1.2 IMPELLER

The impeller shall be open type, cast in CD4MCU or material as required by the application. Repelling vanes shall be cast on the back side of the impeller, to reduce the pressure behind the impeller in the immediate area of the mechanical seal and/or packing chamber.

The impeller hubs shall incorporate a threaded fit to the pump shaft. The impeller threads shall be sealed from corrosive environment by a PTFE O-ring in the hub.

Open impellers are preferred.

The impeller shall be balanced to ISO specification G.6.3 or better unless otherwise specified.

Balancing must be performed in a minimum of two planes. Balancing shall, unless detrimental to the component or its performance, be attained by the removal of material.

3.1.3 SHAFT

The pump shaft shall be constructed of solid 316SS, 17-4PH, or as required by the application. Bimetallic shafts are acceptable. Shaft sleeves are not acceptable. The pump shaft shall be mechanically non-contacting throughout the entire rotating element, with the exception of the ball bearings, to prevent wear at the bearing oil seal and mechanical seal. The stiffness ratios (L^3/D^4), where L= length of shaft from impeller centerline to nearest bearing in inches and D= shaft diameter under the seal in inches, shall not exceed the following values in order to establish satisfactory mechanical seal life.

Shaft size at seal	L^3/D^4
• Shafts $\leq 1.5''$	46 (1.9)
• Shafts $> 1.5''$, $\leq 2.0''$	20 (0.8)
• Shafts $> 1.5''$, $\leq 2.0''$ ¹	551 (2.1)
• Shafts $> 2''$	19 (0.7)

¹special requirements

3.1.4 THRUST AND RADIAL BEARINGS

The pumps shall be fitted with the following bearings:

Small Frame Pumps (ANSI AA through A50):

The thrust bearing shall be at a minimum a 5308, AHC3 clearance, double row, deep groove bearing. A pair of 7308 BEGAY, back to back angular contact bearings shall be provided as an option when required. The radial bearing shall be at least a 6308, C3 clearance, single row, deep groove.

Medium Frame Pumps (ANSI A60 through A80):

The thrust bearing shall be at a minimum a pair of 7310 BEGAY clearance, back to back angular contact bearings.

The radial bearing shall be at least a 6310 C3 clearance, single row, deep groove.

Large Frame Pumps (ANSI A90 through A120):

The thrust bearing shall be at a minimum a pair of 7314 BEGAY clearance, back to back angular contact bearings.

The radial bearing shall be at least 6314 C3 clearance single row, deep groove.

The thrust and radial bearings shall be fitted to the shaft based on SKF tolerance specifications. The method of lubrication shall be oil bath for horizontals and grease for verticals. The thrust bearings shall be locked into the cartridge by a bolt-on retainer cover. Snap ring bearing retainers are not acceptable. The radial bearing shall be permitted to slide within the inside diameter of the bearing frame to prevent axial load and permit radial load only. Double row filled slot bearings are not acceptable. Bearings shall be designed for a minimum L-10 life of 60,000 hours.

3.1.5 BEARING FRAME

The bearing frame shall be heavy-duty cast iron construction, with radial fins for maximum cooling. The oil sump shall contain a minimum of 8 ounces (.23L) of oil for small frame pumps, 24 ounces (.71L) of oil for mid-frames and 32 ounces (.94L) of oil for large frames to allow for more heat dissipation, better lubrication and a cooler running rotating element. The oil level within the bearing frame shall be monitored by an oil sight glass. The level shall not exceed the bearing lower ball centerline for both the thrust and radial bearings in order to provide ample lubrication and heat dissipation. The oil sight glass shall have a white color perforated background to permit visual inspection of the condition of the oil and also permit circulation of oil in the sight glass to keep the interior surface of the glass clean. An oil drain plug is required at the bottom of the bearing frame. Two (2) magnetic pipe plugs shall be located near the bottom of the bearing frame. The oil fill fitting at the top shall be of nylon with an easily removable cap for adding oil. Trico or bottle type constant level oilers are not acceptable.

3.1.6 BEARING OIL SEALS

Each end of the bearing frame assembly shall incorporate non-contacting labyrinth oil seals. This type of seal is required to eliminate shaft damage due to fretting and to eliminate the heat generated by the use of contact type lip seals. Materials of construction shall be nickel plated (or built in cast iron) stators and 316SS rotors. Other seal systems will be considered only if they are non-fretting. Shaft contacting type lip seals will not be accepted. Face type oil seals are to be available for severe applications where specified.

3.1.7 FRAME ADAPTER

The frame adapter shall be designed to maintain accurate alignment of the bearing frame and rotating element to the wet end and allow proper access to the mechanical seal and environmental seal control piping. The frame adapter shall use a machined rabbit type fit to align with the bearing frame and pump casing.

3.2.0 MECHANICAL SEAL CHAMBER

The back cover and seal chamber shall be of ductile iron, 316 SS, CD4MCU, Alloy 20, or other material as required by the application.

A corrosion allowance of 1/8" (3 mm) is required. The back cover shall be fastened to the pump casing with a confined type gasket.

The pump shall incorporate a large bore seal chamber. The seal chamber shall be designed with a minimum radial clearance of at least 0.75 inches (19 mm). This will result in improved cooling,

cleaning, lubricating and circulation to prolong the life of the mechanical seal. The chamber shall have an optional tangential flush connection on the side to flush the mechanical seal, and provide maximum cleaning capability. The seal chamber shall be capable of incorporating a jacket (when required) for cooling on high temperature applications or steam heating of liquids that tend to congeal in the seal chamber. Taper bore seal chambers shall have a minimum taper of 4° and a maximum radial clearance of 0.625 inches (16 mm) where abrasive solids are present to minimize rotation. Deep taper bore seal chambers must include vortex breakers and are not acceptable in abrasive applications.

3.2.1 CENTERLINE SUPPORT LEGS and POWER END FOOT

All Mid-frame and Large-frame pumps operating above 250°F (120°C) shall be supplied with adjustable centerline casing support legs. These feet will be affixed to the volute at the horizontal centerline of the volute. Small-frame pumps, when specified for applications above 200°F (94°C), must allow unrestricted casing thermal growth. A casing without feet (frame mounted pump) is required for these applications.

Small frame and medium frame pumps shall have a bearing frame foot that will support the power end in an upright position when removed from the wet end for service. The bearing frame foot may be height adjustable, if possible, to allow for ease of alignment.

3.2.2 IMPELLER CLEARANCE ADJUSTMENT

The thrust bearing end of the bearing frame shall be capable of precision impeller adjustments without the need to add or remove shims. The minimum delineation shall be .003" (.08mm) and permit impeller clearance settings or readjustments without the need to remove the bearing frame from the volute section and without requiring shims, dial indicators, feeler gauges or disassembly.

3.2.3 BACK PULL-OUT FEATURE

The pump shall permit the removal of the entire bearing frame assembly, including shaft, mechanical seal or packing chamber, and impeller, without disturbing the pump discharge and suction piping and without disturbing the motor. A spacer type coupling shall be furnished on non-motor adapter pumps to allow removal of the power end without disturbing the motor.

3.2.4 C- FRAME OR D-FLANGE MOTOR ADAPTERS

The pump shall have the capability of incorporating a C-Frame motor adapter, which permits mounting of motors up to NEMA frame size 256TC (IEC 132) for small frame, 405TC (447TSC) (IEC 180) for medium frame, and 449T(S)C (IEC 180) for large frame, without the need for parallel and angular alignment measurements and adjustments. The motor adapter may be equipped with adjustable feet in order to avoid frame soft foot and eliminate the need to use shims under the adapter assembly.

3.2.5 WARRANTY

The pump shall be warranted for a period of one (1) year from the date of installation, but not to exceed eighteen (18) months after the date of shipment to the user, to be free of defects in material and workmanship. In addition the following warranty, exclusive of erosion and corrosion, is required:

- Should the mechanical seal fail within one year of the original pump and seal installation, a rebuild kit or a rebuilt seal will be provided at no charge.
- If the mechanical seal causes shaft fretting damage that minimizes or eliminates sealing capability, a new replacement seal and/or shaft will be provided.
- Should any power end component, including bearings, fail within five (5) years of the original installation, a free replacement component will be provided.

4.0 PUMP PAINT SELECTION

Surface preparation:

Parts are cleaned in an industrial washer with appropriate cleaner.

All parts are then rinsed in a rinse tank.

Paint:

One coat of Rustoleum "High Performance Epoxy 9100 Series System" Yellow #A91-4412 base with A5275 activator or equivalent epoxy coat system.

This product is a two component, high build, polyamide / amine-modified low VOC epoxy coating.

Total Paint Thickness:

Dry film thickness range of epoxy coating shall be .005" to .008" (0.12- 0.20 mm).

Total Paint Thickness:

Dry film thickness range of epoxy coating shall be .005" to .008".

5.0 QUOTATION REQUIREMENTS

5.1.1

Quotation shall be completed in strict accordance with the requisition requirement.

5.1.2

Vendor shall state all exceptions to this specification in the bid package. All deviations and/or exceptions from this specification must be outlined in full detail and the reasons for these exceptions fully explained.

5.1.3

Unless the vendors proposal takes exception as outlined in the section above (5.1.2) conformance is implied and assumed. Alternates and exceptions shall be clearly defined and described in the vendors proposal.

5.1.4

Alternates may be submitted with the bid. They shall be clearly described and defined in the vendors proposal.

5.1.5

The proposal shall include a Pump Performance Curve showing gpm, TDH, NPSHR, Efficiency, Power requirements @ design and runout, and design and maximum/minimum impeller. Also included shall be shaft stiffness ratios and descriptive literature for the pump and the mechanical seal.

5.1.6

The quotation shall include a complete list of recommended spare parts with price and delivery information.

6.0 DOCUMENTATION REQUIREMENTS

Within ten (10) working days after the purchase order is received the vendor will supply the following:

- | | |
|--------------------------------------|----------|
| A) Dimensional Prints | () Copy |
| B) Parts List | () Copy |
| C) Operation and Installation Manual | () Copy |
| D) Certified Performance Curve | () Copy |
| E) Mechanical Seal Drawing | () Copy |

7.0 VENDOR REQUIREMENTS

The vendor shall have the capability of flying spare parts to any location within a 24 hour period. All applicable spare parts must be available from the plant within this time period.

Service capabilities will include start-up, troubleshooting and personnel training by a vendor authorized representative.

Blackmer® Centrifugal Pump Warranty

For Frame: S, A, LD, and M Pumps

PRODUCT WARRANTY

Blackmer / A Dover Company warrants its products free from defects in materials and workmanship under normal use and service for which its products were designed. This warranty is for a period of 12 months after installation or 18 months after shipment from the factory, whichever comes first. If its products should fail through defect in workmanship or material within the warranty period, Blackmer must be notified in writing within the warranty period of such defects and shall have the option of requiring return of parts or product to its factory for verification of any claim.

The warranty is in lieu of any other liability for defects. BLACKMER MAKES NO WARRANTY OF MERCHANTABILITY AND NO WARRANTY THAT ITS PRODUCTS SHALL BE APPROPRIATE FOR ANY PARTICULAR PURPOSE, nor are there any other warranties, expressed or implied, by operation of law or otherwise. This warranty does not cover any expense (labor, lost production, travel expense, etc), incurred in repairs or alteration made outside the Blackmer factory without prior authorization, nor does it cover in any way the performance of equipment which has been revised or altered by others. The customer is wholly responsible for establishing the suitability of the product for his particular application and for operating conditions, which do not exceed published product limitations. Blackmer shall not be liable for damages or delay resulting from or related to defective products, nor for consequential, special or contingent damages for breach of warranty.

Product returns must be processed by an authorized Blackmer representative. The guide for Product Return For Warranty Inspection as defined in BLACKMER's GENERAL SALES POLICY (page 001-001 or 001-001a) must be adhered to.

POWER END - FIVE YEAR PERFORMANCE ASSURANCE

Should any power end component fail within 5 years of the original installation, including bearings or shafts that have fractured, a free replacement component will be provided.

This offer is limited to a claim for one of each component per power end

MECHANICAL SEALS - ONE YEAR PERFORMANCE ASSURANCE

Should any factory supplied and installed mechanical seal fail within one year after the sale of the pump and seal, a spare parts kit (with materials the same as the original seal) will be provided at no charge.

Program includes power end conversions that were purchased with Blackmer back cover conversions.

Limit of one seal claim per application.

LIMITATION OF LIABILITY

Blackmer's obligation under the warranty is expressly limited to replacing defective seals or parts of the seal and/or power end. In no event will Blackmer be liable for labor, lost production, damage or loss to persons or property, or consequential damages.

The warranty for shafts covers a shaft failure due to breakage or fretting caused by the factory installed mechanical seal. Any other type of surface damage (corrosion, erosion, damaged keyway or bending of the shaft) will not be covered.

Damage to shafts, labyrinth seals or wet end components as a result of a bearing failure are not covered under the warranty program.

The warranty covers replacement of the failed bearing only. The other bearing or entire rotating element is not included.

This warranty excludes coverage for erosion and corrosion. Pumps and seals must be installed, operated, and maintained within Blackmer Centrifugal Pump specifications and design parameters. An authorized Blackmer representative must approve applications including environmental controls. Warranty exceptions are intentional or gross misuse. For the extended warranty to be valid, a Pump Information Form for Serial Number Assignment must be supplied to Blackmer prior to shipment for all complete pump orders and power end orders.



PSG Grand Rapids
1809 Century Avenue SW
Grand Rapids, MI 49503-1530
USA
P: +1 (616) 241-1611
F: +1 (616) 241-3752
info@blackmer.com
blackmer.com



Where Innovation Flows

1301-001 09/21

Authorized PSG® Partner:

Copyright 2022 PSG®, a Dover company