

BLACKMER POWER PUMPS

INSTALLATION OPERATION AND MAINTENANCE INSTRUCTIONS MODELS: HXL6G, HXL8G, HXLJ8G, HXL10E

960229

INSTRUCTIONS NO. 102-A00

Section
Effective
Replaces

102
Jun 2020
Jan 2014



SAFETY DATA



This is a SAFETY ALERT SYMBOL.

When you see this symbol on the product, or in the manual, look for one of the following signal words and be alert to the potential for personal injury, death or major property damage



Warns of hazards that **WILL** cause serious personal injury, death or major property damage.



Warns of hazards that **CAN** cause serious personal injury, death or major property damage.



Warns of hazards that **CAN** cause personal injury or property damage.

NOTICE:

Indicates special instructions which are very important and must be followed.

NOTICE:

Blackmer Power Pumps **MUST** only be installed in systems, which have been designed by qualified engineering personnel. The system **MUST** conform to all applicable local and national regulations and safety standards.

This manual is intended to assist in the installation and operation of Blackmer Power pumps, and **MUST** be kept with the pump.

Pump service shall be performed by qualified technicians **ONLY**. Service shall conform to all applicable local and national regulations and safety standards.

Thoroughly review this manual, all instructions and hazard warnings, **BEFORE** performing any work on the pump.

Maintain **ALL** system and pump operation and hazard warning decals.

TABLE OF CONTENTS

Page

PUMP DATA	
Technical Data	2
Initial Pump Start Up Information.....	2
INSTALLATION	
Pre-Installation Cleaning	3
Location and Piping.....	3
Pump Mounting	3
Coupling Alignment	4
Pump Rotation	4
To Change Pump Rotation.....	4
Check Valves	4
Manual Bypass Valves.....	4
OPERATION	
Pre-Start Up Check List.....	5
Start Up Procedures.....	5
Running the Pump in Reverse Rotation	5
Flushing the Pump	6
Pump Relief Valve.....	6
Relief Valve Setting and Adjustment	6
MAINTENANCE	
Torque Table.....	7
Scheduled Maintenance.....	7
Strainers	7
Lubrication.....	7
Vane Replacement.....	8
Pump Disassembly (HXL6 and HXLJ8).....	9
Pump Assembly (HXL6 and HXLJ8)	9
Pump Disassembly (HXL8 and HXL10)	11
Pump Assembly (HXL8 and HXL10).....	12
TROUBLE SHOOTING	14

Numbers in parentheses following individual parts indicate reference numbers on the Blackmer Parts List for the pump being serviced.

PUMP PARTS LISTS

HXL6	HXL8, HXLJ8	HXL10
102-A01	102-A02	102-A04

Blackmer pump manuals and parts lists may be obtained from Blackmer's website (www.blackmer.com) or by contacting Blackmer Customer Service.

SAFETY DATA

⚠ WARNING



Hazardous pressure can cause personal injury or property damage

Disconnecting fluid or pressure containment components during pump operation can cause serious personal injury, death or major property damage

⚠ WARNING



Hazardous voltage. Can shock, burn or cause death.

Failure to disconnect and lockout electrical power before attempting maintenance can cause shock, burns or death

⚠ WARNING



Hazardous machinery can cause serious personal injury.

Failure to disconnect and lockout electrical power or engine drive before attempting maintenance can cause severe personal injury or death

⚠ WARNING



Do not operate without guard in place

Operation without guards in place can cause serious personal injury, major property damage, or death.

⚠ WARNING



Hazardous or toxic fluids can cause serious injury.

If pumping hazardous or toxic fluids, system must be flushed and decontaminated, inside and out, prior to performing service or maintenance

⚠ WARNING



Hazardous pressure can cause serious personal injury or property damage

Failure to relieve system pressure prior to performing pump service or maintenance can cause serious personal injury or property damage.

⚠ CAUTION



Heavy assemblies can cause personal injury or property damage.

Always use a lifting device capable of supporting the full weight of the pump assemblies.

PUMP DATA

PUMP IDENTIFICATION

A pump Identification tag, containing the pump serial number, I.D. number, and model designation, is attached to each pump. It is recommended that the data from this tag be recorded and filed for future reference. If replacement parts are needed, or if information pertaining to the pump is required, this data must be furnished to a Blackmer representative.

TECHNICAL DATA *

	HXL6G	HXL8G HXLJ8G	HXL10E
Maximum Pump Speed	350 RPM	350 RPM	230 RPM
Maximum Operating Temperature	300°F (149°C)	300°F (149°C)	300°F (149°C)
Maximum Differential Pressure	125 psi (8.6 Bar)	150 psi (10.3 Bar)	150 psi (10.3 Bar)
Maximum Working Pressure	150 psi (10.3 Bar)	250 psi (17.2 Bar)	250 psi (17.2 Bar)

INITIAL PUMP START UP INFORMATION

Model No.	_____
Serial No.	_____
ID No.	_____
Date of Installation:	_____
Inlet Gauge Reading:	_____
Discharge Gauge Reading:	_____
Flow Rate:	_____

* Technical Data is for standard materials of construction. Consult Blackmer Material Specs for optional materials of construction.

INSTALLATION

NOTICE:

Blackmer power pumps must only be installed in systems designed by qualified engineering personnel. System design must conform with all applicable regulations and codes and provide warning of all system hazards.



- ⚠️ Install, ground and wire to local and National Electrical Code requirements.
- ⚠️ Install an all-leg disconnect switch near the unit motor.
- ⚠️ Disconnect and lockout electrical power before installation or service
- ⚠️ Electrical supply **MUST** match motor nameplate specifications.

⚠️ Motors equipped with thermal protection automatically disconnect motor electrical circuit when overload exists. Motor can start unexpectedly and without warning.

PRE-INSTALLATION CLEANING

NOTICE:

New pumps contain residual test fluid and rust inhibitor. If necessary, flush pump prior to use.

Foreign matter entering the pump WILL cause extensive damage. The supply tank and intake piping **MUST** be cleaned and flushed prior to pump installation and operation.

LOCATION AND PIPING

An improperly designed piping system or improper unit installation WILL significantly reduce pump performance and life. Blackmer recommends the following piping system layout and unit installation.

1. To minimize intake losses, locate the pump as close as possible to the source of supply.
2. Intake piping and fittings **MUST** be at least as large in diameter as the pump intake connection.
3. Minimize the number of intake line fittings (valves, elbows, etc.) and piping turns or bends. When used, intake fittings must be located at least 5 - 10 pipe diameters from the pump intake.
4. Install an intake strainer 5 - 10 pipe diameters from the pump intake. For viscosities less than 1000 SSU, the strainer should have a net open area of at least four times the area of the intake pipe. For viscosities greater than 1000 SSU, consult the strainer manufacturer instructions.
5. Strainers must be cleaned regularly to avoid pump starvation.
6. Intake and discharge piping **MUST** be free of all leaks.
7. Expansion joints, placed at least 36" (0.9m) from the pump, will compensate for expansion and contraction of the pipes. Contact the flexible connector/hose manufacturer for required maintenance/care and design assistance in their use.
8. Install pressure gauges in the NPT ports provided in the pump casing to check pump at start up.

9. ALL piping and fittings **MUST** be properly supported to prevent any piping loads from being placed on the pump.
10. Check alignment of pipes to pump to avoid strains which might later cause misalignment. See Figure 1. Unbolt flanges or break union joints. Pipes should not spring away or drop down. After pump has been in operation for a week or two, completely recheck alignment.

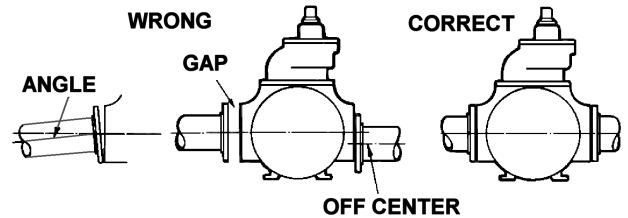

Figure 1

11. When pumping liquids at elevated temperature, provisions should be made to compensate for expansion and contraction of the pipes, especially when long pipe lines are necessary. Steel pipe expands approximately 3/4" (1.9 cm) per 100 feet (30.49 m) per 100°F (37.8°C) rise in temperature.

PUMP MOUNTING

It is recommended the unit be permanently mounted by securing the base plate with adequately sized anchor bolts to a level concrete floor following recommended industry standards. A solid foundation will reduce system noise and vibration, and will improve pump performance. Refer to ANSI/HI standards or a suitable pump handbook for information on typical pump mounting and foundations. Check coupling alignment after pump and base assembly is secured to the foundation.

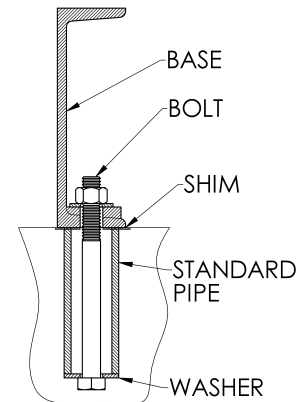

Figure 2 - Pipe Type Anchor Bolt Box

When installing units built on channel or structural steel type bases, use care to avoid twisting the base out of shape when anchor bolts are tightened. Shims should be used under the edges of the base prior to tightening of the anchor bolts to prevent distortion.

INSTALLATION

COUPLING ALIGNMENT

The pump must be directly coupled to a gear and/or driver with a flexible coupling. Verify coupling alignment after installation of new or rebuilt pumps. Both angular and parallel coupling alignment **MUST** be maintained between the pump, gear, motor, etc. in accordance with manufacturer's instructions. See Figure 3.

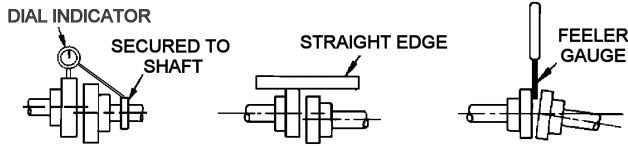
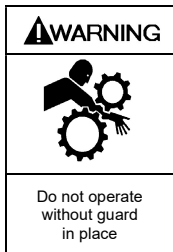

Figure 3 – Alignment Check

1. Parallel alignment: The use of a laser alignment tool or dial indicator is preferred. If a laser alignment tool or dial indicator is not available, use a straightedge. Turn both shafts by hand, checking the reading through one complete revolution. Maximum offset should be less than .005" (0.127 mm).
2. Angular alignment: Insert a feeler gauge between the coupling halves. Check the spacing at 90° increments around the coupling (four check points). Maximum variation should not exceed .005" (125 microns). Some laser alignment tools will check angular alignment as well.



Operation without guards in place can cause serious personal injury, major property damage, or death.

PUMP ROTATION

To determine pump rotation:

If the intake port is on the right, with the drive end of the shaft pointing towards the observer, the pump is **right-hand**, or **CLOCKWISE** rotation.

If the intake is on the left, with the drive end of the shaft pointing towards the observer, the pump is **left-hand**, or **COUNTERCLOCKWISE** rotation.

NOTICE:

Confirm correct pump rotation by checking the pump rotation arrows respective to pump driver rotation.

TO CHANGE PUMP ROTATION

The vanes (14) must be reversed so that the relief grooves face in the direction of rotation. On HXL10, HXL8 and HXLJ8 models, reverse the liner (41). If equipped with a pump mounted relief valve, it must also be reversed (see Figure 4). Refer to "Pump Disassembly" and "Pump Assembly" sections of this manual for parts removal and replacement instructions.

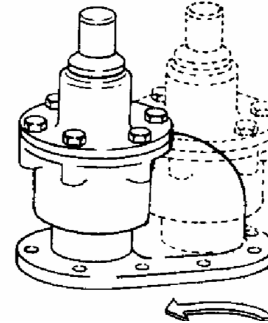

Figure 4 – Reversing the Relief Valve

CHECK VALVES

If a check valve is used, install it at the pump discharge. The use of check valves or foot valves in the supply tank is not recommended with self-priming, positive displacement pumps.

If the possibility of liquid backflow exists when the pump is off, a check valve in the pump discharge piping is recommended because the pump can motor in the reverse rotation and create undue stress on all attached components. Never start a pump when it is rotating in the reverse rotation as the added starting torque can damage the pump and related equipment.

MANUAL BYPASS VALVES

A bypass line from the pump discharge to the pump suction with a manual shut-off valve is recommended when handling volatile or viscous liquids at a high lift, or when delivering to piping too small to take the full flow from the pump.

The following size of manual bypass valve and recirculating lines are normally recommended:

6" pump	2" valve and piping
8" pump	3" valve and piping
10" pump	4" valve and piping

When handling very viscous liquids, excessive pressures may develop when starting the system. To avoid possible damage to the pump, open the manual bypass valve before starting. After the pressure stabilizes and the pump is running smoothly, close the valve slowly to increase the flow through the system until maximum acceptable system performance is attained.

As heavy liquids with "light ends" are heated to a higher temperature to lower the viscosity, the amount of volatile product given off is increased. The resulting cavitation may cause the pump to become noisy and begin vibrating. By cracking the manual bypass valve open and permitting some of the liquid to recirculate back to the pump inlet pipe or to the supply tank, the noise and vibration can be reduced to an acceptable level. If the pump noise and vibration cannot be controlled with the manual bypass valve, look for other causes of noise in the "Troubleshooting" section of this manual.

OPERATION

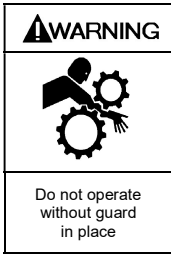

Operation without guards in place can cause serious personal injury, major property damage, or death.

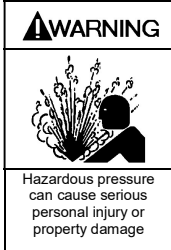

Disconnecting fluid or pressure containment components during pump operation can cause serious personal injury, death or major property damage

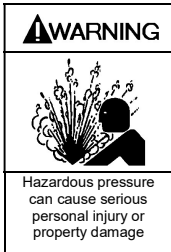

Failure to relieve system pressure prior to performing pump service or maintenance can cause serious personal injury or property damage.

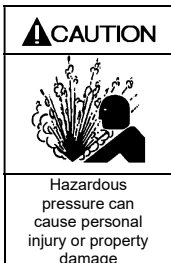

Pumps operating against a closed valve can cause system failure, personal injury and property damage

PRE-START UP CHECK LIST

1. Check the alignment of the pipes to the pump. Pipes should be supported so that they do not spring away or drop down when pump flanges or union joints are disconnected.
2. Verify proper coupling alignment.
3. Install pressure gauges in the 1/4" NPT intake and discharge ports located on the pump casing to check pump performance after start-up.
4. Ensure all valves and fittings in piping system are in the start-up or operating positions.
5. Check the wiring of the pump motor and jog the pump motor to verify proper pump rotation.

START UP PROCEDURES

NOTICE:

Consult the "General Pump Troubleshooting" section of this manual if difficulties during start up are experienced.

1. Start the motor. Priming should occur within one minute.
2. Check the inlet and discharge pressure gauges to ensure the system is operating within expected parameters. Record the gauge readings in the "Initial Start Up Information" section of this manual.
3. Inspect piping, fittings, and associated system equipment for leaks, noise, vibration and overheating.
4. Check the flow rate to ensure the pump is operating within the expected parameters. Record flow rate in the "Initial Start Up Information" section.
5. Check the pressure setting of the relief valve by momentarily closing a valve in the discharge line and reading the pressure gauge. This pressure should be 10 -20 psi (0.7-1.4 bar) higher than the maximum system operating pressure, or the external system pressure control valve setting (if equipped). **DO NOT operate the pump against a closed discharge valve for more than 15 seconds.** If adjustments are needed, refer to the "Relief Valve Setting and Adjustment" section of this manual.

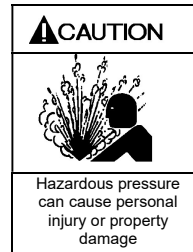

Incorrect settings of the pressure relief valve can cause pump component failure, personal injury, and property damage.

RUNNING THE PUMP IN REVERSE ROTATION

NOTICE:

Pump should be operated in reverse rotation for no more than 10 minutes and only when a separate pressure relief valve is installed to protect the pump from excessive pressure.

It may be desirable to run the pump in reverse rotation for system maintenance. The pump will operate satisfactorily in reverse rotation for a LIMITED time, at a reduced performance level.

OPERATION

HEATING HEADS / JACKETS (HXLJ8G)

NOTICE:

Maximum recommended heating jacket steam pressure is 150 PSI (10.3 bar).

Jacketed heads are recommended for heating highly viscous liquids, or to “thaw out” liquids that have congealed in the pumping chamber and packing area.

Hot oil or steam can be circulated through the jacketed heads by 1” NPT connections above and below the shaft.



Pumps fitted with heating devices have hot surfaces that can cause serious personal injury.

FLUSHING THE PUMP

NOTICE:

If flushing fluid is to be left in the pump for an extended time, it must be a lubricating, non-corrosive fluid. If a corrosive or non-lubricating fluid is used, it must be flushed from the pump immediately.

1. To flush the pump, run the pump with the discharge valve open and the intake valve closed. Bleed air into the pump through the intake gauge plug hole or through a larger auxiliary fitting in the intake piping. Pump air for 30 second intervals to clean out most of the pumpage.
2. Run a system compatible flushing fluid through the pump for one minute to clear out the remainder of the original pumpage.
3. To remove the flushing fluid, follow step 1 above.

NOTICE:

After flushing the pump some residual fluid will remain in the pump and piping.

NOTICE:

Properly dispose of all waste fluids in accordance with the appropriate codes and regulations.

PUMP RELIEF VALVE

NOTICE:

The pump internal relief valve is designed to protect the pump from excessive pressure and must not be used as a system pressure control valve.

HXL pump models are offered with an optional relief valve assembly bolted onto the pump casing. Pumping volatile liquids under suction lift may cause cavitation. Partial closing of the discharge valve WILL result in internal relief valve chatter and is NOT recommended. For these applications, Install an external system pressure control valve, and any necessary bypass piping, back to the storage tank.

A system pressure control valve is also recommended when operating for extended periods (more than 15 seconds) against a closed discharge valve.

RELIEF VALVE SETTING AND ADJUSTMENT



Incorrect settings of the pressure relief valve can cause pump component failure, personal injury, and property damage.

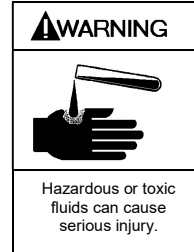

Relief valve cap is exposed to pumpage and will contain some fluid

The factory relief valve pressure setting is marked on a metal tag attached to the valve cover. The relief valve must be set at least 10 - 20 psi (0.7-1.4 bar) higher than the maximum system operating pressure or the system pressure control valve setting.

DO NOT remove the R /V Cap OR adjust the relief valve pressure setting while the pump is in operation.

1. To **INCREASE** the pressure setting, remove the relief valve cap, loosen the locknut, and turn the adjusting screw *inward*, or clockwise. Replace the valve cap.
2. To **DECREASE** the pressure setting, remove the relief valve cap, loosen the locknut, and turn the adjusting screw *outward*, or counterclockwise. Replace the valve cap.

Refer to the individual Blackmer pump parts lists for various spring pressure ranges. Unless specified otherwise, pumps are supplied from the factory with the relief valve adjusted to the mid-point of the spring range.

MAINTENANCE

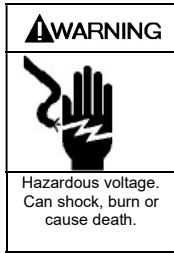

Failure to disconnect and lockout electrical power before attempting maintenance can cause shock, burns or death

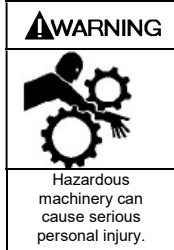

Failure to disconnect and lockout electrical power or engine drive before attempting maintenance can cause shock, burns or death

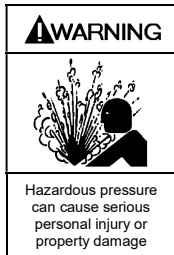

Failure to relieve system pressure prior to performing pump service or maintenance can cause serious personal injury or property damage.

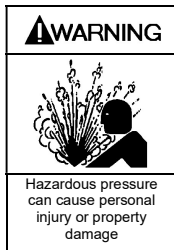

Disconnecting fluid or pressure containment components during pump operation can cause serious personal injury, death or major property damage

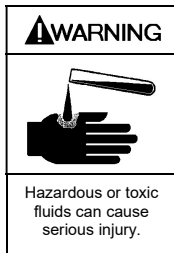

If pumping hazardous or toxic fluids, system must be flushed and decontaminated, inside and out, prior to performing service or maintenance



Always use a lifting device capable of supporting the full weight of the pump assemblies.

NOTICE:

Maintenance shall be performed by qualified technicians only, following the appropriate procedures and warnings as presented in this manual.

TORQUE TABLE

Capscrew Torque Values			
	Head	Hub	Bearing Cover
HXL6	100 lbs-ft. (136 Nm)	---	50 lbs-ft. (68 Nm)
HXL8	178 lbs-ft. (241 Nm)	50 lbs-ft. (68 Nm)	50 lbs-ft. (68 Nm)
HXLJ8	178 lbs-ft. (241 Nm)	---	50 lbs-ft. (68 Nm)
HXL10	178 lbs-ft. (241 Nm)	100 lbs-ft. (136 Nm)	50 lbs-ft. (68 Nm)

SCHEDULED MAINTENANCE

STRAINERS

Strainers must be cleaned regularly to avoid pump starvation. Schedule will depend upon the application and conditions.

LUBRICATION

NOTICE:

To avoid possible entanglement in moving parts do not lubricate pump bearings, gear reducer or any other parts while the pump is running.

NOTICE:

If pumps are repainted in the field, ensure that the grease relief fittings (76A) are functioning properly after painting. Do NOT paint them closed. Remove any excess paint from the fittings.

Ball bearings must be lubricated every three months at minimum. More frequent lubrication may be required depending on the application and operating conditions.

Recommended Grease:

Models: HXL6, HXL8 and HXL10

Mobil® - Mobilgrease XHP222,
Exxon® - RONNEX MP Grease,
or equivalent.

Model: HXLJ8

Exxon® - Polyres, or Mobil® - MOBIL Poly 372, or equivalent Polyurea grease.

Greasing Procedure:

1. Remove the grease relief fittings (76A) from the bearing covers (27 and 27A).
2. SLOWLY apply grease with a hand gun until grease begins to escape from the grease relief fitting port. Discard excess grease in accordance with proper codes and regulations.
3. Replace the grease relief fittings (76A).

DO NOT overgrease pump bearings. While it is normal for some grease to escape from the grease tell-tale hole after lubrication, excessive grease can cause mechanical seal failure. The tell-tale hole is located in the head or hub between the bearing and the seal.

Lubricate the ball bearings, and hydraulic motor couplings (if equipped), every three months at a minimum

MAINTENANCE

VANE REPLACEMENT

NOTICE:

Maintenance shall be performed by qualified technicians only, following the appropriate procedures and warnings as presented in manual.

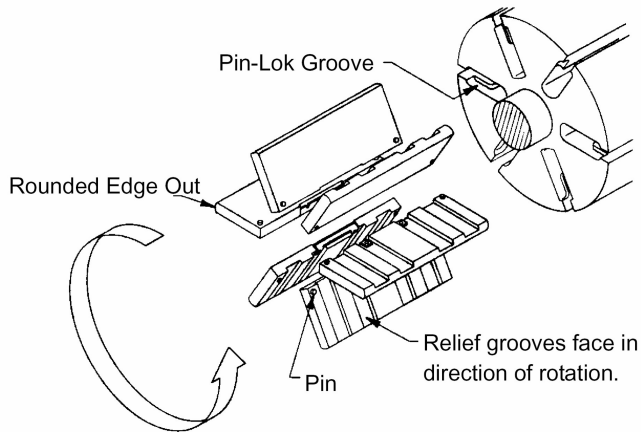

Figure 5 – Vane Installation

1. Vanes may be replaced with the pump in the upright position.
2. Flush the pump per instructions in this manual. Drain and relieve pressure from the pump and system as required.
3. Remove the head assembly from the **outboard** (nondriven) side of the pump according to steps 4 - 8 in the "Pump Disassembly" section of this manual.
4. Turn the shaft by hand until a vane comes to the top (12 o'clock) position of the rotor. Remove the vane.
5. Install a new vane, ensuring that the rounded edge is UP, and the relief grooves are facing towards the direction of rotation. See Figure 5.
6. Repeat steps 3 and 4 until all vanes have been replaced. This method of vane installation ensures the push rods do not fall out of their rotor slots.
7. Reassemble the pump according to the "Pump Assembly." section of this manual.

MAINTENANCE: HXL6 and HXLJ8 MODELS

PUMP DISASSEMBLY – HXL6 and HXLJ8

NOTICE:

Follow all hazard warnings and instructions provided in the “Maintenance” section of this manual.



Always use a lifting device capable of supporting the full weight of the pump assemblies.

NOTICE:

Use a hoist and appropriate sling or lifting lugs attached to the baseplate to lift the entire pump assembly. Eyebolts attached to the pump, gearbox, or motor must be used to lift that particular component only.

NOTICE:

Use a hoist and eyebolts installed in the threaded holes located in the heads, discs, rotor and casing to lift the heavy pump parts.

Note: If a seal or vanes are to be replaced, the pump may be left in the upright position. If the rotor-shaft or liner is to be removed, the pump will have to be placed on its side for some operations.

1. Flush the pump per instructions in this manual. Relieve pressure from the pump and system and drain as required.
HXLJ8: A 3/4" plug (29) is fitted in each head to allow draining the coolant.
2. Set the pump upright. Clean the pump shaft thoroughly, making sure the shaft is free of nicks and burrs. This will prevent damage to the mechanical seal when the inboard head assembly is removed.
3. HXL6: Remove the inboard bearing cover capscrews (28) and slide the inboard bearing cover (27A) and gasket (26) off the shaft. Discard the bearing cover gasket.
HXLJ8: Remove the inboard bearing cover capscrews (28), head capscrews (21), and the head stud nuts (21C). Slide the inboard bearing cover (27A) and gasket (26) off the shaft. Discard the bearing cover gasket.
4. Remove the head capscrews (21). If necessary, place head capcrews in the two tapped holes near the outer rim of the head and tighten until the head separates from the casing. Use a hoist to remove the head from the casing, being careful not to damage the shaft.
The bearing, stationary seat and stationary O-ring will come off with the head assembly.
HXLJ8: Remove the two head studs.
5. Remove the head O-ring (72) and disc (71). If needed, threaded holes are provided in the disc to break it free.

6. Remove the top vane then rotate the shaft by hand to bring the next vane to the top until all the vanes have been removed. If the vanes are swollen or jammed in their slots, the rotor-shaft must be removed as described below.
7. Set the pump on its side with the shaft pointing up.
8. Attach a hoist to the rotor-shaft, lift it out and set aside. The pushrods, and rotating portions of the seal will come out with the rotor-shaft.
9. Set the pump upright.
10. Remove the outboard head components as described for the inboard side in steps 3 – 5.
11. Attach a hoist to the liner. Use a block of wood or piece of brass against the end of the liner, and drive the liner out of the casing with a hammer by tapping the outside diameter of the liner.

PUMP ASSEMBLY – HXL6 and HXLJ8

Before reassembling the pump, inspect all component parts for wear or damage, and replace as required. Wash out the bearing/seal recess of the head and remove any burrs or nicks from the rotor and shaft. Remove any burrs from the liner.

NOTICE:

Use a hoist and eyebolts installed in the threaded holes located in the heads, discs, rotor and casing to lift the heavy pump parts.



Always use a lifting device capable of supporting the full weight of the pump assemblies.

1. Set the pump casing upright.
2. Align the keyway in the top of the liner with the pin in the top of the casing.
HXL6: Liner is symmetrical and can be installed in either direction.
HXLJ8: The liner must be installed in the pump casing with the word “INTAKE” cast on the liner toward the intake port of the pump casing.
 - a. Uniformly tap the outer edge of the liner with a rubber mallet to fully insert into the casing.
3. Start assembly on the OUTBOARD non-driven side of the pump:
For a CLOCKWISE rotation pump, the INTAKE port is to the left.
For a COUNTERCLOCKWISE rotation pump, the INTAKE port is to the right.
Loosely assemble the outboard disc (71), head (20) (and bearing cover (27) on the HXLJ8) to the casing (12). The bearing, seal, O-rings, etc. will be installed later.
4. Set the pump on its side with the outboard head DOWN.

MAINTENANCE: HXL6 and HXLJ8 MODELS

5. Remove the vanes (14) and push rods (77) from the rotor and shaft assembly. Inspect for wear and damage, and replace as follows:
 - a. Insert the three push rods (77) into the rotor.
 - b. Using a hoist, lower the non-driven end of the rotor and shaft into the open side of the pump casing being careful not to hit the disc with the shaft.
 6. Insert the vanes into the rotor slots with the relief grooves facing in the direction of pump rotation, and with the rounded edges outward. See Figure 5. Using a hoist, install the disc in the casing with the smooth side of the disc towards the casing (seal cavity outward) and the pressure relief hole towards the bottom of the casing (6 o'clock position).
 7. Install a new head O-ring (72).
 8. The mechanical seal and bearing must be installed before attaching head to pump casing.
 - a. Apply a small amount of motor oil on the shaft between the shaft threads and the rotor. Wrap tape over the shaft threads to prevent damage to mechanical seal O-rings.
 - b. Slide the seal jacket assembly over the shaft and into the seal cavity with the drive tangs of the jacket towards the rotor. Rotate the jacket assembly to engage the drive tangs in the rotor slots.
 - c. Install a new rotating O-ring (153L) in the rotating seal face (153F). Align and insert the rotating assembly into the seal jacket with the polished face outward. Clean the polished face with a clean tissue and alcohol. Bronze seal faces should be oiled during installation, but other seal faces must be kept clean and dry. Note: Carbon/PTFE rotating seal face (153M) is installed as a one-piece assembly.
 - d. Apply a small amount of motor oil in the seal recess of the head
 - e. Install a new stationary O-ring (153D) in the stationary seat (153B). Clean the polished face with a clean tissue and alcohol, then push the seat fully into the seal recess with the polished face outward.
 - f. Hand pack the ball bearing (24) with grease. Refer to the "Lubrication" section for the recommended grease. Install the bearing into the recess of the head.
 - g. Inspect the grease seal (104) for wear or damage and replace as required. Grease the outside diameter of the grease seal and push it into the inboard bearing cover (27A) with the lip of the seal outward.
 - h. Attach bearing cover (27A) and gasket (26) to head. Make sure the grease fittings (76) on the bearing covers are accessible. Install and torque the bearing cover capscrews (28) as indicated in the "Torque Table".
 - i. Using a hoist, carefully attach the head to the casing. Use care not to damage seal components during installation. Install and HAND-TIGHTEN the head capscrews (21).
 - j. HXLJ8: Install head studs (21B) and hand-tighten the nuts (21C).
 9. Set the pump upright.
 10. Remove the outboard head and disc temporarily attached earlier.
 11. Complete assembly on the OUTBOARD side of the pump as instructed for the inboard side in steps 6 – 8.
 12. Ensure that the pump turns freely. If binding occurs, tap the rim of the head with a mallet until binding is relieved and shaft turns freely. Torque head capscrews as indicated in the "Torque Table" (and studnuts on the HXLJ8) and recheck for free turning.
 13. **RELIEF VALVE ASSEMBLY (if equipped)**
 - a. Insert the valve (9) into the relief valve body(6) with the fluted end inward.
 - b. Install the relief valve spring (8), spring guide (7) and guide rod (45) against the valve.
 - c. Attach a new relief valve gasket (10) and the valve cover (4) on the cylinder.
 - d. Screw the relief valve adjusting screw (2) into the valve cover until it makes contact with the spring guide (7).
 - e. Install the relief valve cap (1) and gasket (88) after the relief valve has been precisely adjusted.
- NOTICE:**
The relief valve setting MUST be tested and adjusted more precisely before putting the pump into service. Refer to "Relief Valve Setting and Adjustment"
14. Reinstall coupling, shaft key, and coupling guards.

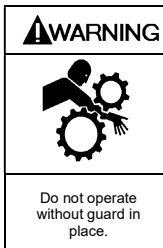

Operation without guards in place can cause serious personal injury, major property damage, or death.

15. Refer to "Pre-Start Up Check List" and "Start Up Procedures" sections of this manual prior to pump operation.

MAINTENANCE: HXL8 and HXL10 MODELS

PUMP DISASSEMBLY – HXL8 and HXL10

NOTICE:

Follow all hazard warnings and instructions provided in the “Maintenance” section of this manual.



Always use a lifting device capable of supporting the full weight of the pump assemblies.

NOTICE:

Use a hoist and appropriate sling or lifting lugs attached to the baseplate to lift the entire pump assembly. Eyebolts attached to the pump, gearbox, or motor must be used to lift that particular component only.

NOTICE:

Use a hoist and eyebolts installed in the threaded holes located in the heads, discs, rotor and casing to lift the heavy pump parts.

Note: If a seal or vanes are to be replaced, the pump may be left in the upright position. If the rotor-shaft or liner is to be removed, the pump will have to be placed on its side for some operations.

1. Flush the pump per instructions in this manual. Drain and relieve pressure from the pump and system as required. A 3/4" drain plug (29) is fitted in each head.
2. **With the pump upright.** Clean the pump shaft thoroughly, making sure the shaft is free of nicks and burrs. This will prevent damage to the mechanical seal when the inboard hub or head assembly is removed.
3. Remove the inboard bearing cover capscrews (28) and slide the inboard bearing cover (27A) and gasket (26) off the shaft. Discard the bearing cover gasket.
4. Remove the outboard bearing cover capscrews (28) and slide the outboard bearing cover (27) and gasket (26) off the shaft. Discard the bearing cover gasket.
5. Removing the locknuts and lockwashers (24A and 24B):
 - a. Bend up the engaged lockwasher tang and rotate the locknut counterclockwise to remove it from the shaft
 - b. Slide the lockwasher off the shaft. Inspect the lockwasher for damage and replace as required.
 - c. Repeat steps a and b on the opposite shaft end.
6. Remove the capscrews from the hub (21A) and slide the hub assembly off the shaft. The bearing, stationary seat and stationary O-ring of the mechanical seal (153B, 153D) will come off with the hub.
 - a. Pull the bearing (24) from the housing in the hub.
 - b. To remove the mechanical seal stationary seat (153B), remove the seal retaining screws and washers (153Q, 153R, 153S) Gently push the backside of the stationary seat from the seal recess. Place a cloth under the seal to avoid damage. Be careful not to contact the polished face of the seal during removal. Remove and discard mechanical seal stationary O-ring.
 - c. Remove the remaining mechanical seal parts, including the seal jacket and rotating face (153F, 153L, 153G) from the shaft. A piece of stiff wire with a hook on the end may be used to withdraw the seal components from the shaft. Remove and discard rotating O-ring
7. Remove the head capscrews (21). If necessary, place head capscrews in the two tapped holes near the outer rim of the head and tighten until the head separates from the casing. Use a hoist to remove the head from the casing, being careful not to damage the shaft.
8. HXL8: Remove the head O-ring (72) and disc (71). If needed, threaded holes are provided in the disc to break it free.
HXL10: The head O-ring (72) and disc (71) will come off with the head assembly. Remove the counter sunk set screws and lockwashers (71A & 71B) to release the disc from the head. Install an eyebolt in the disc and use a hoist to remove the disc from the head.
9. Remove the top vane then rotate the shaft by hand to bring the next vane to the top until all the vanes have been removed. If the vanes are swollen or jammed in their slots, the rotor-shaft must be removed.
10. Set the pump on its side with the shaft pointing up.
11. Attach a hoist to rotor-shaft, lift it out and set it aside. The pushrods, and rotating portions of the seal will come out with the rotor-shaft.
12. Set the pump upright.
13. Remove the outboard head components as described from the inboard side in steps 6 - 8.
14. HXL10: Remove the four (4) liner retaining screws and washers (127, 127A) located between the relief valve ports.
15. Attach a hoist to the liner. Use a block of wood or piece of brass against the end of the liner, and drive the liner out of the casing with a hammer by tapping the outside diameter of the liner.

MAINTENANCE: HXL8 and HXL10 MODELS

PUMP ASSEMBLY – HXL8 and HXL10

Before reassembling the pump, inspect all component parts for wear or damage, and replace as required. Wash out the bearing/seal recess of the head and remove any burrs or nicks from the rotor and shaft. Remove any burrs from the liner.

NOTICE:

Use a hoist and eyebolts installed in the threaded holes located in the heads, discs, rotor and casing to lift the heavy pump parts.



Always use a lifting device capable of supporting the full weight of the pump assemblies.

1. Set the pump casing upright.
2. The liner must be installed in the pump casing with the word "INTAKE" cast on the liner toward the intake port of the pump casing.
HXL8: Align the keyway in the top of the liner with the pin in the top of the casing.
HXL10: Align rib at top of the liner between the liner retainer screw holes.
Uniformly tap the outer edge of the liner with a rubber mallet to fully insert into the casing.
HXL10: Install four liner retainer screws and seals (127, 127A)
3. Start assembly on the **OUTBOARD** non-driven side of the pump:
For a **CLOCKWISE** rotation pump, the INTAKE port is to the **left**.
For a **COUNTERCLOCKWISE** rotation pump, the INTAKE port is to the **right**.
Loosely assemble the outboard disc (71) and head (20) to the casing (12). The bearing, seal, O-rings, etc. will be installed later.
4. Set the pump on its side with the outboard head **DOWN**.
5. Remove the vanes (14) and push rods (77) from the rotor and shaft assembly. Inspect for wear and damage, and replace as follows:
 - a. Insert the three push rods (77) into the rotor.
 - b. Using a hoist, lower the non-driven end of the rotor and shaft into the open side of the pump casing, being careful not to hit the disc with the shaft.
 - c. Insert the vanes into the rotor slots with the relief grooves facing in the direction of pump rotation, and with the rounded edges outward. See Figure 5.
6. HXL8: Using a hoist, install the disc in the casing with the smooth side of the disc towards the casing (seal cavity outward) and the pressure relief hole towards the bottom of the casing (6 o'clock position).
HXL10: Using a hoist, place the disc (71) on the head with the counterbored screw holes facing out. The word "INTAKE" on the disc should be positioned so that it faces the intake side of the pump when the head is attached to the casing with the head drain hole towards the bottom of the pump. Install the six (6) disc retaining screws (71A) and lockwashers (71B).
7. Install a new head O-ring (72).
8. Using a hoist, carefully attach the head (20) to the casing with the head drain hole towards the bottom of the pump. Install and tighten the head capscrews (21).
9. The mechanical seal components and the bearing must be installed before attaching hub to head.
 - a. Apply a small amount of motor oil on the shaft between the shaft threads and the rotor. Wrap tape over the shaft threads to prevent damage to mechanical seal O-rings.
 - b. Slide the seal jacket assembly over the shaft and into the seal cavity with the drive tangs of the jacket towards the rotor. Rotate the jacket assembly to engage the drive tangs in the rotor slots.
 - c. Install a new rotating O-ring (153L) in the rotating seal face (153F). Align and insert the rotating assembly into the the seal jacket with the polished face outward. Clean the polished face with a clean tissue and alcohol. Bronze seal faces should be oiled during installation, but other seal faces must be kept clean and dry. Note: Carbon/PTFE rotating seal face (153M) is installed as a one-piece assembly.
 - d. Apply a small amount of motor oil in the hub seal recess.
 - e. Install a new stationary O-ring (153D) in the stationary seat (153B). Clean the polished face with a clean tissue and alcohol. Push the seat fully into the seal recess with the polished face outward.
 - f. Install seal retaining screws and washers (153Q, 153R, 153S).
 - g. Hand pack the ball bearing (24) with grease. Refer to the "Lubrication" section for the recommended grease.
 - h. Install the bearing into the recess of the hub (20C).
 - i. Temporarily attach the bearing cover (27) and gasket (26) to hub and hand tighten capscrews (28).
 - j. Install new hub O-ring (72B) and carefully install the hub assembly (20C) on head. Install and tighten hub capscrews (21A) torquing as indicated in the "Torque Table" on
10. Remove the bearing cover and loosely install the bearing locknut and lockwasher (24A, 24B). Snug the locknut on the outboard head to help square the rotor with the head. **DO NOT** overtighten the nut.
11. Set the pump upright.
12. Remove the outboard head and disc temporarily attached earlier.
13. Complete assembly on the **OUTBOARD** side of the pump as instructed for the inboard side in steps 6 -10, leaving the head capscrews loosely tightened.
14. Loosen the bearing locknut on the outboard head and rotate the shaft to test for binding or tight spots. If the rotor does not turn freely, lightly tap the rims of the heads with a soft faced mallet until the correct position is found. Retighten all head capscrews, torquing to the specifications indicated in the "Torque Table".

MAINTENANCE: HXL8 and HXL10 MODELS

15. LOCKNUT ADJUSTMENT

It is important that the bearing locknuts (24A) and lockwashers (24B) be installed and adjusted properly. Overtightened locknuts can cause bearing failure or a broken lockwasher tang. Loose locknuts will allow the rotor to shift against the discs, causing wear. See Figure 6.

- a. On both ends of the pump shaft, install a lockwasher (24B) with the tangs facing outward, followed by a locknut (24A) with the tapered end inward. Ensure the inner tang "A" of the lockwasher is located in the slot in the shaft threads, bending it slightly, if necessary.

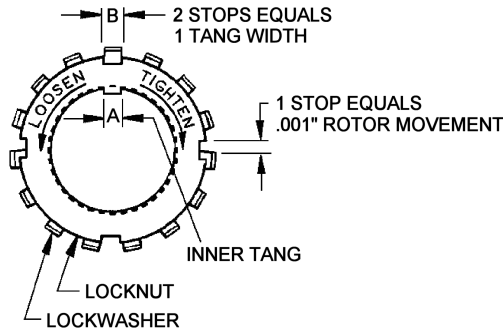
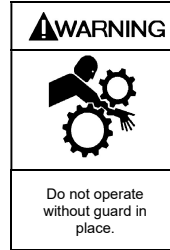

Figure 6 Locknut Adjustment

- b. Tighten both locknuts to ensure that the bearings are bottomed in the head recess. **DO NOT** overtighten and bend or shear the lockwasher inner tang.
 - c. Loosen both locknuts one complete turn.
 - d. Tighten one locknut until a slight rotor drag is felt when turning the shaft by hand.
 - e. Back off the nut the width of one lockwasher tang "B". Secure the nut by bending the closest aligned lockwasher tang into the slot in the locknut. The pump should turn freely when rotated by hand.
 - f. Tighten the opposite locknut by hand until it is snug against the bearing. Then, using a spanner wrench, tighten the nut the width of one lockwasher tang. Tighten just past the desired tang, then back off the nut to align the tang with the locknut slot. Secure the nut by bending the aligned lockwasher tang into the slot in the locknut. The pump should continue to turn freely when rotated by hand.
16. Inspect the grease seal (104) for wear or damage and replace as required. Grease the outside diameter of the grease seal and push it into the inboard bearing cover (27A) with the lip of the seal outward.
 17. Attach a new bearing cover gasket (26) and the inboard bearing cover (27A) to the inboard side of the pump. Install the outboard bearing cover (27) and a new gasket to the outboard side of the pump. Make sure the grease fittings (76) on the bearing covers are accessible. Install and torque the bearing cover capscrews (28) as indicated in the "Torque Table".



Operation without guards in place can cause serious personal injury, major property damage, or death.

18. RELIEF VALVE ASSEMBLY (if equipped)

- a. Insert the valve (9) into the relief valve body(6) with the fluted end inward.
- b. Install the relief valve spring (8), spring guide (7) and guide rod (45) against the valve.
- c. Attach a new relief valve gasket (10) and the valve cover (4) on the cylinder.
- d. Screw the relief valve adjusting screw (2) into the valve cover until it makes contact with the spring guide (7).
- e. Install the relief valve cap (1) and gasket (88) after the relief valve has been precisely adjusted.

NOTICE:

The relief valve setting **MUST** be tested and adjusted more precisely before putting the pump into service. Refer to "Relief Valve Setting and Adjustment"

19. Reinstall coupling, shaft key, and coupling guards.
20. Refer to "Pre-Start Up Check List" and "Start Up Procedures" sections of this manual prior to pump operation.

TROUBLESHOOTING

NOTICE:

Maintenance shall be performed by qualified technicians only, following the appropriate procedures and warnings as presented in this manual.

SYMPTOM	PROBABLE CAUSE
Pump Not Priming	<ol style="list-style-type: none"> 1. Pump not wetted. 2. Worn vanes. 3. Suction valve closed. 4. Internal control valve closed. 5. Air leaks in the suction line. 6. Strainer clogged. 7. Suction line or valves clogged or too restrictive. 8. Broken drive train. 9. Pump vapor-locked. 10. Pump speed too low for priming. 11. Relief valve partially open, worn or not seating properly. 12. Vanes installed incorrectly (see "Vane Replacement"). 13. Incorrect Rotation
Reduced Capacity	<ol style="list-style-type: none"> 1. Pump speed too low. 2. Suction valves not fully open. 3. Air leaks in the suction line. 4. Excessive restriction in the suction line (i.e.: undersized piping, too many elbows & fittings, clogged strainer, etc.). 5. Damaged or worn parts (vanes, discs, liner or rotor). 6. Excessive restriction in discharge line causing partial flow through the relief valve. 7. Relief Valve worn, set too low, or not seating properly. 8. Vanes installed incorrectly (see "Vane Replacement"). 9. Liner installed backwards.
Noise	<ol style="list-style-type: none"> 1. Excessive vacuum on the pump due to: (or: Excessive pressure drop in suction line due to:) <ol style="list-style-type: none"> a. Undersized or restricted fittings in the suction line. b. Pump speed too fast for the viscosity or volatility of the liquid. c. Pump too far from fluid source. d. Suction Lift too great. 2. Entrained Air or Vapor in the pumpage. 3. Running the pump for extended periods with a closed discharge line. 4. Pump not securely mounted. 5. Misalignment of pump, reducer or motor. 6. Improper drive line (see "Pump Drive"). 7. Bearings worn or damaged. 8. Vibration from improperly anchored piping. 9. Bent shaft, or drive coupling misaligned. 10. Insufficient oil in the gear reducer. 11. Excessively worn rotor. 12. Malfunctioning valve in the system. 13. Relief valve setting too low. 14. Liner installed backwards. 15. Damaged vanes (see following category).

TROUBLESHOOTING

NOTICE:

Maintenance shall be performed by qualified technicians only, following the appropriate procedures and warnings as presented in this manual.

SYMPTOM	PROBABLE CAUSE
Damaged Vanes	<ol style="list-style-type: none"> 1. Foreign objects entering the pump. 2. Running the pump dry for extended periods of time. 3. Cavitation. 4. Viscosity too high for the vanes and /or the pump speed. 5. Incompatibility with the liquids pumped. 6. Excessive heat. 7. Worn or bent push rods, or worn push rod holes. 8. Settled or solidified material in the pump at start-up. 9. Hydraulic hammer - pressure spikes. 10. Vanes installed incorrectly (see"Vane Replacement").
Broken Shaft	<ol style="list-style-type: none"> 1. Foreign objects entering the pump. 2. Viscosity too high for the pump speed. 3. Relief valve not opening. 4. Hydraulic hammer - pressure spikes. 5. Pump/driver, driveline/drive shaft misalignment. 6. Excessively worn vanes or vane slots. 7. Settled or solidified material in the pump at start-up. 8. Overtightened V-belts, if used.
SEAL LEAKAGE	<ol style="list-style-type: none"> 1. O-rings not compatible with the liquids pumped. 2. O-rings nicked, cut or twisted. 3. Shaft at seal area damaged, worn or dirty. 4. Ball bearings overgreased. 5. Pump sleeve bearings worn excessively. 6. Excessive cavitation. 9. Mechanical seal faces cracked, scratched, pitted or dirty.
MOTOR OVERLOAD	<ol style="list-style-type: none"> 1. Horsepower of motor not sufficient for application 2. Improper wire size / wiring and/or voltage to motor. 3. Misalignment in pump drive system. 4. Excessive viscosity, pressure or speed. 5. Bearing locknuts adjusted improperly. 6. Faulty or worn bearings. 7. Rotor rubbing against head or cylinder. 8. Dirty mechanical seal faces.



1809 Century Avenue, Grand Rapids, Michigan 49503-1530 U.S.A.
Telephone: (616) 241-1611 • Fax: (616) 241-3752
E-mail: blackmer@blackmer.com • Internet Address: www.blackmer.com