

BLACKMER POWER PUMPS

960052

INSTRUCTIONS 103-A00

INSTALLATION OPERATION AND MAINTENANCE INSTRUCTIONS

Section	103
Effective	June 2022
Replaces	Oct 2015

**MODELS: NP1.5B, NP2F, NP2.5F, NP3F, NP4F,
NPH2F, NPH2.5F, NPH3F, NPH4F**



TABLE OF CONTENTS	Page
PUMP DATA	
Safety Data	1 - 2
Technical Data	2
Initial Pump Start Up Information	2
INSTALLATION	
Pre-Installation Cleaning	3
Location and Piping	3
Mounting	3
Coupling Alignment	4
Pump Rotation	4
Heating Heads / Jackets	4
Heating Heads / Electric	4
Check Valves	4
OPERATION	
Pre-Start Up Check List	5
Start Up Procedures	5
Running the Pump in Reverse Rotation	5
Flushing the Pump	6
Pump Relief Valve	6
Relief Valve Setting and Adjustment	6
MAINTENANCE	
Strainers	7
Lubrication	7
Vane Replacement	7
Pump Disassembly	8
Pump Assembly	8
TROUBLE SHOOTING	10
AFFP PUMPS	11

NOTE: Numbers in parentheses following individual parts indicate reference numbers on Blackmer Parts Lists.

Blackmer pump manuals and parts lists may be obtained from Blackmer's website (www.blackmer.com) or by contacting Blackmer Customer Service.

NP1.5	NP2	NP2.5	NP3	NP4
103-A01	103-A02	103-A03	103-A04	103-A05
	NPH2	NPH2.5	NPH3	NPH4
	103-A12	103-A13	103-A14	103-A06

SAFETY DATA



This is a SAFETY ALERT SYMBOL.

When you see this symbol on the product, or in the manual, look for one of the following signal words and be alert to the potential for personal injury, death or major property damage



Warns of hazards that **WILL** cause serious personal injury, death or major property damage.



Warns of hazards that **CAN** cause serious personal injury, death or major property damage.



Warns of hazards that **CAN** cause personal injury or property damage.

NOTICE:

Indicates special instructions which are very important and must be followed.

NOTICE:

Blackmer Pumps **MUST** only be installed in systems, which have been designed by qualified engineering personnel. The system **MUST** conform to all applicable local and national regulations and safety standards.

This manual is intended to assist in the installation and operation of the Blackmer NP Series pumps, and **MUST** be kept with the pump.

Pump service shall be performed by qualified technicians **ONLY**. Service shall conform to all applicable local and national regulations and safety standards.

Thoroughly review this manual, all instructions and hazard warnings, **BEFORE** performing any work on the pump.

Maintain **ALL** system and pump operation and hazard warning decals.

SAFETY DATA

⚠ WARNING



Hazardous machinery can cause serious personal injury.

Failure to disconnect and lockout electrical power or engine drive before attempting maintenance can cause severe personal injury or death

⚠ WARNING



Hazardous voltage. Can shock, burn or cause death.

Failure to disconnect and lockout electrical power before attempting maintenance can cause shock, burns or death

⚠ WARNING



Hazardous or toxic fluids can cause serious injury.

If pumping hazardous or toxic fluids, system must be flushed and decontaminated, inside and out, prior to performing service or maintenance

⚠ WARNING



Hazardous pressure can cause personal injury or property damage

Disconnecting fluid or pressure containment components during pump operation can cause serious personal injury, death or major property damage

⚠ WARNING



Do not operate without guard in place

Operation without guards in place can cause serious personal injury, major property damage, or death.

⚠ WARNING



Hazardous pressure can cause personal injury or property damage

Failure to relieve system pressure prior to performing pump service or maintenance can cause personal injury or property damage.

⚠ WARNING



Hazardous machinery can cause severe personal injury.

Failure to stop the pump before adjusting the shaft packing can cause severe personal injury

PUMP DATA

PUMP IDENTIFICATION

A pump Identification tag, containing the pump serial number, I.D. number, and model designation, is attached to each pump. It is recommended that the data from this tag be recorded and filed for future reference. If replacement parts are needed, or if information pertaining to the pump is required, this data must be furnished to a Blackmer representative.

TABLE 1 – TECHNICAL DATA

	1.5", 2", 2.5", 3"	4"
Maximum Pump Speed	640 RPM	500 RPM
Maximum Operating Temperature*	240°F (115°C)	
Maximum Viscosity*	20,000 SSU (4,250 cP)	
Maximum Differential Pressure*	150 psi (10.3 Bar) Standard Build 200 psi (13.9 Bar) Optional Build	
Maximum Working Pressure*	175 psi (12.1 Bar) Standard Build 225 psi (15.5 Bar) Optional Build	

* Technical Data is for standard materials of construction. Consult Blackmer Material Specs for optional materials of construction.

cP = centistokes at fluid specific gravity of 1.0.

INITIAL PUMP START UP INFORMATION

Model No.:	_____
Serial No.:	_____
ID No.:	_____
Date of Installation:	_____
Inlet Gauge Reading:	_____
Discharge Gauge Reading:	_____
Flow Rate:	_____

INSTALLATION

NOTICE:

Blackmer pumps must only be installed in systems designed by qualified engineering personnel. System design must conform with all applicable regulations and codes and provide warning of all system hazards.



- ⚠ Install, ground and wire to local and National Electrical Code requirements.
- ⚠ Install an all-leg disconnect switch near the unit motor.
- ⚠ Disconnect and lockout electrical power before installation or service
- ⚠ Electrical supply **MUST** match motor nameplate specifications.

- ⚠ Motors equipped with thermal protection automatically disconnect motor electrical circuit when overload exists. Motor can start unexpectedly and without warning.

PRE-INSTALLATION CLEANING

NOTICE:

New pumps contain residual test fluid and rust inhibitor. If necessary, flush pump prior to use.

Foreign matter entering the pump WILL cause extensive damage. The supply tank and intake piping MUST be cleaned and flushed prior to pump installation and operation.

LOCATION AND PIPING

Pump life and performance will be significantly reduced when installed in an improperly designed system. Before starting the layout and installation of the piping system, review the following:

1. Locate the pump as near as possible to the source of supply to avoid excessive inlet pipe friction.
2. The inlet line must be at least as large as the intake port on the pump. It should slope downward to the pump, and should not contain any upward loops. Eliminate restrictions such as sharp bends, globe valves, unnecessary elbows, and undersized strainers.
3. A strainer should be installed in the inlet line to protect the pump from foreign matter. The strainer should be located at least 24" (0.6m) from the pump. For viscosities less than 1,000 SSU (200 cP), the strainer should have a net open area of at least four times the area of the intake piping. For viscosities greater than 1,000 SSU (200 cP), consult the strainer manufacturer instructions. Strainers must be cleaned regularly to avoid pump starvation.
4. The intake system must be free of air leaks.
5. Expansion joints, placed at least 36" (0.9m) from the pump, will compensate for expansion and contraction of the pipes. Contact the flexible connector/hose manufacturer for required maintenance/care and design assistance in their use.
6. Install pressure gauges in the NPT ports provided in the pump casing to check pump at start up.

7. ALL piping and fittings **MUST** be properly supported to prevent any piping loads from being placed on the pump.
8. Check alignment of pipes to pump to avoid strains which might later cause misalignment. See Figure 1. Unbolt flanges or break union joints. Pipes should not spring away or drop down. After pump has been in operation for a week or two, completely recheck alignment.

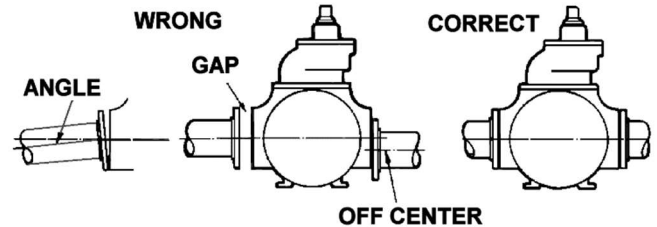

Figure 1

9. The use of an intake side check or foot valve is **NOT** recommended. A properly sized check valve may be installed near the pump discharge.

PUMP MOUNTING

A solid foundation reduces noise and vibration, and will improve pump performance. On permanent installations it is recommended the pumping unit be secured by anchor bolts as shown in Figure 2. This arrangement allows for slight shifting of position to accommodate alignment with the mounting holes in the base plate. Refer to ANSI/HI standards or a suitable pump handbook for information on typical pump mounting and foundations.

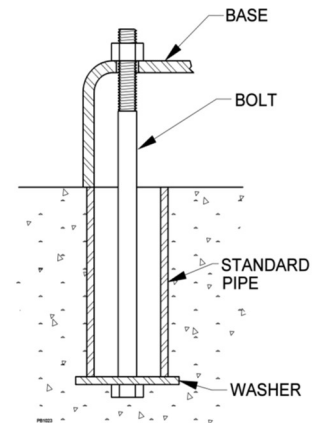

Figure 2 -
Pipe Type
Anchor Bolt Box

For new foundations, it is suggested that the anchor bolts be set in concrete. When pumps are to be located on existing concrete floors, holes should be drilled into the concrete to hold the anchor bolts.

When installing units built on channel or structural steel type bases, use care to avoid twisting the base out of shape when anchor bolts are tightened. Shims should be used under the edges of the base prior to tightening of the anchor bolts to prevent distortion.

INSTALLATION

COUPLING ALIGNMENT

The pump must be directly coupled to a gear and/or driver with a flexible coupling. Verify coupling alignment after installation of new or rebuilt pumps. Both angular and parallel coupling alignment **MUST** be maintained between the pump, gear, motor, etc. in accordance with manufacturer's instructions. See Figure 3.

1. Parallel alignment: The use of a laser alignment tool or dial indicator is preferred. If a laser alignment tool or dial indicator is not available, use a straightedge. Turn both shafts by hand, checking the reading through one complete revolution. Maximum offset should be less than .005" (.127 mm).
2. Angular alignment: Insert a feeler gauge between the coupling halves. Check the spacing at 90° increments around the coupling (four checkpoints). Maximum variation should not exceed .005" (.127 mm). Some laser alignment tools will check angular alignment as well.
3. Replace the coupling guards after setting alignment.

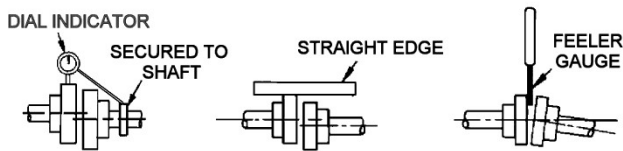
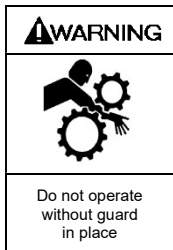

Figure 3 – Alignment Check



Operation without guards in place can cause serious personal injury, major property damage, or death.

PUMP ROTATION

A right-hand pump rotates clockwise with the intake on the right side, when viewed from the driven end.

A left-hand pump rotates counterclockwise with the intake on the left side, when viewed from the driven end.

NOTICE:

Confirm correct pump rotation by checking the pump rotation arrows respective to pump driver rotation.

TO CHANGE PUMP ROTATION

To reverse rotation, the pump must be disassembled then reassembled with the shaft on the opposite side of the pump. See the 'Maintenance' section for instructions.

HEATING HEADS / JACKETS

NOTICE:

Maximum recommended heating jacket steam pressure is 150 PSI (10.3 bar).

Jacketed heads are recommended for heating highly viscous liquids, or to "thaw out" liquids that have congealed in the pumping chamber and packing area.

Hot oil or steam can be circulated through the jacketed heads by 3/4" NPT connections (3/8" NPT on 1.5" models) above and below the shaft.



Pumps fitted with heating devices have hot surfaces that can cause serious personal injury.

HEATING HEADS / ELECTRIC

The 2.5, 3 and 4" pumps may be fitted with heads for electric heating. The inboard head has two 12.5mm bore (85 mm deep) Heating Cartridge ports and two M6 x 1.0 (12 mm deep) Temperature Sensor ports. The outboard bearing cover has one 12.5mm bore (85 mm deep) Heating Cartridge port.

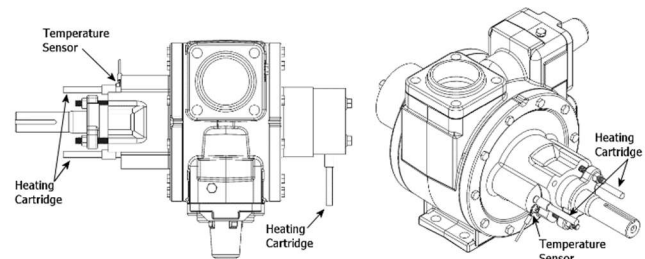

Figure 3a – Heads for Electric Heating

CHECK VALVES

The use of check valves or foot valves in the supply tank is not recommended with self-priming, positive displacement pumps.

If the possibility of liquid backflow exists when the pump is off, a check valve in the pump discharge piping is recommended because the pump can motor in the reverse rotation and create undue stress on all attached components. Never start a pump when it is rotating in the reverse rotation as the added starting torque can damage the pump and related equipment.

OPERATION

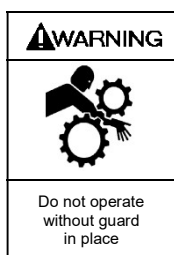

Operation without guards in place can cause serious personal injury, major property damage, or death.

Do not operate without guard in place

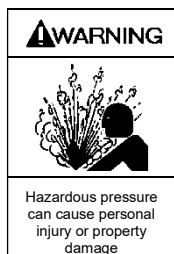

Disconnecting fluid or pressure containment components during pump operation can cause serious personal injury, death or major property damage

Hazardous pressure can cause personal injury or property damage

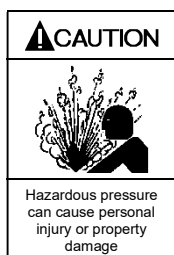

Failure to relieve system pressure prior to performing pump service or maintenance can cause personal injury or property damage.

Hazardous pressure can cause personal injury or property damage

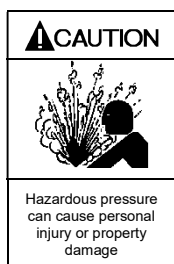

Pumps operating against a closed valve can cause system failure, personal injury and property damage

Hazardous pressure can cause personal injury or property damage

START UP PROCEDURES

NOTICE:

Consult the "General Pump Troubleshooting" section of this manual if difficulties during start up are experienced.

1. Start the pump. Priming should occur within one minute.
2. Check the vacuum and pressure gauges to see if the pump is operating within the expected conditions. Record the readings in the 'Initial Start Up Information' section of this manual for future reference.
3. Inspect piping, fittings, and associated system equipment for leaks, noise, vibration and overheating.
4. If possible, check the flow rate. Record the readings in the 'Initial Start Up Information' section of this manual for future reference.
5. Check the pressure setting of the relief valve by briefly closing a valve in the discharge line and reading the pressure gauge. This pressure should be 10-20 psi (0.7-1.4 bar) higher than the maximum operating pressure, or the external bypass valve setting (if equipped). **DO NOT operate the pump against a closed discharge valve for more than 15 seconds.** If adjustments need to be made, refer to "Relief Valve Setting & Adjustment."

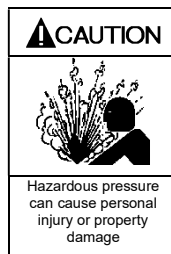

Incorrect settings of the pressure relief valve can cause pump component failure, personal injury, and property damage.

Hazardous pressure can cause personal injury or property damage

PRE-START UP CHECK LIST

1. Check the alignment of the pipes to the pump. Pipes should be supported so that they do not spring away or drop down when pump flanges or union joints are disconnected.
2. Verify proper coupling alignment.
3. If equipped with a gear reducer, check the oil level in the gear reducer. Fill with the grade of oil indicated on the reducer tag. For more specific instructions on Blackmer gear reducers, refer to the appropriate Gear reducer Installation, Operation and Instruction Manual.

NOTICE:

Blackmer gear reducers are not lubricated at the factory. Oil must be added before initial pump start up.

4. Check the entire pumping system to verify that the proper inlet and discharge valves are fully open, and that the drain valves and other auxiliary valves are closed.
5. Install vacuum and pressure gauges on the pump in the 1/4" NPT connections provided to check suction and discharge conditions after pump start-up.
6. Check the wiring of the motor, and briefly turn on the power to make sure that the pump rotates in the direction of the rotation arrow.

RUNNING THE PUMP IN REVERSE ROTATION

NOTICE:

The pump should be operated in reverse rotation for no more than 10 minutes and only when a separate pressure relief valve is installed to protect the pump from excessive pressure.

It may be desirable to run the pump in reverse rotation for system maintenance. The pump will operate satisfactorily in reverse rotation for a LIMITED time, at a reduced performance level.

OPERATION

FLUSHING THE PUMP

NOTICE:

If flushing fluid is to be left in the pump for an extended time, it must be a lubricating, non-corrosive fluid. If a corrosive or non-lubricating fluid is used, it must be flushed from the pump immediately. Water is not suitable to remain in pump after flushing.

1. To flush the pump, run the pump with the discharge valve open and the intake valve closed. Bleed air into the pump through the intake gauge plug hole or through a larger auxiliary fitting in the intake piping. Pump air for 30 second intervals to clean out most of the pumpage.
2. Run a system compatible flushing fluid through the pump for one minute to clear out the remainder of the original pumpage.
3. To remove the flushing fluid, follow step 1 above.

NOTICE:

After flushing the pump some residual fluid will remain in the pump and piping.

NOTICE:

Properly dispose of all waste fluids in accordance with the appropriate codes and regulations.

PUMP RELIEF VALVE

NOTICE:

The pump's internal relief valve is designed to protect only the pump from excessive pressure and must not be used as a system pressure control valve.

The Blackmer pump internal relief valve is designed to protect the pump for a LIMITED time operation, against a partially closed discharge valve by allowing internal fluid recirculation.

An external bypass system is required when operating the pump for periods greater than one minute against a closed or partially closed discharge valve.

The pump relief valve must be set higher than the system pressure control valve, but must not exceed the maximum differential pressure of the pump (see table 1).

RELIEF VALVE SETTING AND ADJUSTMENT

The relief valve pressure setting is marked on a metal tag attached to the valve cover. The relief valve should be set at least 10-20 psi (0.7-1.4 Bar) higher than the operating pressure or system pressure control valve, but no higher than the maximum working pressure of the pump (see Table 1)

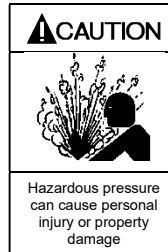

Incorrect settings of the pressure relief valve can cause pump component failure, personal injury, and property damage.

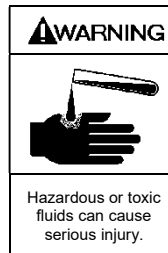

Relief valve cap is exposed to pumpage and will contain some fluid

DO NOT remove the R/V Cap OR adjust the relief valve pressure setting while the pump is in operation.

1. To **INCREASE** the pressure setting, remove the relief valve cap (1) and gasket (88). Loosen the locknut (3), if equipped. Turn the adjusting screw (2) inward, or **CLOCKWISE**. Inspect R/V cap O-ring/gasket (88) and replace as required. Reattach R/V cap O-ring/gasket and R/V cap.
2. To **DECREASE** the pressure setting, remove the relief valve cap (1) and gasket (88). Loosen the locknut (3), if equipped. Turn the adjusting screw (2) outward, or **COUNTERCLOCKWISE**. Inspect R/V cap O-ring/gasket (88) and replace as required. Reattach R/V cap O-ring/gasket and R/V cap.

Refer to the individual Blackmer pump parts lists for various spring pressure ranges. Unless specified otherwise, pumps are supplied from the factory with the relief valve adjusted to the mid-point of the spring range.

MAINTENANCE

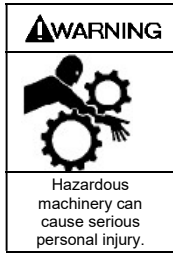

Failure to disconnect and lockout electrical power or engine drive before attempting maintenance can cause severe personal injury or death

Hazardous machinery can cause serious personal injury.

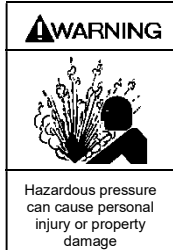

Failure to relieve system pressure prior to performing pump service or maintenance can cause personal injury or property damage.

Hazardous pressure can cause personal injury or property damage

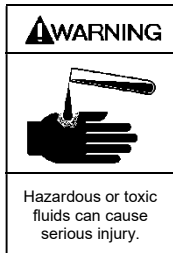

If pumping hazardous or toxic fluids, system must be flushed and decontaminated, inside and out, prior to performing service or maintenance

Hazardous or toxic fluids can cause serious injury.

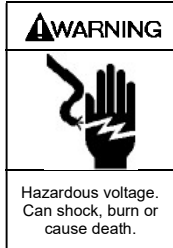

Failure to disconnect and lockout electrical power before attempting maintenance can cause shock, burns or death

Hazardous voltage. Can shock, burn or cause death.

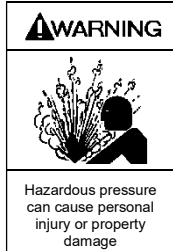

Disconnecting fluid or pressure containment components during pump operation can cause serious personal injury, death or major property damage

Hazardous pressure can cause personal injury or property damage

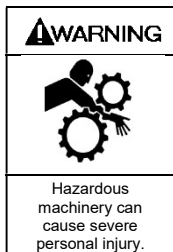

Failure to stop the pump before adjusting the shaft packing can cause severe personal injury

Hazardous machinery can cause severe personal injury.

NOTICE:

Maintenance must follow the indicated schedules, be performed by qualified technicians only, and follow the appropriate procedures and warnings as presented in this manual.

SCHEDULED MAINTENANCE

STRAINERS

Strainers must be cleaned regularly to avoid pump starvation. Schedule will depend upon the application and conditions.

LUBRICATION

NOTICE:

To avoid possible entanglement in moving parts do not lubricate the gear reducer or any other parts while the pump is running.

Sleeve bearings (bushings) are lubricated by the liquid being pumped. Additional lubrication is not required.

IF EQUIPPED: Blackmer gear reducers are shipped from the factory without oil in the gearcase. Fill with the grade of oil indicated on the reducer tag. The oil should be changed after the first 48 hours of use and approximately every 500 hours of use thereafter.

VANE REPLACEMENT

NOTICE:

Maintenance shall be performed by qualified technicians only. Following the appropriate procedures and warnings as presented in manual.

1. Drain and flush the pump and system as required.
2. Remove the head assembly and all other parts on the outboard (non-driven) side of the pump. See the "Pump Disassembly" Section.
3. Turn the shaft by hand until a vane (14) comes to the top (12 o'clock) position of the rotor. Remove the vane.

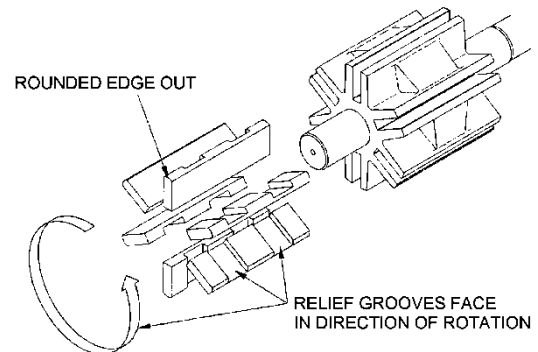

(1.5" and 2" models have only four vanes)

Figure 4 – Vane Replacement

4. Replace the vane, making sure to install the vane with the rounded edge outward to contact the liner and the relief grooves facing the direction of rotation.
5. Rotate the shaft until the next rotor slot is in the top position, and replace the vane. Continue this procedure until all new vanes are in place.
6. Reassemble the pump as instructed in "Pump Assembly."

MAINTENANCE

PUMP DISASSEMBLY

NOTICE:

Follow all hazard warnings and instructions provided in the "Maintenance" section of this manual.

1. Drain and flush the pump and system as required.
2. Starting on the **inboard** (driven) end of the pump, clean the pump shaft thoroughly, making sure the shaft is free of nicks and burrs. This will prevent damage to the lip seal when the inboard head assembly is removed.
3. Remove the shaft key(35), and the packing follower stud nuts (18). Slide the packing follower (75) from the shaft. A slight pry with a screwdriver may be necessary.
4. Pull the packing rings (19) from the stuffing box with the use of a packing removal tool. Use care not to scratch or damage the shaft. Discard packing. Remove the pack washer (58) from the stuffing box.

Note: If the pump is equipped with a commercial mechanical seal, refer to the seal manufacturer's instructions for removal.

5. Remove the inboard head capscrews (21) and pry the head assembly away from the cylinder and off the shaft. Remove head O-ring (72) and discard
6. The sleeve bearing (bushing) (24) is press fit into the head and should not be removed unless replacement is necessary. See step 1 of 'Pump Assembly'.
7. Gently pull the rotor & shaft (13) out of the cylinder. While one hand is pulling the shaft, the other should be cupped underneath to prevent the vanes and push rods from falling out.
8. From the opposite (outboard) side of the pump, remove the bearing cover capscrews (28), bearing cover (27), and bearing cover O-ring (26). Discard the O-ring.
9. Remove the outboard head (23) as instructed in steps 4 through 6 above.

PUMP ASSEMBLY

Before reassembling the pump, inspect all component parts for wear or damage, and replace as required. Wash out the bearing/seal recess of the head and remove any burrs or nicks from the rotor and shaft.

1. Inspect the sleeve bearings (bushings) in both heads for wear or damage and replace as required.

To replace the sleeve bearings (bushings):

- a. Using an appropriately sized arbor press, remove the old bearing from the head.
- b. To aid installation and prevent bearing damage, heat the head in an oven at 200°F (93°C) before installing the bearing.
- c. Coat the bearing with grease and place it on the inside face of the head, with the notched end UP. Align the notch in the bearing with the groove in the head (see Figure 5).
- d. Using an arbor press, press the bearing into the head in one continuous motion, until it is flush with the inside face of the head or slightly recessed (.015" maximum).
NOTE: Ensure the bearing does not become misaligned during the pressing motion. Starting and stopping the pressing motion may result in a cracked bearing.

2. Reassemble the **OUTBOARD** side of the pump first:
 - For a **CLOCKWISE** rotation pump, position the pump cylinder with the **INTAKE** port to the **left**.
 - For a **COUNTERCLOCKWISE** rotation pump, position the pump cylinder with the **INTAKE** port to the **right**.
3. Apply a small amount of quality O-ring lubricant on a new head O-ring (72), and install in the groove on the inside face of the outboard head (23).

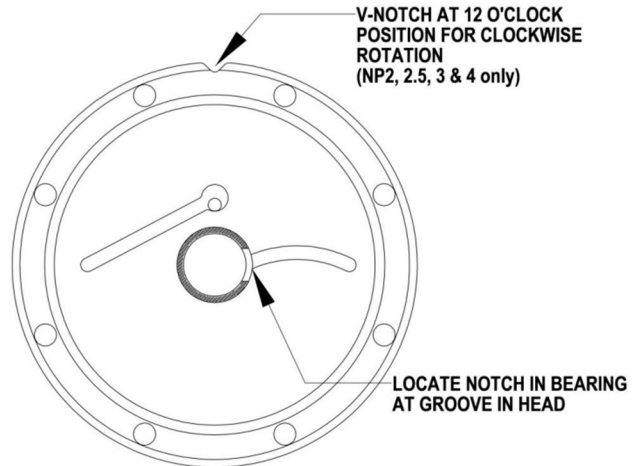

Figure 5 – Bearing Location

4. For NP1.5: Place **INTAKE** marking on outboard head towards **INTAKE** of pump. **NOTE:** V-notch location does not apply to this model.
NP2, 2.5,3 AND 4: For clockwise (right-hand) rotation, place the outboard head (23) on the cylinder with the V-notch upward, in the 12 o'clock position. For counterclockwise (left-hand) rotation, place the outboard head (23) on the cylinder with the V-notch downward, in the 6 o'clock position.
5. Install the head capscrews (21) and uniformly tighten; torque per the Bolt Torque Table.
6. Install a new bearing cover O-ring (26) and attach the bearing cover (27) to the outboard head. Install and uniformly tighten the bearing cover capscrews (28); torque per the Bolt Torque Table.

BOLT TORQUE TABLE

Model	Head Capscrew		Bearing Cover Capscrew	
	Size	Torque ft-lb (Nm)	Size	Torque ft-lb (Nm)
NP1.5	3/8"	25 (34)	5/16"	15 (20)
NP(H)2	3/8"	25 (34)	3/8"	25 (34)
NP(H)2.5	3/8"	25 (34)	3/8"	25 (34)
NP(H)3	3/8"	25 (34)	3/8"	25 (34)
NP(H)4	1/2"	58 (79)	5/8"	115 (156)

7. Turn the pump around and begin assembly on the opposite, inboard end.

MAINTENANCE

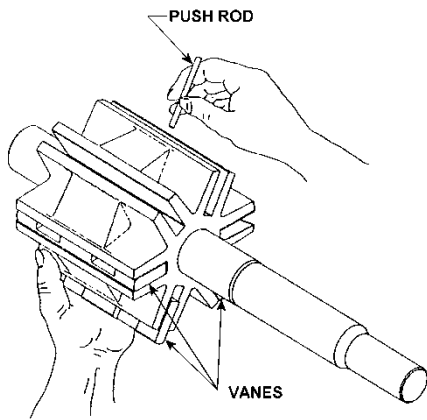

(1.5" and 2" models have only four vanes)

Figure 6 – Push Rod Installation

8. Remove the vanes and push rods from the rotor and shaft assembly and inspect for wear or damage.
 - a. Insert the vanes (14) into the bottom rotor slots with the rounded edges facing outward, and the relief grooves facing in the direction of rotation. (Refer to Figure 4.)
 - b. Hold the vanes in place while inserting the push rods (77) from the top, as shown in Figure 6.
 - c. While holding the vanes in place, carefully slide the non-driven end (shorter end) of the pump shaft into the open end of the pump cylinder and into the installed outboard head.
 - d. Install the remaining vanes into the top slots of the rotor with the relief grooves facing in the direction of rotation and the rounded edges outward.

9. Install the inboard head (20) as instructed previously in steps 3 through 6.

10. PACKING AND PACKING FOLLOWER

When necessary to re-pack, use a full set of new packing rings. Packing is furnished in sets with the correct number of rings. Never add new rings to an old set of packing.

- a. Insert the pack washer (58) into the stuffing box of the inboard head (20).
- b. Insert each of the packing rings (19) separately into the stuffing box, staggering the split joints 180 degrees, so that they are not overlapping or near the joint of the preceding ring. Use the packing follower to properly seat each ring after placement.
- c. After all of the packing rings are in place, slide the packing follower (75) against the packing. Install and hand-tighten the stud nuts (18) evenly.

NOTE: Adjustment to the packing follower should be made after the running the pump for 10 to 15 minutes (see "Packing Adjustment").

11. PACKING ADJUSTMENT

It is important that the packing be properly adjusted to prevent overheating.

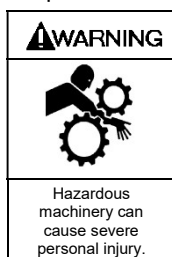

Failure to stop the pump before adjusting the shaft packing can cause severe personal injury

Hazardous machinery can cause severe personal injury.

- a. While the liquid is being pumped, check for leakage from the stuffing box. If necessary, **STOP** the pump and uniformly tighten the packing follower stud nuts (18) 1/4 turn at a time to reduce leakage.
- b. Restart the pump and check the stuffing box temperature several minutes after each adjustment for signs of overheating.
- c. Repeat steps a and b until leakage is controlled, and no excess heat develops.
- d. Check the packing again after 20 to 30 minutes of running the pump, and readjust, if necessary.

NOTE: Some leakage is desirable to lubricate the packing, but in some cases it is unacceptable, depending on the application. A commercial mechanical seal should be used for applications requiring minimal shaft leakage.

12. OPTIONAL LIP SEAL ASSEMBLY

- a. Insert the wave spring (152D) into the stuffing box of the inboard head.
- b. Lightly grease the inboard shaft to facilitate lip seal installation. With the lip seal spring facing the pump, slide the lip seal assembly (152) into the stuffing box, against the wave spring.
- c. Install the seal follower (75) against the lip seal assembly. Install and tighten the follower capscrews (16).

NOTE: When installed properly, lip seals should require no adjustment.

13. COMMERCIAL MECHANICAL SEAL

On pumps equipped with a commercial mechanical seal, refer to the separate literature accompanying the mechanical seal for installation instructions.

14. RELIEF VALVE ASSEMBLY

- a. Insert the valve (9) into the relief valve body (6) with the fluted end inward.
- b. Install the relief valve spring (8) and spring guide (7) (and valve collar (9A) on the NP2.5) against the valve.
- c. Attach a new relief valve gasket (10) and the valve cover (4) on the relief valve body (6).
- d. Screw the relief valve adjusting screw (2) into the valve cover until it makes contact with the spring guide (7).
- e. Install the relief valve cap (1) and gasket (88) after the relief valve has been precisely adjusted.

NOTICE:

The relief valve setting MUST be tested and adjusted more precisely before putting the pump into service. Refer to "Relief Valve Setting and Adjustment"

15. Reinstall coupling, shaft key, and coupling guards.

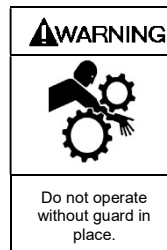

Operation without guards in place can cause serious personal injury, major property damage, or death.

15. Refer to "Pre-Start Up Check List" and "Start Up Procedures" sections of this manual prior to pump operation.

PUMP TROUBLESHOOTING

NOTICE:

Maintenance shall be performed by qualified technicians only,
following the appropriate procedures and warnings as presented in this manual.

SYMPTOM	PROBABLE CAUSE
Pump Not Priming	<ol style="list-style-type: none"> 1. Pump not wetted. 2. Suction valve closed. 3. Air leaks in the suction line. 4. Strainer clogged. 5. Suction line or valves clogged or too restrictive. 6. Wrong rotation on motor. 7. Broken drive train. 8. Pump vapor-locked. 9. Pump speed too low for priming. 10. Worn Vanes.
Reduced Capacity	<ol style="list-style-type: none"> 1. Suction valves not fully open. 2. Air leaks in the suction line. 3. Excessive restriction in the suction line (i.e.: undersized piping, too many elbows & fittings, clogged strainer, etc.). 4. Damaged or worn parts. 5. Excessive restriction in discharge line causing partial flow through the relief valve. 6. Relief Valve worn, set too low, or not seating properly. 7. Vanes installed incorrectly (see "Vane Replacement").
Noise	<ol style="list-style-type: none"> 1. Excessive vacuum on the pump due to: <ol style="list-style-type: none"> a. Undersized or restricted fittings in the suction line. b. Pump speed too fast for the viscosity or volatility of the liquid. c. Pump too far from fluid source. 2. Running the pump for extended periods with a closed discharge line. 3. Misalignment of the pump. 4. Baseplate not securely mounted. 5. Sleeve Bearings (bushings) worn or damaged. 6. Vibration from improperly anchored piping. 7. Bent shaft, or drive coupling misaligned. 8. Excessively worn rotor. 9. Malfunctioning valve in the system. 10. Insufficient oil in the gear reducer. 11. Damaged vanes (see following category).
Damaged Vanes	<ol style="list-style-type: none"> 1. Foreign objects entering the pump. 2. Running the pump dry for extended periods of time. 3. Cavitation. 4. Viscosity too high for the vanes and /or the pump speed. 5. Incompatibility with the liquids pumped. 6. Excessive heat. 7. Worn or bent push rods, or worn push rod holes. 8. Settled or solidified material in the pump at start-up. 9. Hydraulic hammer - pressure spikes. 10. Vanes installed incorrectly (see "Vane Replacement").
Broken Shaft	<ol style="list-style-type: none"> 1. Foreign objects entering the pump. 2. Viscosity too high for the pump speed. 3. Relief valve not opening. 4. Hydraulic hammer - pressure spikes. 5. Pump/driver misalignment. 6. Overtightened V-belts, if equipped. 7. Excessively worn vanes or vane slots. 8. Settled or solidified material in the pump at start-up.

PUMP TROUBLESHOOTING ...Continued

SYMPTOM	PROBABLE CAUSE
Overload on Motor	<ol style="list-style-type: none"> 1. Horsepower of motor not sufficient for application. 2. Improper wire size or wiring. 3. Misalignment. 4. Excessive viscosity, pressure or speed. 5. Faulty or worn sleeve bearings (bushings). 6. Rotor rubbing into head. 7. Excessively tight packing (see "Packing Adjustment"). 8. Unevenly tightened stud nuts, causing shaft interference with packing follower.
Mechanical Seal Leakage (if equipped)	<ol style="list-style-type: none"> 1. Seal Rings/O-rings not compatible with the liquids pumped. 2. Seal Rings/O-rings nicked, cut or twisted. 3. Shaft at seal area damaged, worn or dirty. 4. Excessive cavitation. 5. Mechanical seal faces cracked, scratched, pitted or dirty. 6. Pump sleeve bearings worn excessively. <p>NOTE: Consult commercial mechanical seal manufacturer for more information on mechanical seal troubleshooting.</p>

AFFF SERVICE PUMPS – Special Notes

NOTICE:

Design and materials of construction should be suitable for use with the type of foam concentrate to minimize corrosion, foaming, or sticking

NOTICE:

Blackmer NP pumps are not approved for use in systems where automatic system pressure balance exceeds 200 psi, 13.79 bar (175 psi, 12.07 bar for the NP4, NPH4).

DESCRIPTION

AFFF pumps were previously listed as FFNP models. They are now NP pumps with specific options:

- Duravanes (1.5" – 3")
- Laminate Vanes (4")
- Lip Seal
- Corrosion Resistant RV
- Stainless Steel 200 psi spring
- Buna-N O-Rings
- Casing Drain

TABLE 1 – TECHNICAL DATA

	1.5", 2", 2.5", 3"	4"
Maximum Differential Pressure	200 psi (13.79 Bar)	175 psi (12.07 Bar)
Maximum Working Pressure	220 psi (15.17 Bar)	195 psi (13.44 Bar)

LOCATION AND PIPING

NOTICE:

A system pressure control device, in addition to the pump relief valve, is required.

OPERATION

NOTICE:

The pump must be tested, for a ten minute period, every 30 days. During this activity, the pump discharge must be recirculated through a bypass system. Do not operate the pump against a closed discharge.

An electrical time clock is recommended to record elapsed operating time. Refer to the 'Scheduled Maintenance - Pump' section.

PUMP RELIEF VALVE

NOTICE:

The pump's internal relief valve is designed to protect only the pump from excessive pressure and must not be used as a system pressure relief valve. Foam system pressure must be controlled by a separate bypass pressure control valve which returns bypassed fluid to the foam storage tank.

SCHEDULED MAINTENANCE - PUMP

1. Pump MUST be disassembled and checked after each ten hours of system trial operation, or five years, whichever occurs sooner. The heads (20 & 23), cylinder (12), bushing (24) and vanes (14) MUST be inspected for wear. Replacement of worn parts is required. Inspect the rotor and shaft for wear or corrosion. If rotor & shaft indicates wear, scaling, flaking rust particles or cracking, replacement is required.
2. If during operation of the system the contents of the foam concentrate tank has been depleted OR there is reason to believe the pump has run dry, the pump MUST be completely disassembled and carefully inspected for damage or wear. The heads (20 & 23), cylinder (12), bushing (24) and vanes (14) MUST be inspected for wear. Replacement of worn parts is required. Inspect the rotor and shaft for wear or corrosion. If rotor & shaft indicates wear, scaling, flaking rust particles or cracking, replacement is required.

Blackmer[®]

1809 Century Avenue, Grand Rapids, Michigan 49503-1530 U.S.A.
Telephone: (616) 241-1611 • Fax: (616) 241-3752
E-mail: blackmer@blackmer.com • Internet Address: www.blackmer.com