

# BLACKMER LIQUEFIED GAS PUMPS

FOR LP-GAS AND NH<sub>3</sub> SERVICE, TRUCK AND BASE MOUNTED  
INSTALLATION OPERATION AND MAINTENANCE INSTRUCTIONS

MODEL: LGL3021A

960439

INSTRUCTIONS NO. 501-L00

Section	501
Effective	Jan 2019
Replaces	Jun 2016



## TABLE OF CONTENTS

	Page
<b>SAFETY DATA</b> .....	1
<b>PUMP DATA</b>	
Pump Identification.....	2
Technical Data .....	2
Initial Pump Start Up Information .....	2
<b>GENERAL INSTALLATION AND OPERATION</b>	
Welded Connections .....	3
Pre-Installation Cleaning .....	3
Location and Piping.....	3
Pump Relief Valve and Bypass Valve .....	4
Check Valves .....	4
Pump Rotation .....	4
<b>MOTOR DRIVEN PUMPS</b>	
Pump Mounting .....	4
Coupling Alignment .....	5
V-Belt Drive .....	5
V-Belt Disassembly .....	5
Pre-Start Up Check List .....	6
Start Up Procedures.....	6
<b>TRUCK MOUNTED PUMPS</b>	
Truck Mounting .....	6
Pump Drive .....	6
Hydraulic Drive .....	7
Pre-Start Up Check List .....	7
Start Up Procedures.....	7
Pump Speed .....	8
<b>MAINTENANCE</b>	
Strainers.....	8
Lubrication.....	8
Vane Replacement.....	9
Pump Disassembly .....	9
Pump Assembly .....	10
<b>TROUBLE SHOOTING</b> .....	11

**NOTE:** Numbers in parentheses following individual parts indicate reference numbers on Blackmer Parts List 501-L01

Blackmer pump manuals and parts lists may be obtained from Blackmer's website ([www.blackmer.com](http://www.blackmer.com)) or by contacting Blackmer Customer Service.

## SAFETY DATA



This is a **SAFETY ALERT SYMBOL**.

When you see this symbol on the product, or in the manual, look for one of the following signal words and be alert to the potential for personal injury, death or major property damage



Warns of hazards that **WILL** cause serious personal injury, death or major property damage.



Warns of hazards that **CAN** cause serious personal injury, death or major property damage.



Warns of hazards that **CAN** cause personal injury or property damage.

### NOTICE:

Indicates special instructions which are very important and must be followed.

### NOTICE:

Blackmer liquefied gas pumps **MUST** only be installed in systems which have been designed by qualified engineering personnel. The system **MUST** conform to all applicable local and national regulations and safety standards.

This manual is intended to assist in the installation and operation of the Blackmer liquefied gas pumps, and **MUST** be kept with the pump.

Blackmer liquefied gas pump service shall be performed by qualified technicians **ONLY**. Service shall conform to all applicable local and national regulations and safety standards.

Thoroughly review this manual, all Instructions and hazard warnings, **BEFORE** performing any work on the Blackmer liquefied gas pumps.

Maintain **ALL** system and Blackmer liquefied gas pump operation and hazard warning decals.

## SAFETY DATA

**⚠ WARNING**



Hazardous machinery can cause serious personal injury.

Failure to set the vehicle emergency brake and chock wheels before performing service can cause severe personal injury or property damage

**⚠ WARNING**



Hazardous voltage. Can shock, burn or cause death.

Failure to disconnect and lockout electrical power before attempting maintenance can cause shock, burns or death

**⚠ WARNING**



Hazardous machinery can cause serious personal injury.

Failure to disconnect and lockout electrical power or engine drive before attempting maintenance can cause severe personal injury or death

**⚠ WARNING**



Do not operate without guard in place

Operation without guards in place can cause serious personal injury, major property damage, or death.

**⚠ WARNING**



Hazardous pressure can cause serious personal injury or property damage

Disconnecting fluid or pressure containment components during pump operation can cause serious personal injury or property damage.

**⚠ WARNING**



Hazardous pressure can cause serious personal injury or property damage

Failure to relieve system pressure prior to performing pump service can cause serious personal injury or property damage. Systems with meters will still be pressurized even after the hose is emptied

**⚠ WARNING**



Hazardous or toxic fluids can cause serious injury.

If pumping hazardous or toxic fluids, system must be flushed and decontaminated, inside and out, prior to performing service or maintenance

## PUMP DATA

### PUMP IDENTIFICATION

A pump Identification tag, containing the pump serial number, I.D. number, and model designation, is attached to each pump. It is recommended that the data from this tag be recorded and filed for future reference. If replacement parts are needed, or if information pertaining to the pump is required, this data must be furnished to a Blackmer representative.

#### TECHNICAL DATA

Models	LGL3021A
Torque required @100 psi (6.9 bar)	89 lbs ft (121 Nm)
Maximum Pump Speed @ Max. Differential Press.	800 RPM
Maximum Differential Pressure	125 psi (8.62 Bar)
Maximum Operating Temperature	240°F (115°C)
Maximum Working Pressure	350 PSI (24.1 Bar)

- Technical Data is for standard materials of construction. Consult Blackmer Material Specs for optional materials of construction.
- These pumps are listed by Underwriters' Laboratories for liquefied petroleum gas and NH<sub>3</sub> service.

#### INITIAL PUMP START UP INFORMATION

<b>Model No.:</b> _____
<b>Serial No.:</b> _____
<b>ID No.:</b> _____
<b>Date of Installation:</b> _____
<b>Inlet Gauge Reading:</b> _____
<b>Discharge Gauge Reading:</b> _____
<b>Flow Rate:</b> _____

# GENERAL INSTALLATION AND OPERATION

## NOTICE:

Blackmer pumps must only be installed in systems designed by qualified engineering personnel. System design must conform with all applicable regulations and codes and provide warning of all system hazards.

## NOTICE:

This pump shall be installed in accordance with the requirements of NFPA 58, all applicable local, state and national regulations.

## WELDED CONNECTIONS

### NOTICE:

Pumps with welded connections contain three non-metallic O-ring seals that will be damaged if welding is done with these O-rings installed.

Prior to welding the piping, remove the O-rings from under the inlet flange, outlet flange and relief valve cover as indicated in Figure 1.

Reinstall the inlet and outlet flanges. Weld the piping to the the inlet and outlet flanges. After the welding is complete, reinstall the O-rings.

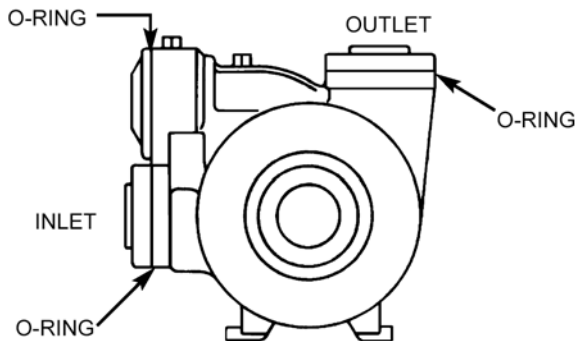

Figure 1

## PRE-INSTALLATION CLEANING

### NOTICE:

New pumps contain residual test fluid and rust inhibitor. If necessary, flush pump prior to use.

Foreign matter entering the pump WILL cause extensive damage. The supply tank and intake piping MUST be cleaned and flushed prior to pump installation and operation.

## LOCATION AND PIPING

Pump life and performance will be significantly reduced when installed in an improperly designed system. Before starting the layout and installation of the piping system, review the following suggestions:

1. Locate the pump as near as possible to the source of supply to avoid excessive inlet pipe friction.
2. The inlet piping and fittings should be at least as large as the intake port on the pump. Slope the pipe downward to the pump, and do not install any upward loops. Minimize the number of intake line fittings and eliminate restrictions such as sharp bends; globe valves, unnecessary elbows, and undersized strainers.
3. A strainer must be installed in the inlet line to protect the pump from foreign matter. Locate the strainer at least 24" (0.6m) from the pump. Strainers must have a net open area of at least four times the area of the intake piping, and must be cleaned regularly to avoid pump starvation.
4. The intake and discharge piping system must be free of all leaks.
5. Expansion joints, placed at least 36" (0.9m) from the pump, will compensate for expansion and contraction of the pipes. Contact the flexible connector/hose manufacturer for required maintenance/care and design assistance in their use.
6. ALL piping and fittings MUST be properly supported to prevent any piping loads from being placed on the pump.
7. Check alignment of pipes to pump to avoid strains which might later cause misalignment. See Figure 2. Unbolt flanges or break union joints. Pipes must not spring away or drop down. After the pump has been in operation for a week or two, completely recheck alignment.

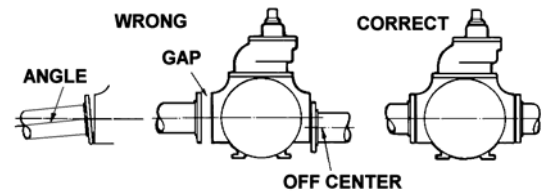

Figure 2

8. Install pressure gauges in the NPT ports provided in the pump casing to check pump performance at start up.
9. The use of a 1.5" or 2" vapor return line will speed up delivery by preventing pressure build up at the receiving tank and pressure reduction in the supply tank.
10. Keeping the liquefied gas systems full of liquid, even when idle, will keep the O-rings from changing shape, shrinking or super cooling. Evaporation of liquefied gas leaves an abrasive powder on the surface which can cause wear to the pump, meter, and seals.

# GENERAL INSTALLATION AND OPERATION

## PUMP RELIEF VALVE AND BYPASS VALVE

### NOTICE:

The pump internal relief valve is designed to protect the pump from excessive pressure and must not be used as a system pressure control valve.

For ALL liquefied gas applications, install an external bypass valve, and any necessary piping, back to the tank. External Bypass Valves are integral to the performance and operation of liquefied gas pumps and are included in the boundary / jurisdiction of the pump (Refer to Form 589). DO NOT pipe the bypass valve back to the intake line. The setting on the external bypass valve must be at least 25 psi (1.7 bar) lower than the pump internal relief valve setting. The valve and piping must be of adequate size to accommodate the full flow from the pump when the discharge line is closed. The non-adjustable pump internal relief valve is factory set at approximately 150 PSI (10.3 bar).

The 'Alternate Discharge to Storage Tank' line and manual valve may be used to unload transports without pumps into the storage tank. The manual valve in this line must remain closed during all other operations.

Refer to Blackmer Bypass Valve Installation and Maintenance Instructions for bypass valve settings and adjustments.

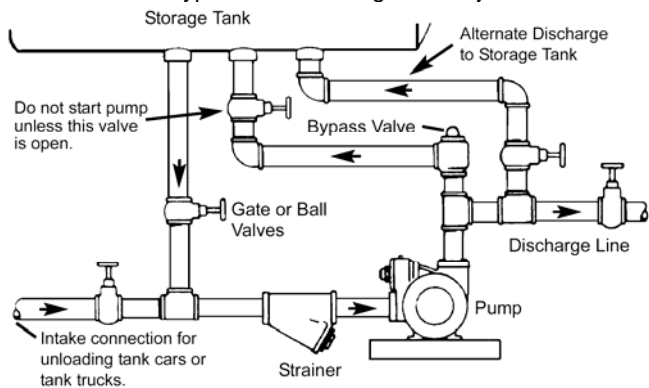

Figure 3 – Bypass Valve Mounting

## CHECK VALVES

The use of check valves or foot valves in the supply tank is not recommended with self-priming, positive displacement pumps.

If the possibility of liquid backflow exists when the pump is off, a check valve in the pump discharge piping is recommended because the pump can motor in the reverse rotation and create undue stress on all attached components. Never start a pump when it is rotating in the reverse rotation as the added starting torque can damage the pump and related equipment.

## PUMP ROTATION

### NOTICE:

Confirm correct pump rotation by checking the pump rotation arrows respective to pump driver rotation.

Blackmer LGL3021 pump model has a double ended rotor and shaft, enabling them to be driven from either shaft end. To change rotation, rotate the pump 180 degrees so that the opposite shaft becomes the driven shaft. The shaft protector (186) MUST be mounted over the non-driven shaft.

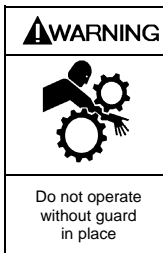

**Operation without guards in place can cause serious personal injury, major property damage, or death.**

Do not operate without guard in place

## MOTOR DRIVEN PUMPS

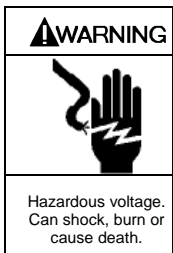

- ⚠ **Install, ground and wire to local and National Electrical Code requirements.**
- ⚠ **Install an all-leg disconnect switch near the unit motor.**
- ⚠ **Disconnect and lockout electrical power before installation or service**
- ⚠ **Electrical supply MUST match motor nameplate specifications.**

- ⚠ **Motors equipped with thermal protection automatically disconnect motor electrical circuit when overload exists. Motor can start unexpectedly and without warning.**

### NOTICE:

Consult the "General Installation and Operation" section of this manual for system information.

## PUMP MOUNTING

Permanently mount the unit by securing the base plate with adequately sized anchor bolts to a level concrete floor following recommended industry standards (See Figure 4). A solid foundation will reduce system noise and vibration, and

will improve pump performance. Refer to ANSI/HI standards or a suitable pump handbook for information on typical pump mounting and foundations. Check coupling alignment after pump and base assembly is secured to the foundation.

Figure 4

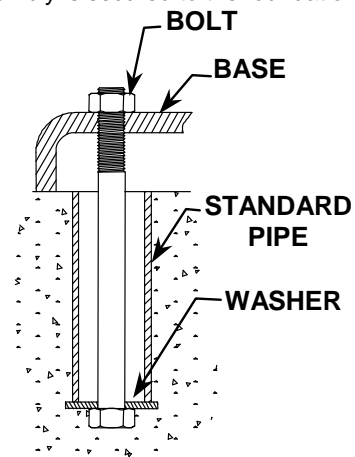

# MOTOR DRIVEN PUMPS

## COUPLING ALIGNMENT

The pump must be directly coupled to a gear reducer and/or driver with a flexible coupling. Verify coupling alignment after installation of new or rebuilt pumps. Both angular and parallel coupling alignment **MUST** be maintained between the pump, gear, motor, etc. in accordance with manufacturer's instructions. See Figure 5.

1. Parallel alignment: The use of a laser alignment tool or dial indicator is preferred. If a laser alignment tool or dial indicator is not available, use a straightedge. Turn both shafts by hand, checking the reading through one complete revolution. Maximum offset must be less than .0005" (0.127 mm).
2. Angular alignment: Insert a feeler gauge between the coupling halves. Check the spacing at 90° increments around the coupling (four checkpoints). Maximum variation must not exceed 0.005" (0.127 mm). Some laser alignment tools will check angular alignment as well.
3. Replace the coupling guards after setting alignment.

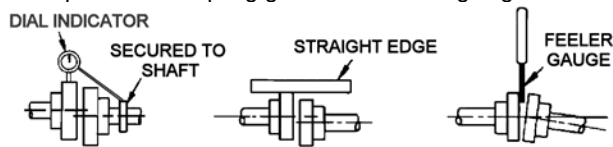

Figure 5 – Coupling Alignment

## V-BELT DRIVE

For installation of Blackmer V-belt units, first mount the pump and the motor base to the unit base. Do not fully tighten the motor mounting bolts until properly installing and adjusting the belts as follows:

1. Wipe the cone surface of the pump QD hub (152A) and the inside of the pump sheave hub with a clean cloth moistened with a light grade of machine oil. This will allow for a more uniform draw and prevent the cone surfaces from "freezing" before being tightened.
2. With the pump shaft key (35) in place, align the key seat and slide the QD hub (152A) on the shaft, flange end first. Slide the large end of the sheave (152) bore over the taper on the QD hub. Insert the three sheave capscrews (152G) through the clearance holes in the sheave, and start them into the tapped holes of the QD hub (152A). Repeat this procedure to assemble the motor QD hub (152E) and sheave (152D).
3. To install the belts (181), shorten the center distance of the drive by moving the motor towards the pump, until the belts can be put on the sheaves (152 & 152D) without forcing.
4. Align the sheaves so that the faces are parallel, then snug up the sheave capscrews (152C & G).

Figure 6 – V-Belt Adjustment

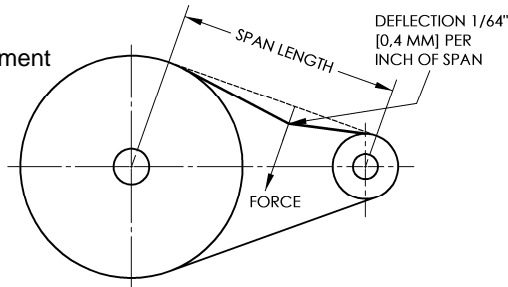

5. Measure the span length as shown in Figure 6.
6. Adjust the motor base (183) and apply a specified force (see Table 1) against the belt, at the center of the span, so that the belt is deflected 1/64 inch (0.04 mm) for every inch (25.4 mm) of span. For example, the deflection of a 20 inch (508 mm) span would be 20/64 or 5/16 inch (7.9 mm). Refer to Table 1 for the deflection force of a properly tensioned drive. A new set of belts should be initially tensioned to the upper limit.

SMALL SHEAVE OUTSIDE DIAMETER	BELT DEFLECTION FORCE	
	Minimum	Maximum
2.5" to 4.5" (63 mm to 114 mm)	3.0 lbs (1.4 kgs)	4.75 lbs (2.2 kgs)
4.75" to 7.0" (121 mm to 178 mm)	4.0 lbs (1.8 kgs)	6.0 lbs (2.7 kgs)

Table 1 - Deflection Force Per Belt

7. Check again to ensure the sheaves (152 & 152D) are parallel, then tighten the sheave capscrews (152C & 152G), the motor mounting nuts (183B) and the adjusting screw locknut (183B).
8. Assemble the belt guard (182) and the belt guard brace (182A) to the unit base (32).

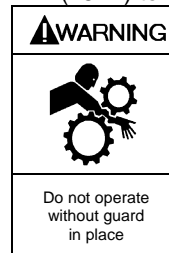

**Operation without guards in place can cause serious personal injury, major property damage, or death.**

Do not operate without guard in place

9. Check the belt tension after 24-48 hours of operating. Recheck the tension periodically and tighten the belts as required. **DO NOT** overtighten belts. Inspect belts periodically for signs of excessive wear, and replace as required.

## V-BELT DISASSEMBLY

1. Remove the belt guard (182) and the guard base (182A). Loosen the adjusting screw locknut (183B) on the motor base (183) and the motor mounting nuts.
2. Ease the tension on the belts (181) by moving the motor towards the pump to shorten the center distance of the drive. Remove the belts by sliding them over the sheaves (152 & 152D). **DO NOT** force the belts over the grooves.
3. To remove the sheave from the hub, first remove the three sheave capscrews (152C or 152G). Then screw two of the capscrews into the threaded holes in the sheave hub (152A or E). If the cone grip is hard to break loose, tap the end of the shaft or the QD hub with soft-faced mallet while maintaining pressure on the screw.
4. The QD hub should slide smoothly off the shaft. If it is tight on the shaft, gently pry it loose with a screwdriver or a small wedge placed in the split part of the flange.

**Refer to Blackmer V-Belt Parts List and Instructions for V-belt drive and guard part numbers.**

# MOTOR DRIVEN PUMPS

## PRE-START UP CHECK LIST

1. Inspect complete piping system and supports to ensure that no piping loads are being placed on the pump.
2. Verify proper coupling or V-belt alignment.
3. Install pressure gauges in the 1/4" NPT intake and discharge ports located on the pump casing to check pump performance after start-up.
4. Ensure all valves and fittings in piping system are in the start-up or operating positions.
5. Jog the pump motor to verify proper pump rotation.

## START UP PROCEDURES

### NOTICE:

Consult the "Troubleshooting" sections of this manual if difficulties during start up are experienced.

1. SLOWLY build pressure in the pump.
2. Start the motor.
3. Check pressure gauges to ensure the system is operating within expected parameters. Record the gauge readings in the "Initial Start Up Information" section of this manual for future reference.
4. Inspect piping, fittings, and associated system equipment for leaks, noise, vibration and overheating.

5. Check the flow rate to ensure the pump is operating within the expected parameters. Record flow rate in the "Initial Start Up" section of this manual.
6. Close the discharge valve and check the differential pressure across the pump. Pressure must not exceed the pressure setting of the external bypass valve.
7. With the discharge valve still closed, momentarily close the manual shut-off valve in the bypass return line to check the pump internal relief valve. The differential pressure will be approximately 150 and 170 PSI (10.3 and 11.7 bar).
8. The external bypass valve must always be set at least 25 PSI (1.7 bar) lower than the internal pump relief valve.  
NOTE: The normal operating pressure must be at least 5 - 15 PSI (0.3 -1.0 bar) less than the external bypass valve setting. Pump speeds which result in higher pressures (nearing the valve setting) forces the liquid to recirculate, creating excessive wear on the pump and equipment.

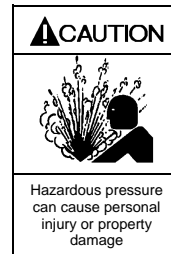

**Pumps operating against a closed valve can cause system failure, personal injury and property damage**

---

# TRUCK MOUNTED PUMPS



**Failure to set the vehicle emergency brake and chock wheels before performing service can cause severe personal injury or property damage.**

### NOTICE:

Consult the "General Installation and Operation" section of this manual for system information.

## TRUCK MOUNTING

The pump will operate satisfactorily in any position. When locating the pump on a tank, safety should be the first consideration. The pump can be bolted to the truck frame or on a saddle hung below the frame, and MUST be adequately supported.

## PUMP DRIVE

The pump may be driven by a power take-off through universal joints. When using universal joints, a splined slip joint, properly lubricated, must be used on the connecting jack shaft to prevent end thrust on the pump shaft. It is very important to install a proper drive line to avoid excessive wear, vibration and noise (see Fig. 7 and Table 2).

General guidelines to follow for proper pump drive:

1. Do not use square slip joints.
2. Use the least number of jack shafts as is practical.
3. Use an even number of universal joints.
4. The pump shaft and power take-off shaft must be parallel in all respects. Use an angular level measuring device to ensure the PTO and pump shaft are parallel to each other. If necessary, the pump can be shimmed to correct any misalignment. The PTO shaft coming off at the transmission does not need to be perfectly horizontal as long as the pump is shimmed to have its shaft parallel in all respects to the PTO shaft.
5. The yokes of the universals at both ends of the jack shaft must be parallel and in phase.
6. The maximum recommended angle between the jack shaft and the pump shaft is 15 degrees. See Table 2.

Failure to follow any of these guidelines may result in a gallop or uneven turning of the pump rotor, which will in turn cause a surging vibration to the liquid stream and piping system. Contact the supplier of the drive line components for specific design assistance.

# TRUCK MOUNTED PUMPS

**WARNING**



Do not operate without guard in place

A drive shaft guard between the pto and pump must be provided to prevent personal injury, property damage, or death.

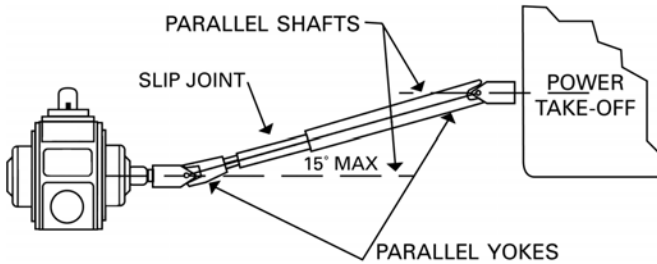

Figure 7 – Pump Drive

**Note: A Drive Shaft Guard between the pump and the PTO MUST be provided. (Not Shown)**

Angle of Drive Shaft		
1° through 5°	6° through 10°	11° through 15°
Very good	Good	Fair

Table 2

## HYDRAULIC DRIVE

Truck mounted pumps may also be driven hydraulically. Hydraulic motors must be well supported with their shafts parallel to the pump shaft in all respects. Blackmer provides an optional close-coupled hydraulic motor adapter. The adapter provides for straight alignment of a hydraulic motor drive through a solid coupling connected to a straight key pump shaft. This coupling connection requires grease lubrication every three months at minimum. See the "Lubrication" section of this manual.

**WARNING**



Do not operate without guard in place

Operation without shaft protector can cause serious personal injury, major property damage, or death.

## PRE-START UP CHECK LIST

1. Check the alignment of the pipes to the pump. Pipes must be supported so that they do not spring away or drop down when the pump flanges or union joints are disconnected.
2. Install pressure gauges in the 1/4" NPT ports located on the pump casing. These can be used to check the actual inlet and discharge conditions after pump start-up.
3. Inspect complete piping system to ensure that no piping loads are being placed on the pump.
4. Secure appropriate hose connections.

## START UP PROCEDURES

### NOTICE:

Consult the "General Pump Troubleshooting" section of this manual if difficulties during start up are experienced.

**CAUTION**



Hazardous pressure can cause personal injury or property damage

Pumps operating against a closed valve can cause system failure, personal injury and property damage

1. Open the shut-off valve in the bypass return line.
2. If the tank outlet valve is:
  - a. **Lever Operated** - Pull the control knob all the way out. Manually check the lever under the truck to see that it is in the completely OPEN position.
  - b. **Discharge Pressure Operated** - Keep the discharge line valve closed. When pump is started, it will build up enough pressure to open the tank outlet valve. NOTE: This type of valve usually requires approximately 20 PSI (1.4 bar) differential pressure to open and approximately 15 PSI (1.0 bar) differential pressure to keep it open. If the piping is quite large, it may be necessary to restrict the discharge line shut-off valve in order to maintain sufficient pressure to keep the tank outlet valve open.
3. Start the pump. Confirm proper pump rotation by checking the pump rotation arrows.
4. Check the pump speed. Pump speed must never exceed the recommended maximum. See "Technical Data" section of this manual.
5. Check the pressure gauges to ensure the system is operating within expected parameters. Record the gauge readings in the "Initial Start Up Information" section of this manual for future reference.
6. Inspect piping, fittings, and associated system equipment for leaks, noise, vibration and overheating.
7. Check the flow rate to ensure the pump is operating within the expected parameters. Record the flow rate in the "Initial Start Up Information" section of this manual for future reference.
8. Close the discharge valve and check the differential pressure across the pump. It must not exceed the pressure setting of the external bypass valve.
9. With the discharge valve still closed, momentarily close the manual shut-off valve in the bypass return line to check the internal pump relief valve. The differential pressure should be between 150 and 170 PSI (10.3 and 11.7 bar).
10. The external bypass valve must always be set at least 25 PSI (1.7 bar) lower than the pump internal relief valve. NOTE: The normal operating pressure must be at least 5 - 15 PSI (0.3 - 1.0 bar) less than the external bypass valve setting. Pump speeds which result in higher pressures (nearing the valve setting) forces the liquid to recirculate, creating excessive wear on the pump and equipment.

# TRUCK MOUNTED PUMPS

## PUMP SPEED

PTO and hydraulically driven units MUST contain speed control devices to prevent pump speeds above the maximum RPM specifications, regardless of the truck engine unloading speeds. Should fluid delivery be appreciably less than expected, see the "General Pump Troubleshooting" section.

## MAINTENANCE

**WARNING**



Hazardous machinery can cause serious personal injury.

Failure to set the vehicle emergency brake and chock wheels before performing service can cause severe personal injury or property damage

**WARNING**



Hazardous machinery can cause serious personal injury.

Failure to disconnect and lockout electrical power or engine drive before attempting maintenance can cause severe personal injury or death

**WARNING**



Hazardous pressure can cause personal injury or property damage

Disconnecting fluid or pressure containment components during pump operation can cause serious personal injury or property damage.

**WARNING**



Hazardous voltage. Can shock, burn or cause death.

Failure to disconnect and lockout electrical power before attempting maintenance can cause shock, burns or death

**WARNING**



Hazardous pressure can cause serious personal injury or property damage

Failure to relieve system pressure prior to performing pump service can cause serious personal injury or property damage. Systems with meters will still be pressurized even after the hose is emptied

**WARNING**



Hazardous or toxic fluids can cause serious injury.

If pumping hazardous or toxic fluids, system must be flushed and decontaminated, inside and out, prior to performing service or maintenance

### NOTICE:

Maintenance shall be performed by qualified technicians only, following the appropriate procedures and warnings as presented in this manual.

## STRAINERS

Strainers must be cleaned regularly to avoid pump starvation. Schedule will depend upon the application and conditions.

## LUBRICATION

### NOTICE:

To avoid possible entanglement in moving parts do not lubricate pump bearings, hydraulic adapter coupling or any other parts while pump is running

### NOTICE:

If pumps are repainted in the field, ensure that the grease relief fittings (76A) are functioning properly after painting. Do NOT paint them closed. Remove any excess paint from the fittings.

Lubricate pump bearings and hydraulic motor couplings (if equipped) every three months at a minimum. More frequent lubrication may be required, depending on the application and the operating conditions.

### Recommended Grease:

Mobil® - Mobilgrease XHP222,  
Exxon® - Ronnex MP Grease,  
or equivalent Lithium grease.

### Greasing Procedure:

1. Remove the grease relief fittings (76A) from the bearing covers (27) or hydraulic motor adapter (135).
2. SLOWLY apply grease with a hand gun until grease begins to escape from the grease relief fitting port. Discard excess grease in accordance with the proper codes and regulations.
3. Replace the grease relief fittings (76A).

DO NOT over grease pump bearings. While it is normal for some grease to escape from the grease tell-tale hole after lubrication, excessive grease can cause mechanical seal failure. The tell-tale hole is located in the head (20) between the bearing (24) and the mechanical seal (153).



## MAINTENANCE

### VANE REPLACEMENT

#### NOTICE:

Maintenance shall be performed by qualified technicians only, following the appropriate procedures and warnings as presented in this manual.

1. Drain and relieve pressure from the pump and system as required.
2. Remove the head assembly from the outboard (non-driven) side of the pump according to steps 4 - 9 in the "Pump Disassembly" section of this manual.
3. Turn the shaft by hand until a vane (14) comes to the top (12 o'clock) position of the rotor. Remove the vane.
4. Install a new vane (14), ensuring that the rounded edge is UP, and the relief grooves are facing towards the direction of rotation. See Figure 8.
5. Repeat steps 3 and 4 until all vanes have been replaced.
6. Reassemble the pump according to the "Pump Assembly." section of this manual.

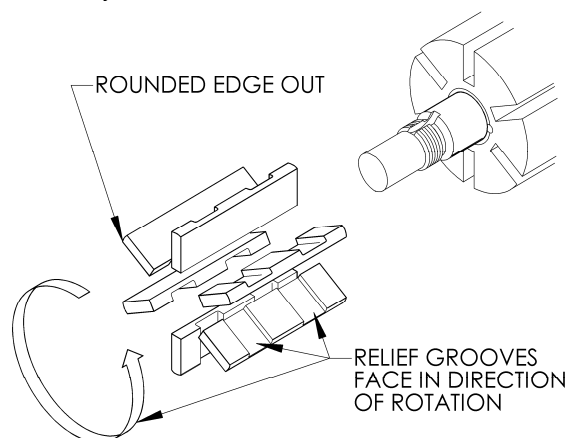

Figure 8 – Vane Installation

### PUMP DISASSEMBLY

#### NOTICE:

Follow all hazard warnings and instructions provided in the "maintenance" section of this manual.

1. Drain and relieve pressure from the pump and system as required.
2. Starting on the inboard (driven) end of the pump, clean the pump shaft thoroughly, making sure the shaft is free of nicks and burrs. This will prevent damage to the mechanical seal when the inboard head assembly is removed.
3. Remove the inboard bearing cover capscrews (28) and slide the inboard bearing cover (27) and gasket (26) off the shaft. Discard the bearing cover gasket. On the 2-inch pump models the dirt shield (123) will come off with the bearing cover.
4. Remove the outboard bearing cover capscrews (28) and slide the outboard bearing cover (27) and gasket (26) off the shaft. Discard the bearing cover gasket. On the 2-inch pump models the dirt shield (123) will come off with the bearing cover..

5. To remove locknuts and lockwashers (24A and 24B):
  - a. Bend up the engaged lockwasher tang and rotate the locknut (24A) counterclockwise to remove it from the shaft
  - b. Slide the lockwasher (24B) off the shaft. Inspect the lockwasher for damage and replace as required.
  - c. Repeat steps a and b on the opposite shaft end.
6. Remove the head capscrews (21) and carefully pry the head (20) away from the casing (12).
7. Slide the head (20) off the shaft. The head O-ring (72), bearing (24), mechanical seal stationary seat and stationary O-ring (153A & 153D) will come off with the head assembly. Remove and discard the head O-ring.
  - a. Pull the bearing (24) from the housing in the head (20).
  - b. To remove the mechanical seal stationary seat (153A), use the blunt end of a screw driver to gently push the backside of the stationary seat from the head. Place a cloth under the seal to avoid damage. Be careful not to contact the polished face of the seal during removal. Remove and discard mechanical seal stationary O-ring.
8. Carefully pull the rotating seal assembly, consisting of seal jacket (153C), rotating seal face and rotating O-ring (153B & 153E) from the shaft. Remove and discard the rotating O-ring (153E).
9. Carefully remove the disc (71).
10. Carefully pull the rotor and shaft (13) from the casing (12). While one hand is pulling the shaft, cup the other hand underneath the rotor to prevent the vanes (14) and push rods (77) from falling out. Carefully set the rotor and shaft aside for future vane replacement and reassembly.

#### NOTICE:

The rotor and shaft weighs approximately 34 pounds (15 kg). Be careful not to pinch the hand under the rotor and shaft when removing from casing.

11. Lay the pump flat with the remaining head (20) facing upward to remove the head assembly mechanical seal (153) and disc (71) from the outboard side of the pump, as instructed in steps 6 - 9 above.
12. If necessary, remove the liner (41) by tapping around the outside diameter of the liner with a hard wood drift and a hammer until it is driven from the casing (12).

## MAINTENANCE

### PUMP ASSEMBLY

Before reassembling the pump, inspect all parts for wear or damage, and replace as required. Wash out the bearing/seal recess of the head and remove any burrs or nicks from the rotor and shaft. Remove any burrs from the liner.

Reassemble the OUTBOARD side of the pump first:

1. On 2-inch pump models, apply grease to the liner key groove in the pump casing to hold the key (74) in place during liner installation. Install key in groove before starting liner (41) into pump casing (12). On 3-inch pump models, install the liner key (74) in the groove on top of the liner (41).
2. Align the liner key (74) with the pump casing keyway and start the liner (41) into the casing (12) with the slots in the liner towards the INTAKE port, and the hole pattern in the liner towards the DISCHARGE port. Uniformly tap the outer edge of the liner with a rubber mallet to fully insert into the casing. NOTE: If the liner is installed backwards, it will restrict the port openings and cause cavitation, noise and loss of capacity.
3. Place the disc (71) against the liner (41) with the seal cavity outward and disc relief hole located as shown in Figure 9.

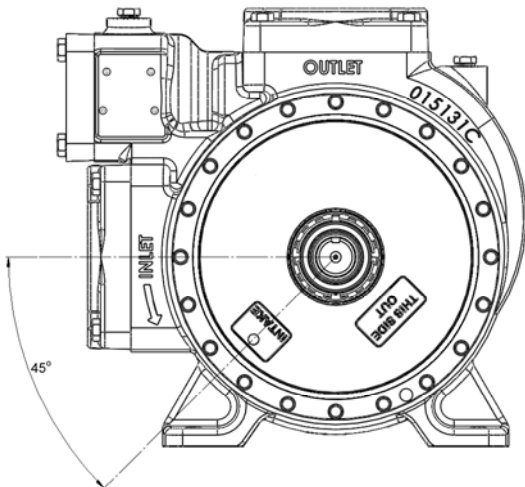

Figure 9 - Disc Relief Hole Location

4. Without installing the head O-ring or mechanical seal components, temporarily attach the outboard head (20) and bearing (24) to the casing (12). Install and hand tighten two head capscrews (21), 180 degrees apart. This head will be used to hold and align the rotor and shaft (13) while the inboard side of the pump is assembled.
5. Remove the vanes (14) and push rods (77) from the rotor and shaft assembly (13). Inspect for wear and damage, and replace as follows:
  - a. Partially install the non-driven end of the rotor and shaft (13) into the open side of the pump casing (12).
  - b. Leave part of the rotor outside of the casing (12) so that the bottom vanes (14) can be installed and held in place as the push rods (77) are installed in the push rod holes of the rotor. Insert the new vanes into the rotor slots with the rounded edges outward, and the vane relief grooves facing TOWARDS the direction of rotation. See Figure 8.

- c. After the bottom vanes and push rods are installed, insert the rotor and shaft (13) fully into the casing (12).
  - d. Install the remaining vanes (14) into the top positions of the rotor.
6. Install the disc (71) on the inboard side of the pump with the seal cavity facing outward and the disc relief hole located as shown in Figure 9.
  7. Install a new head O-ring (72) in the groove on the inside face of the head (20). Lay the O-ring flat and start in on one side of the groove, stretching ahead with the fingers, as shown in Figure 10.

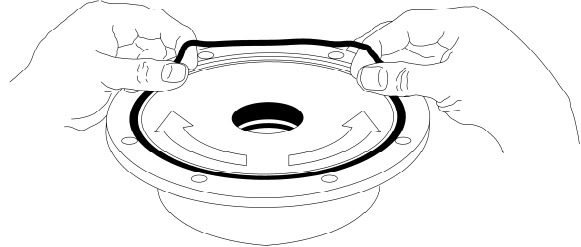

Figure 10 – Head O-ring Installation

### 8. MECHANICAL SEAL INSTALLATION

#### Rotating Assembly -

- a. Apply a small amount of motor oil on the shaft between the shaft threads and the rotor.
- b. Slide the seal jacket assembly (153C) over the shaft and into the disc cavity with the drive tangs of the jacket towards the rotor. Rotate the jacket assembly to engage the drive tangs in the rotor slots.
- c. Install a new rotating O-ring (153E) in the rotating seal face (153B). Align and insert the rotating assembly into the seal jacket with the polished face outward. Clean the polished face with a clean tissue and alcohol.

#### Stationary Seat -

- a. Apply a small amount of motor oil in the seal recess of the head (20).
  - b. Install a new stationary O-ring (153D) in the stationary seat (153A). Align the pin in the stationary seat with the slot in the head recess and push the seat fully into the seal recess with the polished face outward. Clean the polished face with a clean tissue and alcohol.
9. Carefully install the head assembly (20) over the shaft. Do not contact the end of the shaft with the polished face of the stationary seat. Rotate the head so that the drain hole (tell-tale hole), located at the back of the bearing cavity, faces downward when the pump is mounted for operation. Install and uniformly tighten four head capscrews (21) 90° apart, torquing to 30 lbs ft (40.7 Nm).
  10. Hand pack the spherical roller bearing (24) with grease. See the "Lubrication" section for recommended greases.
  11. Install the bearing (24) into the head recess. Ensure the bearing is fully and squarely seated in the head (20).
  12. Turn the pump casing around and remove the outboard head previously attached.
  13. Install the outboard head (20), mechanical seal (153) and bearing (24) as instructed in steps 6 through 11.

## MAINTENANCE

14. Rotate the shaft by hand to engage the mechanical seal drive tangs, and to test for binding or tight spots. If the rotor does not turn freely, lightly tap the rims of the heads with a soft faced mallet until the correct position is found. Install all of the remaining head capscrews (21) for each head (20) and uniformly torque to 30 lbs ft (40.7 Nm).

### 15. LOCKNUT ADJUSTMENT

It is important that the bearing locknuts (24A) and lockwashers (24B) be installed and adjusted properly. Overtightening locknuts can cause bearing failure or a broken lockwasher tang. Loose locknuts will allow the rotor to shift against the discs (71), causing wear. See Figure 11.

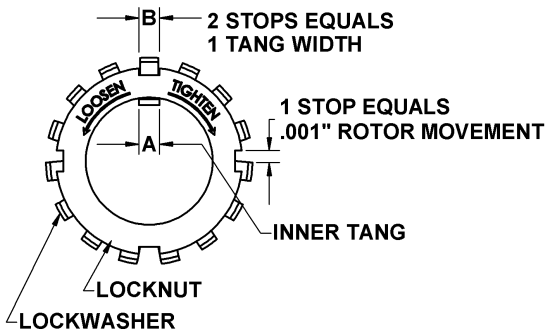
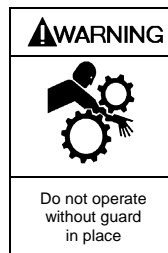

Figure 11 - Locknut Adjustment

- a. On both ends of the pump shaft, Install a lockwasher (24B) with the tangs facing outward, followed by a locknut (24A) with the tapered end inward. Ensure the inner tang "A" of the lockwasher is located in the slot in the shaft threads, bending it slightly, if necessary.
- b. Tighten both locknuts (24A) to ensure that the bearings (24) are bottomed in the head recess. **DO NOT** overtighten and bend or shear the lockwasher inner tang.
- c. Loosen both locknuts one complete turn.
- d. Tighten one locknut until a slight rotor drag is felt when turning the shaft by hand.
- e. Back off the nut the width of one lockwasher tang "B". Secure the nut by bending the closest aligned lockwasher tang into the slot in the locknut. The pump should turn freely when rotated by hand.

- f. Tighten the opposite locknut (24A) by hand until it is snug against the bearing (24). Then, using a spanner wrench, tighten the nut the width of one lockwasher tang. Tighten just past the desired tang, then back off the nut to align the tang with the locknut slot. Secure the nut by bending the aligned lockwasher tang into the slot in the locknut. The pump should continue to turn freely when rotated by hand.
  - g. To check adjustment, grasp the nut and washer with fingers and rotate back and forth. If this cannot be done, one or both locknuts are too tight and should be alternately loosened one stop at a time (.001" – 25 microns). Begin by loosening the locknut adjusted last.
16. Inspect the grease seal (104) for wear or damage and replace as required. Grease the outside diameter of the grease seal and push it into the inboard bearing cover (27) with the lip of the seal inward.
  17. Attach a new bearing cover gasket (26) and the bearing cover (27) to the inboard head (20). Make sure the grease fittings (76) are accessible. Install and torque the bearing cover capscrews (28) to 30 lbs ft (40.7 Nm).
  18. Install the grease seal (104) and bearing cover (27) on the opposite side of the pump as instructed in steps 16 and 17.
  19. On 2-inch pump models, push the dirt shield (123A) over the inboard and outboard shafts and firmly against the bearing cover (27).
  20. Attach the shaft protector (186) to the non-driven shaft end of double ended pumps.



**Operation without guards in place can cause serious personal injury, major property damage, or death.**

21. See "Pre-Start Up Check List" and "Start Up Procedures" sections of this manual prior to restarting pump operation.

## TROUBLESHOOTING

### NOTICE:

**Maintenance shall be performed by qualified technicians only, following the appropriate procedures and warnings as presented in this manual.**

#### SYMPTOM

#### PROBABLE CAUSE

#### Pump Not Priming

1. Pump not wetted.
2. Worn vanes.
3. Internal control valve closed.
4. Strainer clogged.
5. Inlet line or valves clogged or too restrictive.
6. Pump vapor-locked.
7. Pump speed too low for priming.
8. Relief valve partially open, worn or not seating properly.

## TROUBLESHOOTING - continued

<b>SYMPTOM</b>	<b>PROBABLE CAUSE</b>
<b>Reduced Capacity</b>	<ol style="list-style-type: none"><li>1. Pump speed too low.</li><li>2. Internal control valve not fully open.</li><li>3. Excessive restriction in the inlet line (i.e.: undersized piping, too many elbows &amp; fittings, clogged strainer, etc.).</li><li>4. Damaged or worn parts (vanes, cylinder, or rotor).</li><li>5. Excessive restriction in discharge line causing partial flow through the relief valve.</li><li>6. Relief Valve worn, set too low, or not seating properly.</li><li>7. External Bypass Valve set too low.</li><li>8. Operating without a vapor return line.</li><li>9. Vanes installed incorrectly (see "Vane Replacement").</li><li>10. Liner installed backwards.</li></ol>
<b>Noise</b>	<ol style="list-style-type: none"><li>1. Excessive pressure drop on the pump due to:<ol style="list-style-type: none"><li>a. Undersized or restricted fittings in the inlet line.</li><li>b. Pump speed too fast.</li><li>c. Pump too far from fluid source.</li></ol></li><li>2. Running the pump for extended periods with a closed discharge line.</li><li>3. Pump not securely mounted.</li><li>4. Improper drive line – truck mounted pumps (See "Pump Drive").</li><li>5. Misalignment of pump, reducer, or motor - base mounted pumps.</li><li>6. Bearings worn or damaged.</li><li>7. Vibration from improperly anchored piping.</li><li>8. Bent shaft, or drive coupling misaligned.</li><li>9. Excessively worn rotor.</li><li>10. Malfunctioning valve in the system.</li><li>11. Relief valve setting too low.</li><li>12. Liner installed backwards.</li><li>13. Damaged vanes (see following category).</li></ol>
<b>Damaged Vanes</b>	<ol style="list-style-type: none"><li>1. Foreign objects entering the pump.</li><li>2. Running the pump dry for extended periods of time.</li><li>3. Cavitation.</li><li>4. Excessive heat.</li><li>5. Worn or bent push rods, or worn push rod holes.</li><li>6. Hydraulic hammer - pressure spikes.</li><li>7. Vanes installed incorrectly (see "Vane Replacement").</li><li>8. Incompatibility with the liquids pumped.</li></ol>
<b>Broken Shaft</b>	<ol style="list-style-type: none"><li>1. Foreign objects entering the pump.</li><li>2. Relief valve not opening.</li><li>3. Hydraulic hammer - pressure spikes.</li><li>4. Pump/driver, driveline/drive shaft misalignment.</li><li>5. Excessively worn vanes or vane slots.</li></ol>
<b>Mechanical Seal Leakage</b>	<ol style="list-style-type: none"><li>1. O-rings not compatible with the liquids pumped.</li><li>2. O-rings nicked, cut or twisted.</li><li>3. Shaft at seal area damaged, worn or dirty.</li><li>4. Bearings overgreased.</li><li>5. Excessive cavitation.</li><li>6. Mechanical seal faces cracked, scratched, pitted or dirty.</li></ol>
<b>Overload on Motor</b>	<ol style="list-style-type: none"><li>1. Motor Horsepower not sufficient for application.</li><li>2. Improper wiring and/or low voltage to motor.</li><li>3. Misalignment</li><li>4. Excessive pressure or speed.</li><li>5. Bearing locknuts adjusted improperly.</li><li>6. Faulty or worn bearings.</li><li>7. Rotor rubbing against discs or liner.</li><li>8. Dirty mechanical seal faces.</li></ol>



Visit [www.blackmer.com](http://www.blackmer.com) for complete information on all Blackmer products

1809 Century Avenue, Grand Rapids, Michigan 49503-1530 U.S.A.  
Telephone: (616) 241-1611 • Fax: (616) 241-3752  
E-mail: [blackmer@blackmer.com](mailto:blackmer@blackmer.com) • Internet Address: [www.blackmer.com](http://www.blackmer.com)