

# BLACKMER LB-EC COMPRESSORS

960489  
INSTRUCTIONS 502-B00

## Installation, Operation, and Maintenance Instructions

Section	502
Effective	May 2023
Replaces	Jan 2023





MODEL: LB082ECA

### TABLE OF CONTENTS

<b>Safety Data</b> .....	1	<b>Maintenance</b>	
<b>General Information</b>		Service Schedule .....	11
Compressor Data .....	3	Tool List .....	12
Nameplate Data .....	4	Bolt Torque Table .....	12
Maximizing Compressor Life .....	5	Crankcase Lubrication .....	13
<b>Installation</b>		Setting the Oil Pressure .....	13
Location and Piping .....	6	<b>Compressor Disassembly</b> .....	14
Mounting the Compressor Unit .....	6	<b>Compressor Assembly</b> .....	15
Stationary Compressors .....	6	<b>Valve Replacement</b> .....	17
Compressor Flywheel .....	7	<b>Seal (Packing) Replacement</b> .....	18
V-Belt Drive .....	7	<b>Bearing Replacement</b> .....	19
Relief Valves .....	8	<b>Oil Pump Replacement</b> .....	20
Liquid Traps .....	8	<b>Moving and Extended Storage</b> .....	20
Temperature and Pressure Switches .....	8	<b>Troubleshooting</b> .....	21
Pressure Gauges .....	9		
<b>Operation</b>			
Pre Startup Check List .....	9		
Start Up Procedure .....	10		

### IMPORTANT SAFETY INSTRUCTIONS

#### SAVE THESE INSTRUCTIONS

 <p>This is a SAFETY ALERT SYMBOL. When you see this symbol on the product, or in the manual, look for one of the following signal words and be alert to the potential for personal injury or property damage.</p>  <p>Warns of hazards that WILL cause serious personal injury, death or major property damage.</p>  <p>Warns of hazards that CAN cause serious personal injury, death or major property damage.</p>  <p>Warns of hazards that CAN cause personal injury, or property damage.</p> <p><b>NOTICE</b> Indicates special instructions which are very important and must be followed.</p>	<h4>NOTICE</h4> <p>Blackmer compressors <b>MUST</b> only be installed in systems which have been designed by qualified engineering personnel. The system <b>MUST</b> conform to all applicable local and national regulations and safety standards.</p> <p>These instructions are intended to assist in the installation and operation of Blackmer compressors and <b>MUST</b> be kept with the compressor.</p> <p>Blackmer compressor service and maintenance shall be performed by qualified technicians <b>ONLY</b>. Service and maintenance shall conform to all applicable local and national regulations and safety standards.</p> <p>Thoroughly review this manual, all instructions and hazard warnings, <b>BEFORE</b> performing any work on the compressor.</p> <p>Maintain <b>ALL</b> system and compressor operation and hazard warning decals.</p> <p>For handling liquefied gas, NFPA Pamphlet 58 should be consulted.</p> <p>Do not put fingers or hands into the product</p>
---	--

## SAFETY DATA

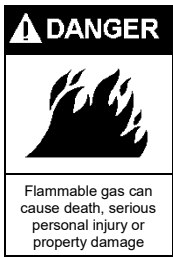

**Flammable gas and/or liquid can form explosive mixtures with air causing property damage, serious personal injury or death**

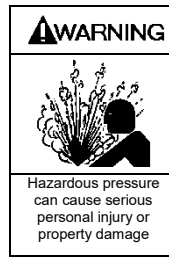

**Failure to relieve system pressure prior to performing compressor service or maintenance can cause serious personal injury or property damage.**

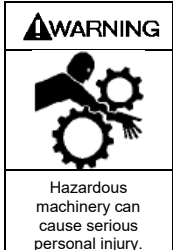

**Failure to disconnect and lockout electrical power or engine drive before attempting maintenance can cause severe personal injury or death**

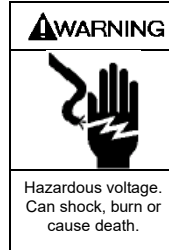

**Failure to disconnect and lockout electrical power before attempting maintenance can cause shock, burns or death**

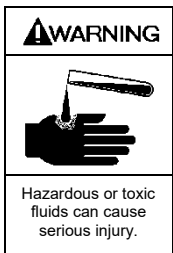

**If handling hazardous or toxic fluids, system must be flushed and decontaminated, inside and out, prior to performing service or maintenance**

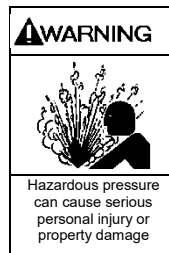

**Disconnecting fluid or pressure containment components during compressor operation can cause serious personal injury, death or major property damage**

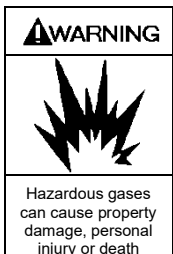

**Explosive gas can cause property damage, personal injury, or death.**

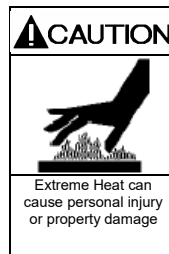

**Extreme heat can cause personal injury or property damage**

**Turn the power switch to the off position before attempting to clear a jam or remove an object from the compressor.**

**When attempting to loosen a jam in the compressor, use a long wooden object such as a wooden spoon or the wooden handle of a broom or mop.**

**When attempting to remove objects from the compressor, use long-handled tongs or pliers.**

## GENERAL INFORMATION

### Compressor Data

The model listed is a single-stage, vertical, air-cooled reciprocating style compressor with a single acting cylinder.

Model	<b>LB082ECA</b>
Minimum / Maximum RPM *	350 / 825 Reduce maximum speeds by 9% for continuous duty operation.
Displacement @ min rpm - CFM (m <sup>3</sup> /hr) @ max rpm - CFM (m <sup>3</sup> /hr)	3.58 (6.1) 8.44 (14.3)
Max. BHP (kw)	7.5 (5.5)
MAWP - psia (kPa)	350 (2,413)
Maximum Discharge Temperature	350°F (176°C)
Rotation Direction	Bi-Directional
Critical Dimensions	See Document CB240

**Table 1 - Compressor Data**

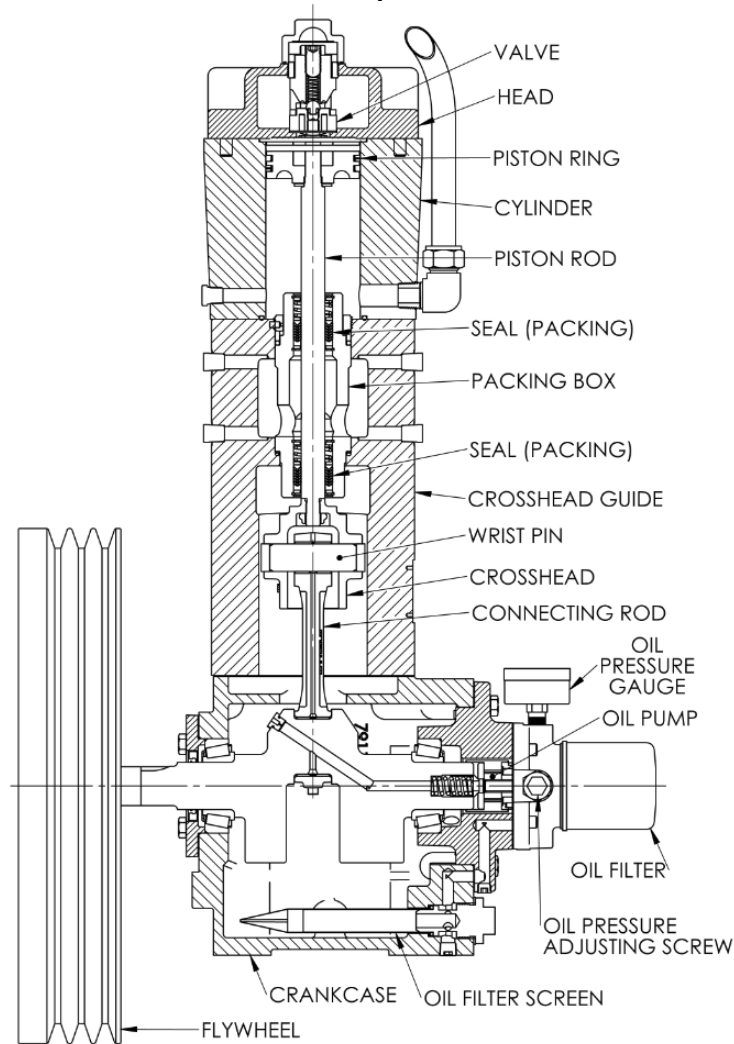

**Figure 1 - Typical Compressor**

## GENERAL INFORMATION

MODEL: LB082ECA ID#: \_\_\_\_\_ SERIAL NO: \_\_\_\_\_

Before proceeding:

1. Note the nameplate data in the space provided above.
2. Obtain the appropriate parts lists for the model in question.

Manuals and Parts Lists for Blackmer products may be obtained from Blackmer's website ([www.blackmer.com](http://www.blackmer.com)) or by contacting Blackmer's Customer Service.

### NAMEPLATE DATA

A nameplate is attached to the side of all Blackmer compressors showing the Model No., I.D. No., and Serial No. These numbers should be available when information or parts are needed for a particular unit.

The basic size and type of the compressor is indicated by "Model No." A suffix letter is used on most models to indicate the version.

For detailed ATEX Declaration information, refer to FORM 576 found in the Certification section of Blackmer's website.

An 11 character "I.D. No." identifies the construction of the compressor.

PART NO.  
791217-005

1809 Century Avenue SW  
Grand Rapids MI 49503

MODEL NO.

ATTENTION! ID NO.

Operate according to instruction manual. SERIAL NO.

**LPG COMPRESSOR** YR/MO CONST.

Leakage Rate: 4.0 mL/min Max

Hazardous Location Rating Class 1, Div. 1, Group D

ASSEMBLED IN U.S.A. Crankcase oil capacity 60 OZ (1.8L)

**Figure 2 - Compressor Nameplate**

VALVES	Code	Fields
Steel, w/ Liquid Relief	BA	1 & 2
<b>O-RINGS</b>		
Buna-N	B	Field 3
<b>GASKETS</b>		
Aluminum	A	Field 4
<b>PISTON RINGS</b>		
Carbon Filled PTFE	C	Field 5
<b>SEAL (PACKING) ORIENTATION</b>		
All Lips up	1	Field 6
<b>SEAL MATERIAL</b>		
PTFE	T	Field 7
<b>CYLINDER &amp; HEAD</b>		
Ductile Iron	A	Field 8
<b>PISTON RODS</b>		
Black Surface Steel	4	Field 9
<b>CRANKSHAFT &amp; OIL FILTER</b>		
Spin-on Oil Filter (std)	C	Field 10
<b>FLYWHEEL *</b>		
Standard Flywheel	0	Field 11
No Flywheel	N	

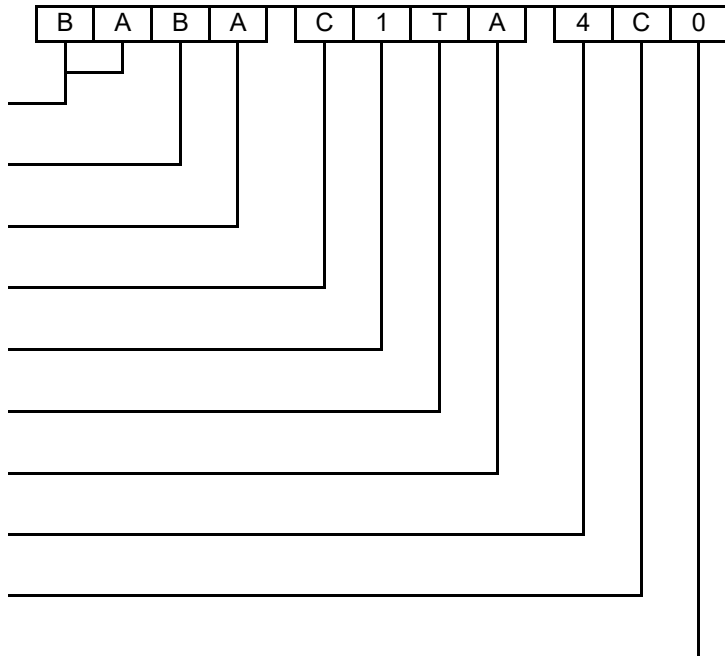

\* Models Configured prior to 11/01/2017 used an "A" in this position to indicate standard selections.  
 Note: A 'Z' in any field indicates a non-standard option. No model is available with all shown options.

**Table 2 - ID Number Key**

## GENERAL INFORMATION

### MAXIMIZING COMPRESSOR LIFE

Life of critical compressor components such as piston rings, valves and packing will vary considerably with each application, installation, and operating procedures. Premature failure of wear parts can often be attributed to one of the following causes:

#### Excessive Temperatures

Primary causes are:

- Operating at pressures other than those originally specified.
- Handling a different gas than originally specified.
- Clogged strainer or filter elements.
- Line sizes too small, or other flow restrictions.
- Excessive ambient temperature or suction gas temperature.
- Valve problems. (See Foreign Material.)
- Badly worn piston rings. (See Foreign Material.)

Lower operating temperatures will increase valve and piston ring life significantly.

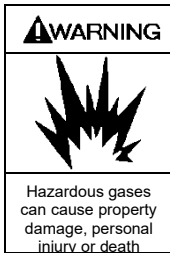

**Extreme temperatures caused by abnormally high discharge pressure or valve problems can be a source of ignition in explosive atmospheres causing severe personal injury or death.**

#### Foreign Material

Solid particles in the gas stream will:

- Rapidly wear the piston rings and score the cylinder wall.
- Destroy the rod packing causing excessive leakage and score the piston rods.
- Lodge in the valves causing loss of capacity and broken valve plates and springs.

Liquid in the gas stream will:

- Cause broken valve plates and springs.
- Destroy the compressor if present in sufficient quantity.

On new installations, it is suggested that the valves and piston rings be inspected after the first few hundred hours of operation. This will give an early indication of any abnormal problems and allow for corrective action to be taken before a costly failure results. Although piston ring life will vary from application to application, wear will be fairly consistent on subsequent sets of rings.

# INSTALLATION

## NOTICE:

Blackmer compressors must only be installed in systems designed by qualified engineering personnel. System design must conform with all applicable regulations and codes and provide warning of all system hazards.

## WARNING:

Risk of explosion – Due to the compressor having a flammable gas leakage rate of 4.0 mL/min, the equipment shall only be installed in a Class I Division 1 location.

## NOTICE:

This compressor shall be installed in accordance with the requirements of NFPA 58 and all applicable local, state and national regulations.

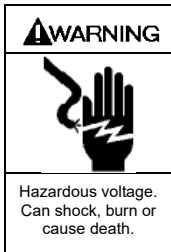

- ⚠ Install, ground and wire to local and National Electrical Code requirements.
- ⚠ Install an all-leg disconnect switch near the unit motor.
- ⚠ Disconnect and lockout electrical power before installation or service

- ⚠ Electrical supply **MUST** match motor nameplate specifications.
- ⚠ Motors equipped with thermal protection automatically disconnect motor electrical circuit when overload exists. Motor can start unexpectedly and without warning.

## LOCATION AND PIPING

Compressor life and performance can be significantly reduced when installed in an improperly designed system. Before starting layout and installation of the piping system, consider the following:

1. All piping must be leak free to a pressure of 1.5 times the maximum system pressure.

**NOTICE: If the system is to be hydro-statically tested, the compressor MUST be isolated. Liquid entering the compressor will cause damage and void the warranty.**

2. A strainer should be installed in the inlet line to protect the compressor from foreign matter. A #30 mesh screen or finer is recommended. Strainers **must** be cleaned every 180 days, or more frequently if the system requires.
3. Expansion joints, placed within 36" (0.9 m) of the compressor, will compensate for expansion and contraction of the pipes. Contact the flexible connector/hose manufacturer for required maintenance/care and design assistance in their use.
4. Piping **must** be adequately supported to ensure that no piping loads are placed upon the compressor.

5. Both suction and discharge piping should slope down from the compressor. The compressor should not be placed at a low point in the piping system.



Discharge piping surface temperatures may be hot during operation (over 158°F, 70°C). Temperatures should be monitored and adequate warnings posted.

## MOUNTING THE COMPRESSOR UNIT

### Stationary Compressors

A solid foundation reduces noise and vibration, and will improve compressor performance. On permanent installations, it is recommended the compressor be secured by anchor bolts as shown. This arrangement allows for slight shifting of position to accommodate alignment with the mounting holes in the base plate.

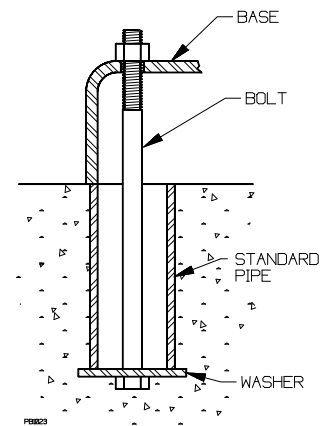

Figure 3 - Anchor Bolt

Set the anchor bolts in concrete for new foundations. When compressors are to be located on existing concrete floors, holes should be drilled into the concrete to hold the anchor bolts.

To keep vibration at a minimum, in addition to a solid concrete foundation, it is important that the concrete be located on a stable soil foundation. The base must have complete contact along its entire length with the foundation. Visible separations will result in vibrations which are magnified in the upper part of the unit.

See CB220 "Compressor Bases, Skids and Foundations" for additional information.

# INSTALLATION

## COMPRESSOR FLYWHEEL

Blackmer compressors are fitted with flywheels which **MUST** be used regardless of the type of drive system employed.

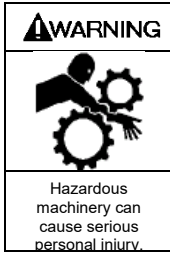

**Failure to disconnect and lockout electrical power or engine drive before attempting maintenance can cause severe personal injury or death**

Flywheels must be properly installed and aligned:

1. Ensure that the mating surface between the hub and flywheel are clean and dry – do not use a lubricant.
2. Install the hub and key on clean compressor shaft, flange end first.
3. Tighten the hub setscrew just enough to prevent it from sliding on the shaft – do not overtighten.
4. Place the flywheel on the hub and loosely thread the capscrews with lockwashers into the assembly. Do not use lubricant on the capscrews.
5. Tighten all capscrews evenly and progressively in rotation to the torque value in Table 3. There must be a gap between the hub flange and the flywheel with installation is complete. **Do not over-torque. Do not attempt to close gap between hub flange and flywheel.**

Hub Size	Capscrew Size	Torque ft-lbs. (Nm)
SF	3/8 – 16	30 (40.7)

**Table 3 – Flywheel Hub Torque Values**

6. Ensure that the radial and axial runout values at the rim do not exceed the following values:  
Radial O.D. Runout: 0.016 in. (0.4046 mm)  
Axial Rim Runout: 0.021 in. (0.5334 mm)
7. Ensure that the compressor flywheel guard is properly installed before operation. The guard must not contact moving parts.

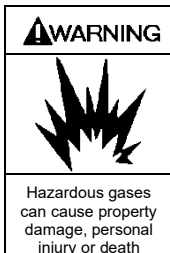

**Flywheel guard contact with moving parts may be a source of ignition in explosive atmospheres causing severe personal injury or death**

## V-BELT DRIVES

Most Blackmer compressors are driven via V-belts which must be properly aligned and tensioned.

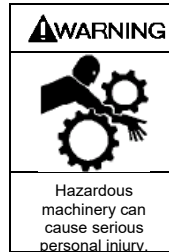

**Failure to disconnect and lockout electrical power or engine drive before attempting maintenance can cause severe personal injury or death**

1. Lay a straight edge along the face of the motor sheave and compressor flywheel.
2. Adjust either as needed to provide alignment.
3. Tighten the V-belts such that they are taut, but not overly tight. Moderate thumb pressure should deflect each belt about 1/4 – 3/8 in. (6 – 10 mm). Consult your V-belt supplier for specific values.
4. Check the belt tension after 24 - 48 hours run-in. Recheck the tension periodically, and tighten the belts as required.

Caution should be used to avoid overtightening belts, which can shorten bearing and belt life. Belts should be inspected periodically for signs of excessive wear and replaced if necessary.

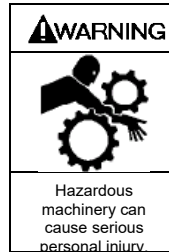

**Operation without guards in place can cause serious personal injury, major property damage or death.**

## INSTALLATION

### RELIEF VALVES

A relief valve of a type, material and pressure rating suitable to the installation, **MUST** be installed. The relief valve shall be installed in the discharge line between the compressor head and the first block valve.



**Compressor operating against closed valve can cause system component failure, personal injury or property damage.**

Since all systems differ in design, care must be taken to ensure the relief valve is installed to safely vent away from sources of ignition and personnel. This can be accomplished by either orientation or a pipe away; consult the Relief Valve manufacture for assistance.

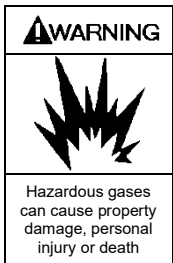

**Operation of the relief valve can release explosive gas to the atmosphere creating an explosion hazard, possibly causing personal injury or death**

Should the Relief Valve actuate, the cause **MUST** be determined and corrected before continuing operations. See the 'Troubleshooting' section.

Blackmer offers various relief valves for gas and application compatibility:

- Brass for LP-Gas service
- Aluminum for anhydrous ammonia
- Steel, A.S.M.E. code stamped for both services, and other applications.

### LIQUID TRAPS

Compressors handling gasses containing condensates or other liquids **MUST** be protected from entry of the liquid. Liquid can also enter the compressor from the discharge piping, particularly if the piping slopes down toward the compressor. To prevent liquid from entering the compressor and causing major damage, it is necessary to carefully consider the system design and have strict procedures for operation.

**NOTICE: Liquid in the compressor cylinder can cause destruction of the compressor.**

Blackmer offers a variety of liquid traps. The most common variations include:

1. A non-code vessel fitted with a stainless steel float which will shut off the intake line to the compressor in the event of an excessive liquid level. A vacuum breaking valve is provided on the liquid trap head in case the trap closes and a vacuum develops between the compressor and the trap. A manual drain valve is provided.

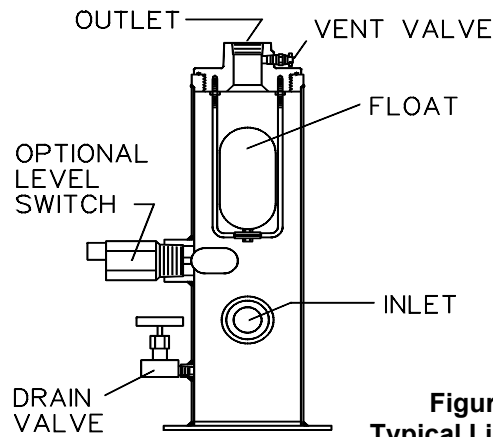

**Figure 4 – Typical Liquid Trap**

2. The above trap is fitted with a port allowing the use of an electric float switch which protects the compressor by stopping the compressor when a high liquid level is present in the liquid trap. The electric float switch may be used with or without the mechanical float described above.
3. For additional protection, a larger ASME code stamped vessel is available. This liquid trap is typically fitted with one or two electric float switches for both a high liquid level shut down and alarm signal, a relief valve, and a manual drain valve. This type trap is needed if level gauges or automatic drain systems are to be used.

### TEMPERATURE SWITCHES

Excessive discharge temperature is a leading cause of premature component failure and is often an early warning sign of impending problems.

Optional temperature switches should be installed with a thermowell as close to the compressor discharge as possible. The switch should be set to actuate at a temperature just above the maximum operating temperature of the compressor.

ATEX compliant compressors **must** have a temperature switch installed.

### LOW OIL PRESSURE SWITCHES

Loss of crankcase oil pressure is a rare occurrence, but can result in costly damage. An optional low oil pressure switch set at about 15 psig (1 bar-g) may be installed to shut down the compressor in the event of a lubrication failure. A 10 second delay timer should be used to lock the low oil pressure switch out during compressor startup.



# INSTALLATION

## PRESSURE SWITCHES

Pressure switches may be installed in the suction or discharge gas stream as protective devices, for compressor control, or for other uses varying with each application and system design.

## PRESSURE GAUGES

Install pressure gauges in the discharge and inlet lines to verify actual suction and discharge pressures.

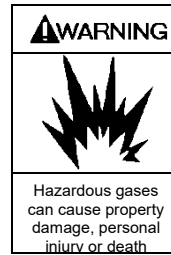

**Optional liquid trap level switches, temperature switches, pressure switches or other electrical devices must be properly specified for applications using explosive gases.**

# OPERATION

## PRE-STARTUP CHECK LIST

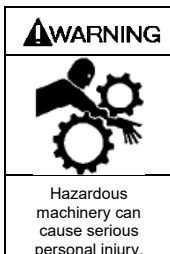

**Failure to disconnect and lockout electrical power or engine drive before attempting maintenance can cause severe personal injury or death**

1. After the compressor is installed in the system, a complete leak test **MUST** be performed on both the compressor and the piping.

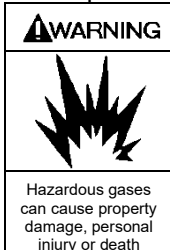

**Failure to properly leak test the compressor installation may result in leakage of explosive gas to the atmosphere creating an explosion hazard, possibly causing severe personal injury or death.**

2. Re-check the system piping and the piping supports to ensure that no piping loads are being placed on the compressor.



**Discharge piping surface temperatures may be hot during operation (over 158°F, 70°C). Temperatures should be monitored and adequate warnings posted.**

3. If V-belt driven, check the alignment of the motor and the compressor sheaves. The faces of the sheaves must be parallel.
4. Ensure that pressure gauges are installed on both inlet and discharge of the compressor.

5. Blackmer compressors are shipped from the factory without oil in the crankcase. Fill with a high quality non-detergent oil of the proper viscosity via the compressor nameplate opening. See "Crankcase Lubrication" in this manual.
6. Check the electrical connections for proper wiring, grounding, etc.
7. With the power disconnected, remove the compressor nameplate. Squirt oil onto each crosshead while rotating the compressor by hand to verify smooth operation.
8. Ensure that all guarding is properly installed.

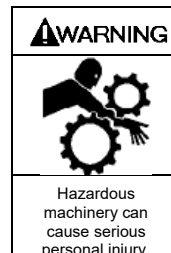

**Operation without guards in place can cause serious personal injury, major property damage or death.**



**Flywheel guard contact with moving parts may be a source of ignition in explosive atmospheres causing severe personal injury or death**

# OPERATION

## STARTUP PROCEDURE

### NOTICE:

Consult the 'Troubleshooting' section of this manual if difficulties during startup are experienced.

1. Start the compressor. Oil pressure should register 25 psig (172 kPa) within 10 seconds.

**If proper oil pressure is not present, stop the compressor and correct the problem.**

Operating the compressor with low oil pressure will cause severe damage to the unit. Adjust if necessary. See "Setting the Oil Pressure".

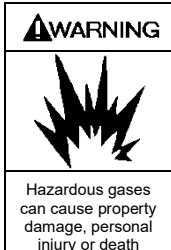

**Operation of the compressor with low or no oil may result in extreme temperature in the crankcase. This could be an ignition source in the presence of explosive gas and could lead to severe personal injury or death.**

The oil pump on these models will operate in either direction of crankshaft rotation.

2. Verify that the suction and discharge pressures are within the expected ranges.

**Operating limits listed in the "Compressor Data" section must not be exceeded.**

3. Check for leakage from the piping and equipment, and repair as necessary.
4. If the seals (packing) have just been replaced or if the compressor has been out of service for over 6 months, the lower seal **MUST** be manually lubricated during the first 60 minutes of operation. See "Seal (Packing) Replacement" section. New compressors have had the packing broken in at the factory.
5. On newly rebuilt units, the valve hold down screws, valve cover plate bolts and cylinder head bolts **MUST** have their torque checked after 60 minutes running time. Also re-tighten all hold down bolts, flywheel bolts, etc. after 60 minutes running time. See Table 6 - "Bolt Torque."

## MAINTENANCE

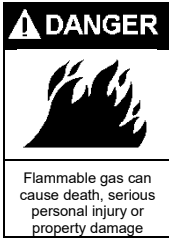

**Flammable gas and/or liquid can form explosive mixtures with air causing property damage, serious personal injury or death**

Flammable gas can cause death, serious personal injury or property damage

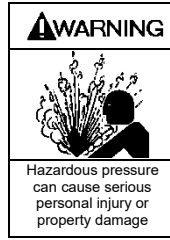

**Failure to relieve system pressure prior to performing compressor service or maintenance can cause serious personal injury or property damage.**

Hazardous pressure can cause serious personal injury or property damage

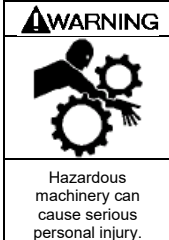

**Failure to disconnect and lockout electrical power or engine drive before attempting maintenance can cause severe personal injury or death**

Hazardous machinery can cause serious personal injury.

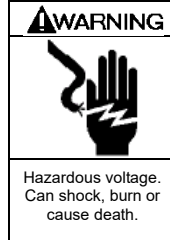

**Failure to disconnect and lockout electrical power before attempting maintenance can cause shock, burns or death**

Hazardous voltage. Can shock, burn or cause death.



**If handling hazardous or toxic fluids, system must be flushed and decontaminated, inside and out, prior to performing service or maintenance**

Hazardous or toxic fluids can cause serious injury.

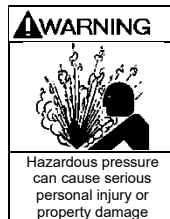

**Disconnecting fluid or pressure containment components during compressor operation can cause serious personal injury, death or major property damage**

Hazardous pressure can cause serious personal injury or property damage

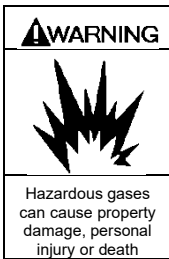

**Explosive gas can cause property damage, personal injury, or death.**

Hazardous gases can cause property damage, personal injury or death



**Extreme heat can cause personal injury or property damage**

Extreme Heat can cause personal injury or property damage

### NOTICE:

**Blackmer compressor service and maintenance shall be performed by qualified technicians only. Service and maintenance shall conform to all applicable local and national regulations and safety standards.**

### SERVICE SCHEDULE

	Daily	Weekly	Monthly	6 Months	Yearly
Overall Visual Check	X				
Check Crankcase Oil Pressure	X				
Check Suction and Discharge Pressures	X				
Drain Liquid From Accumulation Points		X			
Clean Compressor Cooling Fins		X			
Check Crankcase Oil Level *			X*		
Check Mounting and Anchor Bolts			X		
Check V-Belt Tension			X		
Change Oil and External Oil Filter *				X*	
Check Inlet Filter/Strainer Element				X	
Inspect Valves				X	
Lubricate 4-way Valve (if equipped)				X	
Lubricate Motor Bearings per Manufacturer's Suggestions				X	
Inspect Motor Starter Contact Points					X

\* Change oil every 1,000 hours of operation, or every 6 months whichever occurs first. If the oil becomes dirty or diluted, change oil and external filter as often as needed to maintain clean oil.

**Table 4 - Service Schedule**

## MAINTENANCE

### TOOL LIST

Description	Used For:
Blackmer Wrench 798016	Valve Hold-down Ring Torque Tool
Blackmer Packing Installation Tool 790536 for 080 Series Compressors	Rod-packing protection during installation.
Blackmer Torque Wrench Adaptors 798003 for LB082	Piston
3" Adjustable Spanner with 1/4" pins Blackmer PN 790316	Piston Nut, Piston, Packing Box Hold-down Ring
9/16", 5/8" or 3/4" End Wrench	Cylinder and Crosshead Guide
1-1/16" Wrench or Socket	Valve Caps
Allen Wrenches: 3/16", 1/4", 3/8"	Valves
Sockets: 7/16", 1/2", 9/16", 5/8", 3/4", 7/8"	Various
Internal Snap Ring Pliers	Seal Replacement
Feeler gauges or Depth Micrometer	Piston Clearance
Screwdriver, Flat Blade	Nameplate screws, Packing Installation
Pliers	
Rubber Mallet	
Arbor Press	Wrist Pin Removal
Bearing Puller	Crankshaft Bearings
Torque Wrench	Various
Hoist (useful)	Cylinder and Crosshead Guide

**Table 5 - TOOL LIST**

### BOLT TORQUES FOR BLACKMER COMPRESSORS LBS-FT (Nm)

Size	Con. Rod Bolt	Bearing Carrier	Bearing Cover Plate	Crank-case Inspec. Plate	Oil Pump Cover	Cross Head Guide	Cylinder	Head	Piston & Nut	Valve Cover Plate	Valve Hold Down Screw	Valve Cap	Packing Box Hold Down Ring
081 082	30 (40.7)	30 (40.7)	35 (47.5)	7 (9.5)	12 (16.3)	25 (33.9)	25 (33.9)	20 (27.1)	40 (54)	--	120 (163)	80 (108)	75 (102)

**Table 6 - Bolt Torque**

# MAINTENANCE

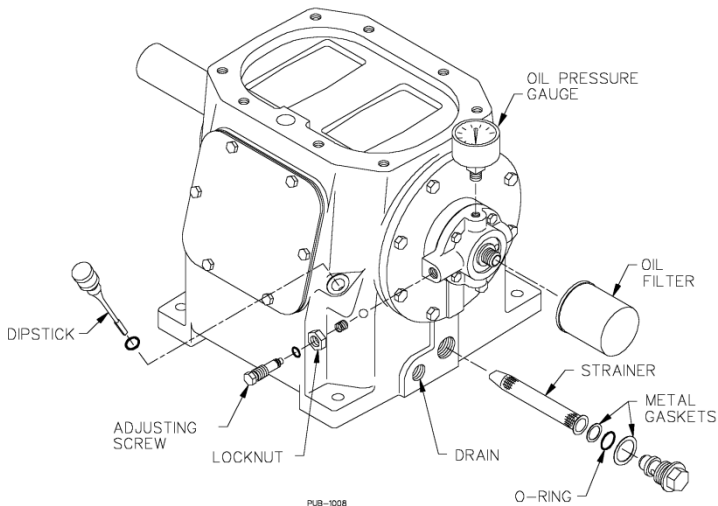

**Figure 6 - Compressor Lubrication System**

## CRANKCASE LUBRICATION

Change the crankcase oil every 1,000 hours or 180 days, whichever is shorter. Under severe dusty, sandy or wet operating conditions, the oil should be changed every 500 hours or every 90 days.

If the crankcase oil becomes contaminated or diluted due to gas leakage past the packing seals, the oil must be changed more frequently. In such cases, change the packing seals as soon as possible.

Non-detergent oils are recommended. Detergent oils can be used providing the gas being handled does not react with the detergent in the oil. If using a detergent oil, be sure there is not a compatibility problem. Ammonia, amine and imine gases are known to react with many of the detergents in oil.

**The oil used, detergent or non-detergent, should be of high quality such as API grade SJ, SL, SM, SN or similar.**

**API grade SA, SB, SC or similar oils should never be used. Recycled oils should never be used.**

Synthetic oils are acceptable; use the same guidelines as mineral based lubricants. Consult factory for special lubricating requirements.

Before changing the oil, bring the compressor up to normal operating temperature. Remove the crankcase drain plug and drain the oil into an adequately sized container. Remove the oil pickup screen and clean in a suitable solvent. When reinstalling the pickup screen, inspect the metal gasket and the O-ring for damage, replacing as necessary. If equipped, replace the external oil filter. See Figure 6.

Refill the crankcase via the dipstick or nameplate opening. **DO NOT OVERFILL THE CRANKCASE!**

The oil pump on these models will operate in either direction of crankshaft rotation.

Model	Quarts	Liters
LB082ECA	1.9	1.8

**Table 7 - Oil Capacity**

### Mineral Based Oil - API Grade SN, SM, SL, SJ

ISO Grade	SAE	Ambient Temperature	Product
100	30	80°F (27°C) and above	Mobil® Rarus 427 or equivalent
46	20	32 to 80°F (0 to 27°C)	
32	10	0 to 32°F (-18 to 0°C)	
22 - 15	5 - 0	Below 0°F (-18°C)	

### Synthetic Oil

ISO Grade	SAE	Ambient Temperature	Product
68	20+	Full Range	Mobil® SHC Rarus 68 or equivalent

**Table 8 - Oil Viscosity**

## SETTING THE OIL PRESSURE (see Figure 5)

1. The oil pressure should be about 25 psig (1.73 Barg).
2. Loosen the locknut.
3. Increase the pressure setting by turning the adjusting screw inward, CLOCKWISE.  
Decrease the pressure setting by turning the adjusting screw outward, COUNTER-CLOCKWISE.
4. Retighten the locknut.

## COMPRESSOR DISASSEMBLY

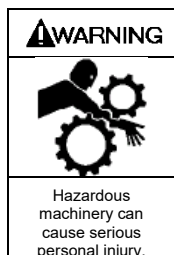

**Failure to disconnect and lockout electrical power or engine drive before attempting maintenance can cause severe personal injury or death**

Hazardous machinery can cause serious personal injury.

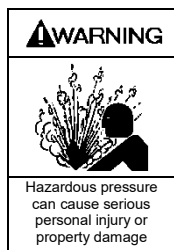

**Failure to relieve system pressure prior to performing compressor service or maintenance can cause serious personal injury or property damage.**

Hazardous pressure can cause serious personal injury or property damage.

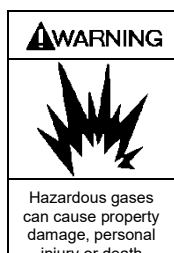

**Venting pressure from the compressor piping could release explosive gas to the atmosphere creating an explosion hazard, possibly causing severe personal injury or death.**

Hazardous gases can cause property damage, personal injury or death.

### NOTICE:

**Before starting work on the compressor, make sure all pressure is bled off on both the suction and discharge.**

1. Remove the cylinder head capscrews.
2. Remove the cylinder head assembly and cylinder head O-rings from the cylinder. The suction and discharge valve assemblies will come off with the cylinder head. For valve replacement instructions, refer to the "Valve Replacement" section of this manual.
3. Removal of the piston requires a 3" adjustable spanner wrench with 1/4" pins. (see 'Tool List' table).
  - a. Rotate the flywheel by hand to bring the piston to top dead center of the cylinder.
  - b. Remove the piston nut by turning the nut counterclockwise. (The nylon locking insert in the piston nut must be replaced during reassembly.)
  - c. To remove the piston from the cylinder, turn it counterclockwise with the use of the adjustable spanner wrench. For removal and replacement of the piston rings, refer to the "Compressor Assembly" section.
  - d. Remove the thrust washer and any shims. Keep the shims and piston together.
4. Remove the cylinder capscrews.
5. Lift the cylinder and cylinder O-rings from the crosshead guide (or distance piece).

6. Packing Box Removal
  - a. Using an adjustable spanner wrench, remove the packing box hold-down rings. (Replace the nylon locking inserts in the hold-down rings during reassembly.)
  - b. Remove the packing box and packing box O-ring from the piston rod.
  - c. For disassembly of the packing box, refer to the "Seal (Packing) Replacement" section of this manual.
7. Remove the crosshead guide capscrews, and lift the crosshead guide and gasket off.
8. To remove the connecting rod assembly, with the crosshead attached, it may be necessary to drain the oil from the crankcase. The piston rod is permanently attached to the crosshead to form a single assembly. Do not attempt disassembly.
  - a. Remove the inspection plate from the crankcase.
  - b. Remove the locknuts from the connecting rod bolts. This will release the connecting rod cap (the lower half of the connecting rod) and the two halves of the bearing insert. The connecting rod and the connecting rod cap are marked with a dot on one side so that they can be properly aligned when reassembling.
  - c. Lift the crosshead assembly and connecting rod off the top of the crankcase.
9. Rest the crosshead assembly on a bench. Carefully drive the wrist pin and wrist pin plugs out of the crosshead and connecting rod using a suitable pin driver or an arbor press. Removal of the pin releases the crosshead assembly from the connecting rod.
10. If necessary, the wrist pin bushing can be replaced after the crosshead is removed. New bushings **MUST** be honed to the proper size after installation. See Table 9 - Wrist Pin Bushing Dimensions.

Compressor Model	Bushing I.D. Inches (mm)
LB082ECA	0.8753 to 0.8756 (22.233 to 22.240)

**Table 9 - Wrist Pin Bushing Dimensions**

11. To replace the crankshaft bearings, the crankcase must be disassembled, and the crankshaft removed. Refer to the "Bearing Replacement" section of this manual.

## COMPRESSOR ASSEMBLY

Compressor assembly is generally the opposite of compressor disassembly. Before reassembling, clean each part thoroughly. Check all machined surfaces for burrs or roughness, and file lightly if necessary. **Replace any O-rings or gaskets that are removed or disturbed during service.**

### 1. CRANKCASE ASSEMBLY

After replacing the crankshaft, bearing carrier, and bearing cover plate, the connecting rod and crosshead can be assembled in the crankcase. See the "Bearing Replacement" section.

- a. To attach the connecting rod to the crosshead assembly, first coat the wrist pin, the wrist pin bore in the crosshead assembly, and the wrist pin bushing in the connecting rod with grease.
- b. Start the wrist pin in the bore of the crosshead assembly until the pin begins to project through to the inside of the crosshead assembly. (Use an arbor press if available.)
- c. Slide the connecting rod up inside of the crosshead assembly and align the bushing with the wrist pin.
- d. Install the wrist pin through the connecting rod until it is centered in the crosshead assembly. The wrist pin should be snug in the crosshead assembly. The connecting rod should rotate freely on the wrist pin, but should not be loose.
- e. Dip the wrist pin plugs in grease and press them against the ends of the wrist pin.
- f. Place the bearing halves into each half of the connecting rod, aligning the bearing tangs with the slots in the connecting rod. Coat the bearing with grease.
- g. Set the top of the connecting rod over the crankshaft journal. Replace the connecting rod cap with the dots on the connecting rod and cap on the same side.
- h. Start the nuts on the connecting rod bolts and torque per Table 6 - "Bolt Torque."

### 2. CROSSHEAD GUIDE

- a. Place the crosshead guide gasket on top of the crankcase.
- b. Lubricate the inside bore of the crosshead guide with light oil.
- c. Set the crosshead guide over the piston rod and crosshead, and slowly lower it against the crankcase. Make certain that the crosshead assembly is started straight in the bore of the crosshead guide to prevent binding when lowering the crosshead guide into position.
- d. Install the crosshead guide capscrews. **DO NOT** tighten.

3. Fill the crankcase with oil. Refer to the "Crankcase Lubrication" section. Squirt oil into the crankshaft, roller bearings, crankshaft journals, and crosshead assemblies to ensure proper lubrication at start up.
4. Attach the inspection plate and the inspection plate gasket to the crankcase.

### 5. PACKING BOX ASSEMBLIES

Before installing the packing boxes into the crosshead guide, inspect the piston rods for scoring or roughness. Remove any burrs or sharp edges. Lubricate the piston rods and packing box O-rings with light oil. **Do not damage the packing when starting it over the rod. Use of a Blackmer packing installation tool is recommended.** (see 'Tool List' table).

#### Single-Seal Models

- a. Insert the packing box O-ring into the crosshead guide.
  - b. Start the packing box assembly, short end down, over the piston rod and into the counter-bored hole of the crosshead guide.
  - c. Install the packing box retainer ring, with new nylon locking inserts, and tighten securely.
6. Rotate the crankshaft by hand a few times, then uniformly tighten the crosshead guide capscrews per Table 6 - "Bolt Torque."
  7. Break in new packing per the "Seal (Packing) Replacement" section of this manual.
  8. **CYLINDER ASSEMBLY**
    - a. Install new O-rings in the bottom of the cylinder. A small amount of grease may be used to hold the O-rings in place during assembly.
    - b. Set the cylinder over the piston rods and against the crosshead guide.
    - c. Install the cylinder capscrews. **DO NOT** tighten.

### 9. PISTON RINGS

- a. Place an expander in the top groove of the piston. Place an expander in the second groove with the break in this expander 180 degrees from the break of the top expander. Place the third expander in the bottom groove with its break in the same position as the top expander.
- b. Place piston rings in all three grooves of the piston. Align the breaks in the piston rings directly opposite the breaks in the corresponding expanders.

## COMPRESSOR ASSEMBLY

### 10. PISTONS

- a. Rotate the flywheel by hand to bring one piston rod to top dead center of the cylinder assembly.
- b. Set the thrust washer and one shim on the shoulder of the piston rod.
- c. With light pressure, squeeze the piston rings inward while threading the piston clockwise onto the rod. Tighten with the 3" adjustable spanner wrench.
- d. Rotate the crankshaft by hand a number of times to verify that the pistons are centered in the cylinder bores. Adjust the cylinder so that the pistons DO NOT touch the cylinder walls.
- e. Using an alternating pattern, torque the cylinder capscrews per Table 6 - "Bolt Torque."

### 11. PISTON CLEARANCE

- a. Rotate the flywheel by hand to bring one piston to the top.
- b. Measure the distance from the top of the piston to the top of the cylinder.

LB082ECA	.015" to .030" (.381 to .762 mm)
----------	-------------------------------------

**Table 10 - Piston Clearance**

- c. If necessary, remove the piston and add or subtract shims accordingly.
- d. Install new nylon locking inserts in the piston retainer nuts.
- e. Thread the piston nut onto the piston rod and tighten securely with the spanner wrench.

### 12. CYLINDER HEAD ASSEMBLY

If the valve assemblies have been removed from the cylinder head, refer to the "Valve Replacement" section of this manual.

- a. Place the cylinder head O-rings in the grooves located on top of the cylinder.
  - b. Place the cylinder head assembly on top of the cylinder.
  - c. Hand tighten the outer capscrews and center capscrews into the cylinder head.
  - d. Uniformly torque the cylinder head capscrews per Table 6 - "Bolt Torque."
13. Rotate the compressor by hand to verify that it turns freely. Ensure that the pistons are not hitting the cylinder head assembly.
  14. Follow all procedures listed in the "Pre-Startup Check List" and "Startup Procedure" sections of this manual.
  15. Start the compressor and bring to normal operating temperature. Stop the compressor, allow it to cool and retorque the valve hold down screws per Table 6 - "Bolt Torque."



## VALVE REPLACEMENT

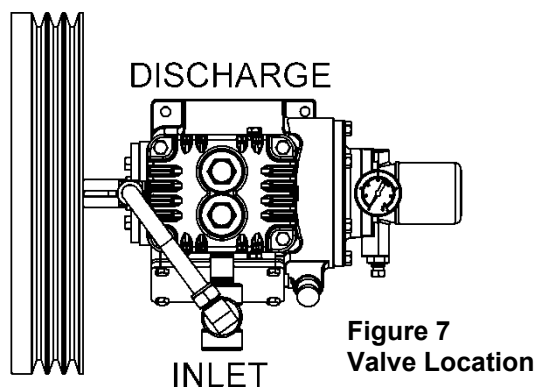

**Figure 7**  
**Valve Location**

Suction and discharge valves **MUST** be installed in the correct cylinder head locations. See Figure 7.

The valves may be removed without removing the cylinder head from the cylinder. Be sure to remove and replace the valve gaskets.

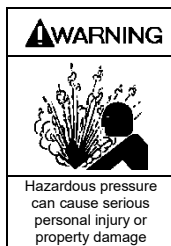

**Failure to install compressor valves properly can lead to component failure, personal injury or property damage.**

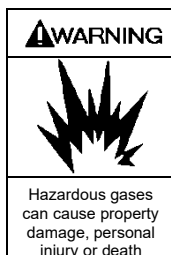

**Failure to install compressor valves properly can result in leakage of explosive gas creating an explosion hazard, possibly causing severe personal injury or death.**

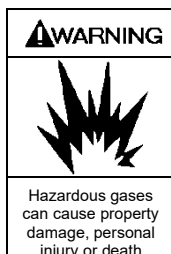

**Failure to install compressor valves properly can result in extreme discharge temperatures. This could be an ignition source in the presence of explosive gas possibly causing severe personal injury or death.**

**MODEL LB082ECA** - see Fig. 8.

1. Remove the valve cap and O-ring from the valve being serviced.
2. Remove the valve hold down screw with a spanner wrench. (see 'Tool List' table).
3. Suction valve - Remove the liquid relief valve body, valve assembly and gasket. **DO NOT** drop the liquid relief ball and spring into the head interior.
4. Discharge valve - Remove the discharge valve cage, valve assembly and gasket.
5. Inspect the valve for wear or breakage.
6. Ensure that the old gasket is removed, then install a new valve gasket.

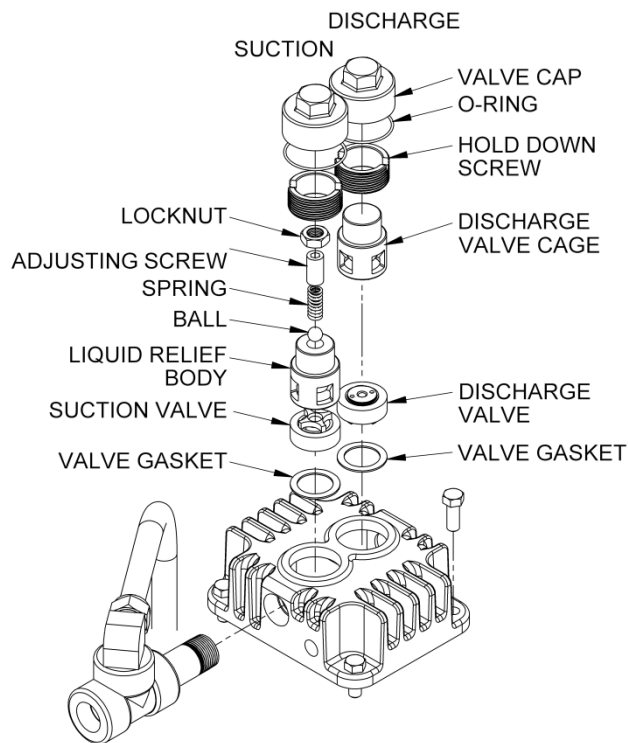

**Figure 8 – Valves**

7. To reinstall the suction valves:
  - a. Install the valve assembly in the cylinder head. Ensure the correct orientation and location of the valve.
  - b. Center the liquid relief body on the valve assembly.
  - c. Install the hold down screw and tighten per Table 6 - "Bolt Torque."
  - d. Drop the liquid relief ball and the liquid relief spring into the opening of the liquid relief body.
  - e. Insert the liquid relief adjusting screw and adjust clockwise until the top of the screw is approximately 3/8" (9.5 mm) above the top of the liquid relief body. Add the locknut and tighten securely.
8. To reinstall the discharge valves:
  - a. Install the valve assembly in the cylinder head. Verify the correct valve orientation and location.
  - b. Center the valve cage on the valve assembly.
  - c. Install the hold down screw and tighten per Table 6 - "Bolt Torque."
9. Install the valve cap and O-ring. A little oil or grease on the O-ring will help hold it in place during installation.
10. After replacing the valves, rotate the flywheel by hand to check for interference between the pistons and the valves.
11. After 60 minutes running time, remove the valve cap and retorque the hold down screw. Replace the valve cap and O-ring.

## SEAL (PACKING) REPLACEMENT

Follow steps 1 through 6 of the "Compressor Disassembly" section of this manual.

1. Remove the upper and lower retainer ring from the packing box being serviced. Disassemble the packing box and discard the old packing sets and packing springs.

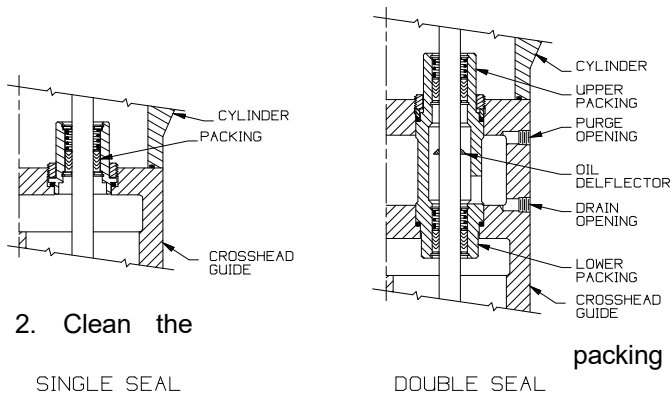

Figure 9 - Typical Seal Assembly

box in a suitable solvent. Inspect the bore for wear, roughness, or corrosion. Clean or replace as necessary.

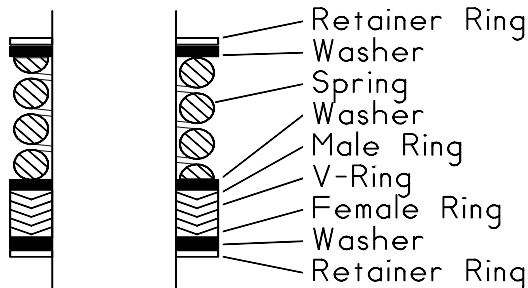

Figure 10 - TYPE 1 Seal Orientation

3. Ensure that the 6<sup>th</sup> digit of the Compressor ID number is a "1", indicating a TYPE 1 packing arrangement. See "Nameplate Data" in this manual. Refer to Figures 9 and 10 for proper TYPE 1 component location and orientation.
4. **Single-Seal Packing Box Assembly**
  - a. Install the lower retainer ring.
  - b. Install the packing rings, spring, washers, and the upper retainer ring. To ease installation on the second retainer ring, use a screwdriver handle and press on the last washer to compress the seal spring slightly.
5. **Two-Seal Packing Box Assembly**
  - a. Install the inner retainer ring of the lower packing.
  - b. Install the packing rings, spring, washers, and the second retainer ring. To ease installation on the second retainer ring, use a screwdriver handle and press on the last washer to compress the seal spring slightly.

- c. Insert the oil deflector ring through the top of the packing box, flat side down, into the cavity between the upper and lower packing. The oil deflector ring will be positioned between the two sets of packing.
- d. Install the upper packing set starting with the inner retainer ring.

### 6. Packing Break-in

The lower packing **MUST** be manually lubricated with oil several times during the first 60 minutes of compressor operation to prevent overheating of the piston rods and potential damage to the packing material. If possible, perform the packing break-in at a lower speed – 400-500 rpm.

To lubricate the packing:

- a. Remove the inspection plate from the crosshead guide.
- b. Run the compressor for 5 minutes then **stop** the compressor for 5 minutes to allow adequate cooling of the piston rods.
- c. Using a small oil can, lubricate the piston rod with 3-4 drops of oil each time the compressor is **stopped**. **DO NOT FLOOD THE ROD WITH EXCESS LUBRICANT.**



**Do not insert objects or fingers in inspection cavity. Can cause severe personal injury**

Hazardous machinery can cause serious personal injury.

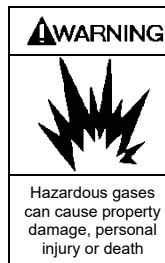

**Improper seal installation could release explosive gas to the atmosphere creating an explosion hazard, possibly causing severe personal injury or death.**

Hazardous gases can cause property damage, personal injury or death

7. Proceed according to steps 5 through 15 of the "Compressor Assembly" section.

## BEARING REPLACEMENT

**NOTICE: When replacing the bearings, the entire bearing assembly, including the bearing cup and the bearing cone, must be replaced and the crankshaft endplay must be readjusted.**

1. Follow steps 1 through 12 of the "Compressor Disassembly" section.
2. Remove the Oil Pump per the section titled "Oil Pump Replacement."
3. Remove the flywheel.
4. Remove the bearing carrier and gasket from the outboard end of the crankcase. The outboard bearing cup will come off with the bearing carrier and will need to be removed with a bearing removal tool.
5. Remove the key from the crankshaft and slide the crankshaft through the outboard end of the crankcase. The bearing cones can then be removed with a bearing puller.
6. Remove the bearing cover plate from the inboard end of the crankcase. The inboard bearing cup is pressed into the crankcase and can be removed with the use of a bearing removal tool.
7. To install the bearings:

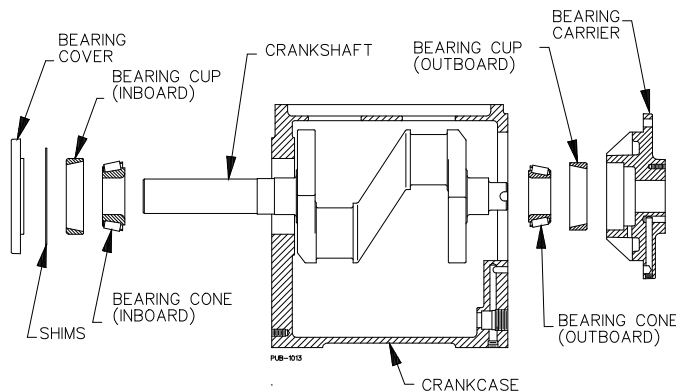

**Figure 11 - Bearing Locations**

- a. Grease the outer edges of the bearing cups.
- b. Referring to Figure 11 for the proper orientation, carefully press the inboard bearing cup into the crankcase until it is flush with the outer surface of the crankcase.

- c. Note the proper orientation and carefully press the outboard bearing cup into the bearing carrier assembly.
  - d. Press a bearing cone onto each end of the crankshaft with the tapered end outward. The bearing race should rest against the shoulder on the crankshaft.
  - e. Lubricate the bearings with grease.
8. Install the crankshaft through the outboard end of the crankcase.
  9. With the oil pump assembly **removed**, install the bearing carrier and new gasket. The bolt hole positions ensure proper orientation. Tighten the bolts evenly per Table 6 - Bolt Torque."
  10. If the bearings have not been replaced, reinstall the inboard bearing cover plate using the existing shim set. If the bearings have been replaced, use a **thicker** set of shims.
  11. Rotate the crankshaft by hand to verify free movement of the shaft.
    - a. If the crankshaft has an excessive amount of end play, too many shims have been used. Lateral crankshaft movement (end play) between the bearings should be:

End Play at Room Temperature
0.0015 to 0.0030" (0.038 to 0.076 mm)

- If necessary, remove shims until the end play is within tolerance.
- b. If the crankshaft binds, or will not turn, not enough shims have been used pushing the bearing cup too tight against the bearing cone. Remove the crankshaft from the crankcase and drive the inboard bearing cup out toward the inboard side of the crankcase. Reinstall the crankshaft and the bearing cover plate using additional shims as required.
12. Install the oil pump per the "Oil Pump Replacement" section of this manual.
  13. Reassemble the compressor according to the "Compressor Assembly" section.

## OIL PUMP REPLACEMENT

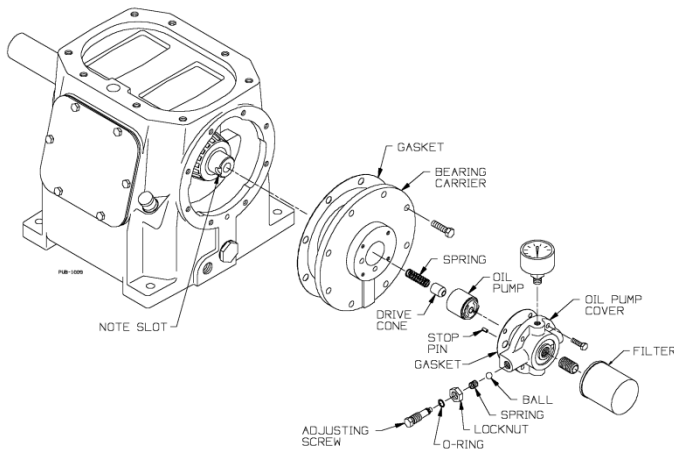

Figure 12 – Oil Pump

1. Remove the oil pump cover bolts and oil pump cover.
2. Remove the oil pump assembly, drive cone and spring.
3. Clean and inspect parts for wear or damage, replace as necessary.

4. Place the spring and the drive cone in the end of the crankshaft.
5. Note the slot in the end of the crankshaft and the drive tab on the back of the oil pump assembly. Install the oil pump assembly into the bearing carrier with the tab and slot aligned.
6. Note the groove around outer edge of the oil pump assembly and the stop pin in the oil pump cover. Position the oil pump cover and new gasket with the pin in the oil pump groove, rotating the oil pump as needed. The bolt hole positions ensure proper orientation of the oil pump cover.
7. **BY HAND**, tighten the oil pump cover bolts while the pump cover is held flush with the bearing carrier.  
**NOTICE: If by hand tightening, the oil pump cover cannot be drawn flush with the bearing carrier, the drive tab or the stop pin are improperly aligned. DO NOT WRENCH TIGHTEN OR THE OIL PUMP WILL BE DAMAGED.**
8. Once the oil pump cover is secured by hand, the bolts may be evenly tightened per Table 6 - "Bolt Torque."

## EXTENDED STORAGE AND MOVING PROCEDURES

If a compressor is not to be put into service for some time, or if a compressor is to be taken out of service for an extended period, care must be taken to protect the compressor. The following steps must be taken for both bare compressors and those already piped into a system.

**If proper storage and moving procedures are not followed, damage to the compressor may occur. Complete compressor disassembly and replacement of rod packing, bearings and other parts may be required.**

1. Keep a written record of storage procedures performed – preferably on the unit itself.
2. Fill the crankcase with rust inhibiting oil. (New compressors leave the factory without oil.) Squirt oil on the piston rods and crossheads through the nameplate opening. Loosen the V-belts to relieve the load on the bearings. Rotate the compressor by hand a few times to distribute the oil.
3. Plug all openings and purge the compressor with an inert gas such as nitrogen or **dry** air at about 50 psig (3.5 bar-g). This may be done at the factory if requested. Leave the compressor pressurized to prevent air or moisture from entering the unit.

Check the unit monthly and add additional purge gas as needed.

**NOTICE: Tag the unit with a warning that it is pressurized.**

4. If a purge gas is not available, fog oil into the compressor suction while rotating the unit. Then plug all openings to keep out moisture, insects, etc.
5. **Turn the flywheel by hand a few revolutions once a month to distribute the oil.**
6. Store the unit under a plastic wrap on its wooden shipping base up off the ground. If the unit was boxed for export shipment, leave it in its box. An indoor or covered storage area is preferable.
7. **Placing the Compressor back in service.**  
When the compressor is to be put in service, vent the remaining purge gas and change the crankcase oil. Follow the "Pre-Startup Checklist" and "Startup Procedure" sections in this manual.

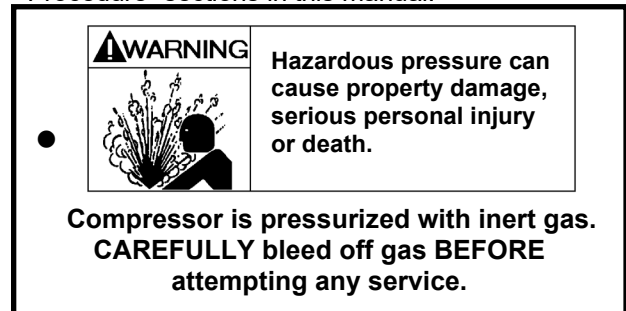

Figure 13 – Pressurized Compressor Tag

8. **If compressor is relocated**, follow the "Pre-Startup Checklist", "Startup Procedure" and "Installation" sections in this manual prior to putting in service.

## TROUBLESHOOTING

**Table 11 – Compressor Troubleshooting**

PROBLEM	STEP	PROBABLE CAUSE	WHAT TO CHECK	IF PROBLEM STILL EXISTS GO TO STEP ...
Low Transfer Rate	1	Worn or Broken Piston Rings	Check condition of rings by restricting discharge line. If pressure increases slowly, rings are probably faulty.	2
	2	Plugged Strainer	Clean screen as necessary.	3
	3	Compressor Valve Faulty	Remove and inspect for broken or worn springs, discs, or bodies.	4
	4	Liquid Relief Valves Need Adjusting	Adjust per instructions in "Valve Replacement."	5
	5	Compressor Drive Slipping	Tighten belts, check for sheared keys, loose keys or loose flywheel.	6
	6	Piping Improperly Designed or Installed	Use proper pipe sizes.	7
No Flow	7	Liquid Trap Full	Drain liquid trap through drain valve. Relieve vacuum through bleeder valve on top of liquid trap.	8
	8	Excess Flow Valves Slugged	Stop the compressor to let the excess flow open. Installation of a valved bypass line between the suction and discharge lines may be necessary.	5 & 6
Knocks or Other Noises	9	Loose Valves	Tighten valve hold-down screws.	10
	10	Worn Internal Parts	Inspect through inspection plates and repair as necessary.	3
No Oil Pressure	11	Oil Pump Relief Valve Not Properly Set.	Set oil pump relief valve.	12
	12	Oil Pump Not Working	Check the Oil Pump drive tab or stop pin for damage.	13
	13	Low Oil Level	Check and fill as necessary	14
	14	Dirty Inlet Strainer	Clean Inlet Strainer	--
Gas Leaking from Crankcase Breather	15	Faulty/Worn Packing	Replace Packing.	16
	16	Piston Rod Scored	Replace crosshead assemblies and packing.	17
	17	Improper Seal Arrangement	See "Seal Arrangements."	---
Relief Valve Actuates	18	Valve Closed Downstream of the Compressor	Open Valve	19
	19	Line Blockage Downstream of the Compressor	Locate Blockage and Correct	---
Shake or Vibration	20	Loose/Broken Mounting or Anchor Bolts	See "Mounting the Compressor Unit"	21
	21	Improper Mounting	Ensure base is supported full length. See "Mounting the Compressor."	22
	22	Improperly Aligned V-belt Sheaves	See "V-Belt Drives"	23
	23	Improperly Installed Flywheel	See "Compressor Flywheel"	24
	24	Nonfunctioning Valves	Replace or repair valves.	---

## **Notes**

(this page is intentionally left blank)

## **Notes**

(this page is intentionally left blank)



1809 Century Avenue, Grand Rapids, Michigan 49503 U.S.A.  
(616) 241-1611 • Fax: (616) 241-3752 • [www.blackmer.com](http://www.blackmer.com)