

BLACKMER LIQUEFIED GAS PUMPS

FOR CO₂ SERVICE TRUCK AND BASE MOUNTED INSTALLATION OPERATION AND MAINTENANCE INSTRUCTIONS MODELS: CRL2, CRL3, CRL3-OE1 DISCONTINUED MODELS: TCRL2, TCRL3

964480

INSTRUCTIONS NO. 701-B00

Section	701
Effective	Jan2019
Replaces	Jul 2018



SAFETY DATA



This is a SAFETY ALERT SYMBOL.

When you see this symbol on the product, or in the manual, look for one of the following signal words and be alert to the potential for personal injury, death or major property damage



Warns of hazards that WILL cause serious personal injury, death or major property damage.



Warns of hazards that CAN cause serious personal injury, death or major property damage.



Warns of hazards that CAN cause personal injury or property damage.

NOTICE:

Indicates special instructions which are very important and must be followed.

TABLE OF CONTENTS

Page

PUMP DATA

Technical Data	2
Initial Pump Start Up Information.....	2

INSTALLATION

Pre-Installation Cleaning	3
Location and Piping.....	3
Pump Relief Valve and Bypass valve.....	4
Check Valves	4
Mounting	4
Pump Drives.....	4
Coupling Alignment	4
Flange Mounted Gear Reducer	5
V-Belt	6
PTO.....	6
Hydraulic	6
Pump Rotation.....	7
To Change Pump Rotation.....	7

OPERATION

Pre-Start Up Check List.....	8
Start Up Procedures.....	8

MAINTENANCE

Strainers.....	9
Lubrication.....	9
Vane Replacement.....	10
Pump Disassembly	10
Parts Replacement.....	10
Pump Assembly	11

FLANGE MOUNTED GEAR REDUCER MAIN.....	13
TROUBLE SHOOTING	11

NOTE: Numbers in parentheses following individual parts indicate reference numbers on Blackmer Parts List No. 701-B01.

Blackmer pump manuals and parts lists may be obtained from Blackmer's website (www.blackmer.com) or by contacting Blackmer Customer Service.

NOTICE:

Blackmer CO₂ pumps MUST only be installed in systems which have been designed by qualified engineering personnel. The system MUST conform to all applicable local and national regulations and safety standards.

This manual is intended to assist in the installation and operation of the Blackmer CO₂ pumps, and MUST be kept with the pump.

Blackmer CO₂ pump service shall be performed by qualified technicians ONLY. Service shall conform to all applicable local and national regulations and safety standards.

Thoroughly review this manual, all Instructions and hazard warnings, BEFORE performing any work on the Blackmer CO₂ pumps.

Maintain ALL system and Blackmer liquefied gas pump operation and hazard warning decals.

SAFETY DATA

⚠ WARNING



Hazardous machinery can cause serious personal injury.

Failure to disconnect and lockout electrical power or engine drive before attempting maintenance can cause severe personal injury or death

⚠ WARNING



Hazardous voltage. Can shock, burn or cause death.

Failure to disconnect and lockout electrical power before attempting maintenance can cause shock, burns or death

⚠ WARNING



Hazardous pressure can cause serious personal injury or property damage

Disconnecting fluid or pressure containment components during pump operation can cause serious personal injury or property damage.

⚠ WARNING



Hazardous pressure can cause serious personal injury or property damage

Failure to relieve system pressure prior to performing pump service can cause serious personal injury or property damage. Systems with meters will still be pressurized even after the hose is emptied

⚠ WARNING



Hazardous or toxic fluids can cause serious injury.

If pumping hazardous or toxic fluids, system must be flushed and decontaminated, inside and out, prior to performing service or maintenance

⚠ WARNING



Hazardous machinery can cause severe personal injury or property damage.

Failure to set the vehicle emergency brake and chock wheels before performing service can cause severe personal injury or property damage.

⚠ WARNING



Do not operate without guard in place

Operation without guards in place can cause serious personal injury, major property damage, or death.

PUMP DATA

PUMP IDENTIFICATION

A pump Identification tag, containing the pump serial number, I.D. number, and model designation, is attached to each pump. It is recommended that the data from this tag be recorded and filed for future reference. If replacement parts are needed, or if information pertaining to the pump is required, this data must be furnished to a Blackmer representative.

TECHNICAL DATA

	CRL2 TCRL2	CRL3 TCRL3 CRL3-OE1
Maximum Pump Speed	640 RPM	640 RPM
Minimum Operating Temperature	-30°F (-34°C)	-30°F (-34°C)
Maximum Differential Pressure	100 psi (6.9 Bar)	100 psi (6.9 Bar)
Maximum Working Pressure	525 psi (36.2 Bar)	525 psi (36.2 Bar)

* Technical Data is for standard materials of construction. Consult Blackmer Material Specs for optional materials of construction.

INITIAL PUMP START UP INFORMATION

Model No.:	_____
Serial No.:	_____
ID No.:	_____
Date of Installation:	_____
Inlet Gauge Reading:	_____
Discharge Gauge Reading:	_____
Flow Rate:	_____

INSTALLATION

NOTICE:

Blackmer pumps must only be installed in systems designed by qualified engineering personnel. System design must conform with all applicable regulations and codes and provide warning of all system hazards.

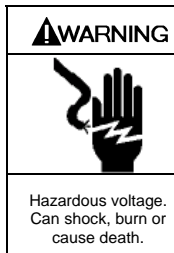

- ⚠️ Install, ground and wire to local and National Electrical Code requirements.
- ⚠️ Install an all-leg disconnect switch near the unit motor.
- ⚠️ Disconnect and lockout electrical power before installation or service
- ⚠️ Electrical supply **MUST** match motor nameplate specifications.

⚠️ Motors equipped with thermal protection automatically disconnect motor electrical circuit when overload exists. Motor can start unexpectedly and without warning.

NOTICE:

Pump with welded connections contain three non-metallic o-ring seals that will be damaged if welding is done with these o-rings installed.

Prior to welding the piping, remove the O-rings from under the inlet flange, outlet flange and relief valve cover as indicated in Figure 1.

Reinstall the inlet and outlet flanges. Weld the piping to the the inlet and outlet flanges. After the welding is complete, reinstall the O-rings.

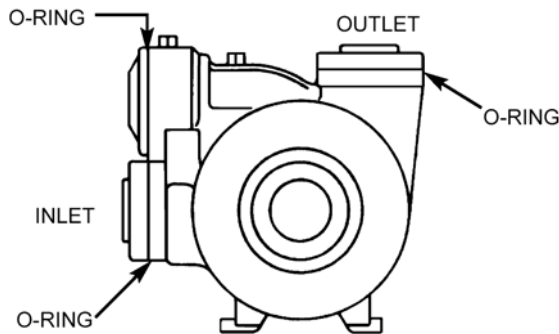

Figure 1 – Flange O-Rings

PRE-INSTALLATION CLEANING

NOTICE:

New pumps **might** contain residual test fluid and/or rust inhibitor. If necessary, flush pump prior to use.

Foreign matter entering the pump WILL cause extensive damage. The supply tank and intake piping **MUST** be cleaned and flushed prior to pump installation and operation.

LOCATION AND PIPING

Pump life and performance will be significantly reduced when installed in an improperly designed system. Before starting the layout and installation of the piping system, review the following suggestions:

1. Locate the pump as near as possible to the source of supply to avoid excessive inlet pipe friction.
2. The inlet line should be at least as large as the intake port on the pump. It should slope downward to the pump, and should not contain any upward loops. Eliminate restrictions such as sharp bends; globe valves, unnecessary elbows, and undersized strainers.
3. It is recommended a strainer be installed in the inlet line to protect the pump from foreign matter. The strainer should be located at least 24" (0.6m) from the pump, and have a net open area of at least four times the area of the intake piping. Strainers must be cleaned regularly to avoid pump starvation.
4. The intake and discharge piping system must be free of all leaks.
5. Expansion joints, placed at least 36" (0.9m) from the pump, will compensate for expansion and contraction of the pipes. Contact the flexible connector/hose manufacturer for required maintenance/care and design assistance in their use.
6. Install pressure gauges in the NPT ports provided in the pump casing to check pump performance at start up.
7. ALL piping and fittings **MUST** be properly supported to prevent any piping loads from being placed on the pump.
8. Check alignment of pipes to pump to avoid strains which might later cause misalignment. See Figure 2. Unbolt flanges or break union joints. Pipes should not spring away or drop down. After pump has been in operation for a week or two, completely recheck alignment.

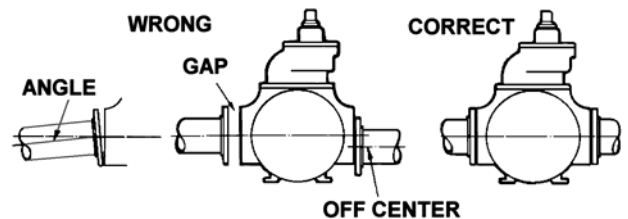

Figure 2

9. The use of a vapor return line will speed up delivery by preventing back pressure from building up at the receiving tank and pressure reduction in the supply tank.
10. Keeping the liquefied gas systems full of liquid, even when idle, will keep the O-rings from changing shape, shrinking or super cooling. Evaporation of liquefied gas leaves an abrasive powder on the surface which can cause wear to the pump, meter, and seals.

INSTALLATION

PUMP RELIEF VALVE AND BYPASS VALVE

NOTICE:

The pump internal relief valve is designed to protect the pump from excessive pressure and must not be used as a system pressure control valve.

For ALL liquefied gas applications, install an external bypass valve, and any necessary piping, back to the tank. DO NOT pipe the bypass valve back to the intake line. The setting on the external bypass valve must be at least 25 psi (1.7 bar) lower than the pump internal relief valve setting. The valve and piping must be of adequate size to accommodate the full flow from the pump when the discharge line is closed. The non-adjustable pump internal relief valve is factory set at approximately 150 PSI (10.3 bar).

The 'Alternate Discharge to Storage Tank' line and manual valve may be used to unload transports without pumps into the storage tank. The manual valve in this line must remain closed during all other operations.

Refer to Blackmer Bypass Valve Installation and Maintenance Instructions for bypass valve settings and adjustments.

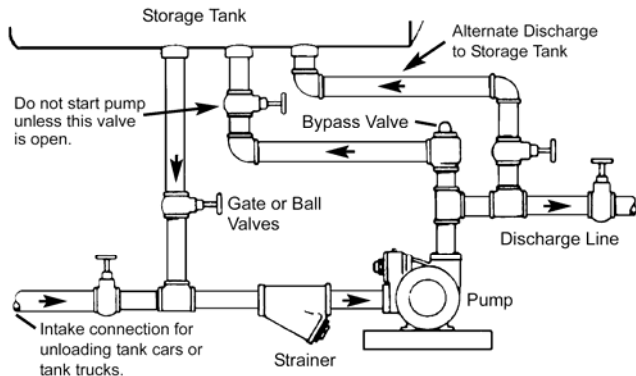

Figure 3 - Bypass Valve Mounting

CHECK VALVES

The use of check valves or foot valves in the supply tank is not recommended with self-priming, positive displacement pumps.

If the possibility of liquid backflow exists when the pump is off, a check valve in the pump discharge piping is recommended because the pump can motor in the reverse rotation and create undue stress on all attached components. Never start a pump when it is rotating in the reverse rotation as the added starting torque can damage the pump and related equipment.

PUMP MOUNTING

Stationary Pumps

A solid foundation reduces noise and vibration, and will improve pump performance. On permanent installations it is recommended the pumping unit be secured by anchor bolts as shown in Figure 4. This arrangement allows for slight shifting of position to accommodate alignment with the mounting holes in the base plate.

For new foundations, it is suggested that the anchor bolts be set in concrete. When pumps are to be located on existing concrete floors, holes should be drilled into the concrete to hold the anchor bolts.

Figure 4 - Pipe Type Anchor Bolt Box

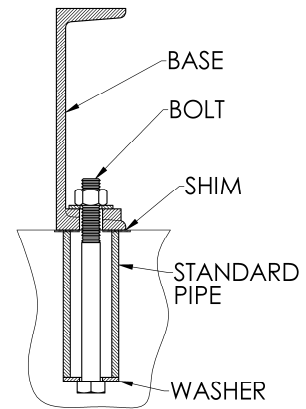

When installing units built on channel or structural steel type bases, use care to avoid twisting the base out of shape when anchor bolts are tightened. Shims should be used under the edges of the base prior to tightening of the anchor bolts to prevent distortion.

Truck Mounted Pumps

CRL pump models can be bolted to the truck frame or on a saddle hung below the frame, and MUST be adequately supported.

PUMP DRIVES

Stationary pumps are typically driven via a V-belt drive or via a flexible coupling and gear reducer. Truck mounted pumps are typically driven via the truck's PTO drive or via a hydraulic motor.

COUPLING ALIGNMENT – LONG COUPLED

The pump must be directly coupled to a gear and/or driver with a flexible coupling. Verify coupling alignment after installation of new or rebuilt pumps. Both angular and parallel coupling alignment MUST be maintained between the pump, gear, motor, etc. in accordance with manufacturer's instructions. See Figure 5.

1. Parallel alignment: The use of a laser alignment tool or dial indicator is preferred. If a laser alignment tool or dial indicator is not available, use a straightedge. Turn both shafts by hand, checking the reading through one complete revolution. Maximum offset should be less than .005" (.127 mm).
2. Angular alignment: Insert a feeler gauge between the coupling halves. Check the spacing at 90° increments around the coupling (four checkpoints). Maximum variation should not exceed .005" (.127 mm). Some laser alignment tools will check angular alignment as well.
3. Replace the coupling guards after setting alignment.

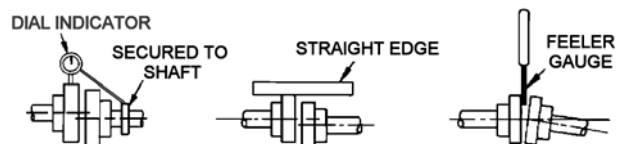

Figure 5 - Coupling Alignment

INSTALLATION

ALIGNMENT – FLANGE MOUNTED GEAR REDUCER

If the unit is assembled with a Blackmer Flange Mounted Gear Reducer, no coupling alignment is required. The motor, gearbox, and pump are rigidly connected with bolted, flange connections. These flanges ensure the motor shaft, gearbox shafts, and pump shaft are aligned correctly, without the need for manual alignment. However, due to variations in base and foundation geometry the unit will require shimming to reduce stress on the gearbox and pump adapter. See *PRESTART CHECKLIST* section for details.

V-BELT DRIVE

For installation of Blackmer V-belt units, first mount the pump and the motor base to the unit base. Do not fully tighten the motor mounting bolts until properly installing and adjusting the belts as follows:

1. Wipe the cone surface of the pump QD hub (152A) and the inside of the pump sheave hub with a clean cloth moistened with a light grade of machine oil. This will allow for a more uniform draw and prevent the cone surfaces from “freezing” before being tightened.
2. With the pump shaft key (35) in place, align the key seat and slide the QD hub (152A) on the shaft, flange end first. Slide the large end of the sheave (152) bore over the taper on the QD hub. Insert the three sheave capscrews (152G) through the clearance holes in the sheave, and start them into the tapped holes of the QD hub (152A). Repeat this procedure to assemble the motor QD hub (152E) and sheave (152D).
3. To install the belts (181), shorten the center distance of the drive by moving the motor towards the pump, until the the belts can be put on the sheaves (152 & 152D) without forcing.
4. Align the sheaves so that the faces are parallel, then snug up the sheave capscrews (152C & G).
5. Measure the span length as shown in Figure 6.

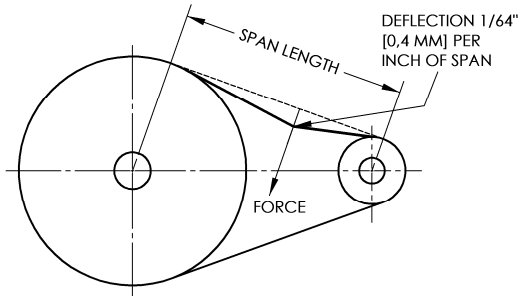

Figure 6 – V-Belt Adjustment

6. Adjust the motor base (183) and apply a specified force (refer to Table 1) against the belt, at the center of the span, so that the belt is deflected 1/64 inch (0.04 mm) for every inch (25.4 mm) of span. For example, the deflection of a 20 inch (508 mm) span would be 20/64 or 5/16 inch (7.9 mm). The force required should be within the range given in Table 1 for a properly tensioned drive. A new set of belts should be initially tensioned to the upper limit.

Table 1 – V-Belt Deflection

SMALL SHEAVE OUTSIDE DIAMETER	BELT DEFLECTION FORCE	
	Minimum	Maximum
2.5" to 4.5" (63.5 mm to 114.3 mm)	3.0 lbs. (1.4 kgs.)	4.75 lbs. (2.2 kgs.)
4.75" to 7.0" (120.7 mm to 177.8 mm)	4.0 lbs. (1.8 kgs.)	6.0 lbs. (2.7 kgs.)

7. Check again to ensure the sheaves (152 & 152D) are parallel, then tighten the sheave capscrews (152C & 152G), the motor mounting nuts (183B) and the adjusting screw locknut (183B).
8. Assemble the belt guard (182) and the belt guard brace (182A) to the unit base (32).

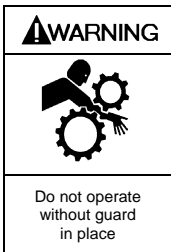

Operation without guards in place can cause serious personal injury, major property damage, or death.

9. Check the belt tension after 24-48 hours of operating. Recheck the tension periodically and tighten the belts as required. **DO NOT** overtighten belts. Inspect belts periodically for signs of excessive wear, and replace as required.

V-BELT DISASSEMBLY

1. Remove the belt guard (182) and the guard base (182A).
2. Loosen the adjusting screw locknut (183B) on the motor base (183) and the motor mounting nuts.
3. Ease the tension on the belts (181) by moving the motor towards the pump to shorten the center distance of the drive. Remove the belts by sliding them over the sheaves (152 & 152D). **DO NOT** force the belts over the grooves.
4. To remove the sheave from the hub, first remove the three sheave capscrews (152C or 152G). Then screw two of the capscrews into the threaded holes in the sheave hub (152A or E). If the cone grip is hard to break loose, tap the end of the shaft or the QD hub with soft-faced mallet while maintaining pressure on the screw.
5. The QD hub should slide smoothly off the shaft. If it is tight on the shaft, gently pry it loose with a screwdriver or a small wedge placed in the split part of the flange.

Refer to **Blackmer V-Belt Parts List and Instructions for V-belt drive and guard part numbers.**

PTO DRIVE

The pump may be driven by a power take-off through universal joints. When using universal joints, a splined slip joint, properly lubricated, must be used on the connecting jack shaft to prevent end thrust on the pump shaft.

A proper drive line must be installed to avoid excessive wear, vibration and noise (see Figure 7 and Table 2).

General guidelines to follow for proper pump drive:

1. Do not use square slip joints.
2. Use the least number of jack shafts as is practical.
3. Use an even number of universal joints.
4. The pump shaft and power take-off shaft must be parallel in all respects. Use an angular level measuring device to ensure the PTO and pump shaft are parallel to each other. If necessary, the pump can be shimmed to correct any misalignment. The PTO shaft coming off at the transmission does not need to be perfectly horizontal as long as the pump is shimmed to have its shaft parallel in all respects to the PTO shaft.
5. The yokes of the universals at both ends of the jack shaft must be parallel and in phase.
6. The maximum recommended angle between the jack shaft and the pump shaft is 15 degrees. See Table 1.

Failure to follow any of these guidelines may result in a gallop or uneven turning of the pump rotor, which will in turn cause a

surging vibration to the liquid stream and piping system. Contact the supplier of the drive line components for specific design assistance.

PTO driven units **MUST** contain speed control devices to prevent pump speeds above the maximum RPM specifications, regardless of the truck engine unloading speeds. Should fluid delivery be appreciably less than expected, see the "General Pump Troubleshooting" section.

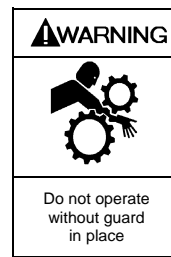

A drive shaft guard between the pto and pump must be provided to prevent personal injury, property damage, or death.

Table 2 - Angle of Drive Shaft

1°through 5°	6°through 10°	11°through 15°
Very Good	Good	Fair

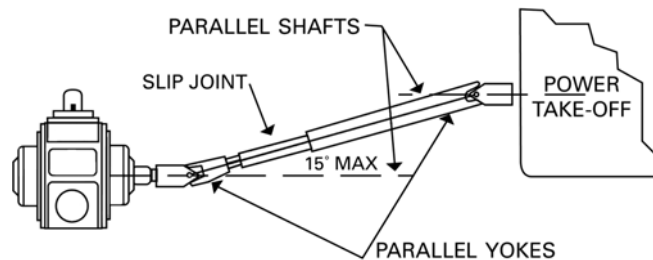

NOTE: A Drive Shaft Guard between the pump and the PTO MUST be provided. (Not shown)
Figure 7 – PTO Drive

HYDRAULIC DRIVE

Truck mounted pumps may also be driven hydraulically. Hydraulic motors should be well supported with their shafts parallel to the pump shaft in all respects. Blackmer provides an optional close-coupled hydraulic motor adapter. The adapter provides for straight alignment of a hydraulic motor drive through a solid coupling connected to a straight key pump shaft. This coupling connection requires grease lubrication every three months at **minimum**. Refer to the "Lubrication" section of this manual.

Hydraulically driven units **MUST** contain speed control devices to prevent pump speeds above the maximum RPM specifications, regardless of the truck engine unloading speeds. Should fluid delivery be appreciably less than expected, see the "General Pump Troubleshooting" section.

INSTALLATION

shaft. The shaft protector (186) MUST be mounted over the non-driven shaft end.

PUMP ROTATION

NOTICE:

Confirm correct pump rotation by checking the pump rotation arrows respective to pump driver rotation.

TO CHANGE PUMP ROTATION

Blackmer 2 and 3" CRL pump models are equipped with a double ended rotor and shaft, enabling them to be driven from either shaft end. To change rotation, rotate the pump 180 degrees so that the opposite shaft becomes the driven

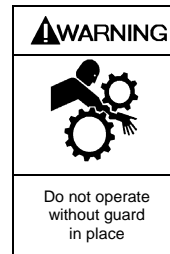

Operation without guards in place can cause serious personal injury, major property damage, or death.

OPERATION

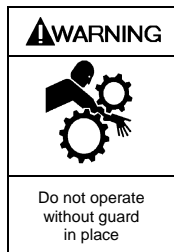

Operation without guards in place can cause serious personal injury, major property damage, or death.

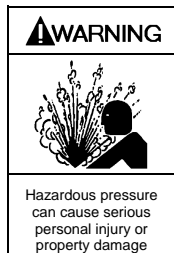

Failure to relieve system pressure prior to performing pump service can cause serious personal injury or property damage. Systems with meters will still be pressurized even after the hose is emptied

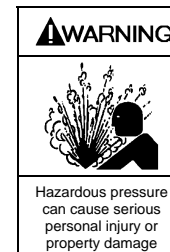

Disconnecting fluid or pressure containment components during pump operation can cause serious personal injury or property damage.



Pumps operating against a closed valve can cause system failure, personal injury and property damage

OPERATION

PRE-STARTUP CHECK LIST

1. Check the alignment of the pipes to the pump. Pipes should be supported so that they do not spring away or drop down when pump flanges or union joints are disconnected.
2. Verify proper coupling or V-belt alignment.
3. For units assembled with a Blackmer Flange Mounted Gearbox:
 - 3a. Bolt down the pump foot, while supporting the motor with an appropriate lifting device (e.g. crane)
 - 3b. Place a .125" thick shim under each of the motor mounting holes
 - 3c. Slowly lower the motor until it is unsupported
 - 3d. Try pulling out each of the shims, while noticing the pull tension
 - 3e. If the shims closest to the motor shaft easily pull out, increase the shim thickness the same at all locations and recheck
 - 3f. If the shims furthest from the motor shaft easily pull out, decrease the shim thickness the same at all locations and recheck
 - 3g. The unit is properly shimmed when all 4 motor shims have the same amount of tension when pulled
 - 3h. Bolt down the motor with the appropriate fastener.
4. Blackmer Flange Mounted Gearboxes will be shipped with Mobil SHC630 synthetic oil. If replacing the oil, refer to the **FLANGE MOUNTED GEAR REDUCER MAINTENANCE** section.
5. Blackmer helical gear reducers (if supplied) are shipped from the factory without oil in the gearcase. Fill with the grade of oil indicated on the reducer tag. For more specific instructions on Blackmer gear reducers, refer to the appropriate Gear reducer Installation, Operation and Instruction Manual.
6. Check the entire pumping system to verify that the proper inlet and discharge valves are fully open, and that the drain valves and other auxiliary valves are closed.
7. Ensure that any hoses are properly secured.
8. Install suction and discharge pressure gauges on the pump in the threaded connections provided. These can be used to check actual suction and discharge conditions after pump start-up.
9. Check the wiring of the motor.
10. Briefly start the pump to make sure the pump rotates in the direction of the rotation arrow.

5. Check for excessive noise, vibration or overheating of the pump, reducer, and motor.
6. If possible, check the flow rate.
7. Close the discharge valve and check the differential pressure across the pump. Pressure must not exceed the pressure setting of the external bypass valve.
8. With the discharge valve still closed, momentarily close the manual shut-off valve in the bypass return line to check the pump internal relief valve. The differential pressure should be 150 - 170 psi (10.3 - 11.7 bar).
9. The external bypass valve must always be set at least 25 psi (1.7 bar) lower than the internal pump relief valve. NOTE: The normal operating pressure must be at least 5 - 15 psi (0.3 - 1.0 bar) less than the external bypass valve setting. Pump speeds which result in higher pressures (nearing the valve setting) forces the liquid to recirculate, creating excessive wear on the pump and equipment.

Truck Pumps

1. Open the shut-off valve in the bypass return line.
2. If the tank outlet valve is:
 - a. Lever Operated - Pull the control knob all the way out. Manually check the lever under the truck to see that it is in the completely OPEN position.
 - b. Discharge Pressure Operated - Keep the discharge line valve closed. When pump is started, it will build up enough pressure to open the tank outlet valve. NOTE: This type of valve usually requires approximately 20 psi (1.4 bar) differential pressure to open and approximately 15 psi (1.0 bar) differential pressure to keep it open. If the piping is quite large, it may be necessary to restrict the discharge line shut-off valve in order to maintain sufficient pressure to keep the tank outlet valve open.
3. Start the pump. Confirm proper pump rotation by checking the pump rotation arrows.
4. Check the pump speed. Pump speed must never exceed the recommended maximum. Refer to "Technical Data" section of this manual.
5. Check the pressure gauges to ensure the system is operating within expected parameters. Record the gauge readings in the "Initial Start Up Information" section of this manual for future reference.
6. Inspect piping, fittings, and associated system equipment for leaks, noise, vibration and overheating.
7. Check the flow rate to ensure the pump is operating within the expected parameters. Record the flowrate in the "Initial Start Up Information" section of this manual.
8. Close the discharge valve and check the differential pressure across the pump. It must not exceed the pressure setting of the external bypass valve.
9. With the discharge valve still closed, momentarily close the manual shut-off valve in the bypass return line to check the internal pump relief valve. The differential pressure should be 150 to 170 psi (10.3 to 11.7 bar).
10. The external bypass valve must always be set at least 25 psi (1.7 bar) lower than the pump internal relief valve. NOTE: The normal operating pressure must be at least 5 - 15 psi (0.3 - 1.0 bar) less than the external bypass valve setting. Pump speeds which result in higher pressures (nearing the valve setting) forces the liquid to recirculate, creating excessive wear on the pump and equipment.

STARTUP PROCEDURES

NOTICE:

Consult the "General Pump Troubleshooting" section of this manual if difficulties during start up are experienced.

Stationary Pumps

1. SLOWLY build pressure in the pump.
2. Start the pump. Priming should occur within one minute.
3. Check the suction and discharge pressure gauges to see if the pump is operating within the expected conditions.
4. Check for leakage from the piping and equipment.

MAINTENANCE

⚠WARNING



Hazardous machinery can cause serious personal injury.

Failure to disconnect and lockout electrical power or engine drive before attempting maintenance can cause severe personal injury or death

⚠WARNING



Hazardous voltage. Can shock, burn or cause death.

Failure to disconnect and lockout electrical power before attempting maintenance can cause shock, burns or death

⚠WARNING



Hazardous pressure can cause serious personal injury or property damage

Disconnecting fluid or pressure containment components during pump operation can cause serious personal injury or property damage.

⚠WARNING



Hazardous pressure can cause serious personal injury or property damage

Failure to relieve system pressure prior to performing pump service can cause serious personal injury or property damage. Systems with meters will still be pressurized even after the hose is emptied

⚠WARNING



Hazardous or toxic fluids can cause serious injury.

If pumping hazardous or toxic fluids, system must be flushed and decontaminated, inside and out, prior to performing service or maintenance

⚠WARNING



Hazardous machinery can cause severe personal injury or property damage.

Failure to set the vehicle emergency brake and chock wheels before performing service can cause severe personal injury or property damage.

NOTICE:

Maintenance shall be performed by qualified technicians only. Following the appropriate procedures and warnings as presented in this manual.

SCHEDULED MAINTENANCE

STRAINERS

Strainers must be cleaned regularly to avoid pump starvation. Schedule will depend upon the application and conditions.

LUBRICATION

NOTICE:

To avoid possible entanglement in moving parts do not lubricate pump bearings, gear reducer or any other parts while the pump is running.

NOTICE:

If pumps are repainted in the field, ensure that the grease relief fittings (76A) are functioning properly after painting. Do NOT paint them closed. Remove any excess paint from the fittings.

Pump bearings should be lubricated every one to twelve weeks (AT MINIMUM), depending on the application, and operating conditions.

Recommended Grease:

Dow Corning® - MOLYKOTE 44
DuPont® - KRYTOX GPL 203

Greasing Procedure:

1. Remove the grease relief fittings (76A) from the bearing covers (27A).
2. **SLOWLY** apply grease with a hand gun until grease begins to escape from the grease relief fitting port.
3. Replace the grease relief fittings (76A).

DO NOT overgrease pump bearings. While it is normal for some grease to escape from the grease tell-tale hole after lubrication, excessive grease on pumps equipped with mechanical seals can cause seal failure.

IF EQUIPPED: Blackmer gear reducers are shipped from the factory without oil in the gearcase. Fill with the grade of oil indicated on the reducer tag. The oil should be changed after the first 48 hours of use and approximately every 500 hours of use thereafter.

MAINTENANCE

VANE REPLACEMENT

NOTICE:

Maintenance shall be performed by qualified technicians only. Following the appropriate procedures and warnings as presented in manual.

1. Drain and relieve pressure from the pump and system as required.
2. Remove the head assembly from the outboard (non-driven) side of the pump according to steps 4 - 9 in the "Pump Disassembly" section of this manual.
3. Turn the shaft by hand until a vane (14) comes to the top (12 o'clock) position of the rotor. Remove the vane.
4. Install a new vane (14), ensuring that the rounded edge is UP, and the relief grooves are facing towards the direction of rotation. See Figure 8.
5. Repeat steps 3 and 4 until all vanes have been replaced.
6. Reassemble the pump according to the "Pump Assembly." section of this manual.

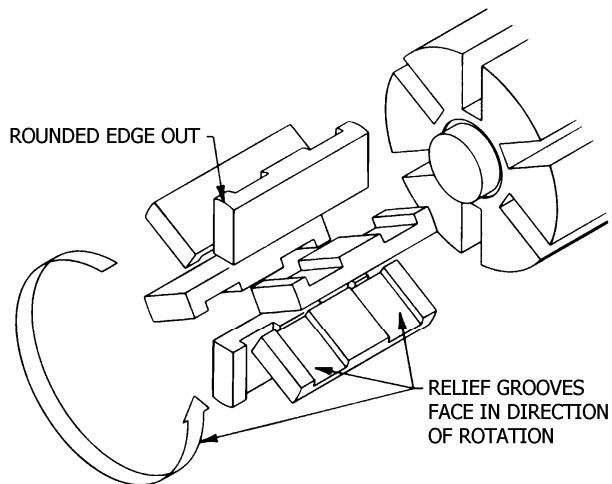

Figure 8 – Vane Replacement

PUMP DISASSEMBLY

NOTICE:

Follow all hazard warnings and instructions provided in the "maintenance" section of this manual.

NOTE: The numbers in parentheses following individual parts indicate reference numbers on the Pump Parts List.

1. Drain and relieve pressure from the pump and system as required.
2. Starting on the inboard (driven) end of the pump, clean the pump shaft thoroughly, making sure the shaft is free of nicks and burrs. This will prevent damage to the mechanical seal when the inboard head assembly is removed.
3. Remove the inboard bearing cover capscrews (28) and slide the inboard bearing cover (27) and gasket (26) off the shaft. Discard the bearing cover gasket. On the 2-inch models, the dirt shield (123A) will come off with the bearing cover.

4. Remove the outboard bearing cover capscrews (28) and slide the outboard bearing cover (27) and gasket (26) off the shaft. Discard the bearing cover gasket. On the 2-inch models, the dirt shield (123A) will come off with the bearing cover.
5. To remove locknuts and lockwashers (24A and 24B):
 - a. Bend up the engaged lockwasher tang and rotate the locknut (24A) counterclockwise to remove it from the shaft
 - b. Slide the lockwasher (24B) off the shaft. Inspect the lockwasher for damage and replace as required.
 - c. Repeat steps a and b on the opposite shaft end.
6. Remove the head capscrews (21) and carefully pry the head (20) away from the casing (12).
7. Slide the head (20) off the shaft. The head O-ring (72), bearing (24), mechanical seal stationary seat and stationary O-ring (153A & 153D) will come off with the head assembly. Remove and discard the head O-ring.
 - a. Pull the bearing (24) from the housing in the head (20).
 - b. To remove the mechanical seal stationary seat (153A), use the blunt end of a screw driver to gently push the backside of the stationary seat from the head. Place a cloth under the seal to avoid damage. Be careful not to contact the polished face of the seal during removal. Remove and discard mechanical seal stationary O-ring.
8. Carefully pull the rotating seal assembly, consisting of seal jacket (153C), rotating seal face and rotating O-ring (153B & 153E) from the shaft. Remove and discard the rotating O-ring (153E).
9. Carefully remove the disc (71).
10. Carefully pull the rotor and shaft (13) from the casing (12). While one hand is pulling the shaft, cup the other hand underneath the rotor to prevent the vanes (14) and push rods (77) from falling out. Carefully set the rotor and shaft aside for future vane replacement and reassembly. **NOTICE:** The rotor and shaft weighs approximately 34 pounds (15 kg). Be careful not to pinch the hand under the rotor and shaft when removing from casing.
11. Lay the pump flat with the remaining head (20) facing upward to remove the head assembly mechanical seal (153) and disc (71) from the outboard side of the pump, as instructed in steps 6 - 9 above. 12. If necessary, remove the liner (41) by tapping around the outside diameter of the liner with a hard wood drift and a hammer until it is driven from the casing (12).

PARTS REPLACEMENT

1. If any of the O-rings have been removed or disturbed during disassembly, they be replaced with new O-rings. **NOTE:** PTFE O-rings should be heated in hot water to aid installation.
2. Excessive or continuous leakage from the tell-tale hole in the bearing cover may be an indication of a damaged mechanical seal. If a mechanical seal has been leaking, it is recommended the entire seal be replaced. Refer to "General Pump Troubleshooting" for possible causes of seal leakage.

MAINTENANCE

PUMP ASSEMBLY

Before reassembling the pump, inspect all component parts for wear or damage, and replace as required. Wash out the bearing/seal recess of the head and remove any burrs or nicks from the rotor and shaft.

Reassemble the **OUTBOARD** side of the pump first:

1. On 2-inch pump models, apply grease to the liner key groove in the pump casing to hold the key (74) in place during liner installation. Install key in groove before starting liner (41) into pump casing (12). On 3-inch pump models, install the liner key (74) in the groove on top of the liner (41).
2. Align the liner key (74) with the pump casing keyway and start the liner (41) into the casing (12) with the slots in the liner towards the INTAKE port, and the hole pattern in the liner towards the DISCHARGE port. Uniformly tap the outer edge of the liner with a rubber mallet to fully insert into the casing. NOTE: If the liner is installed backwards, it will restrict the port openings and cause cavitation, noise and loss of capacity.

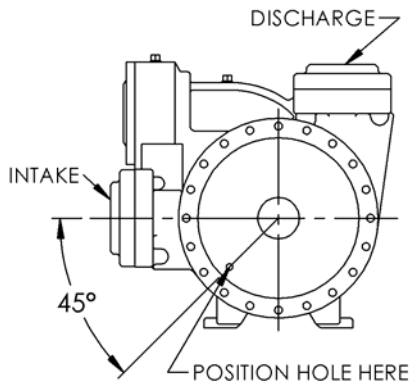
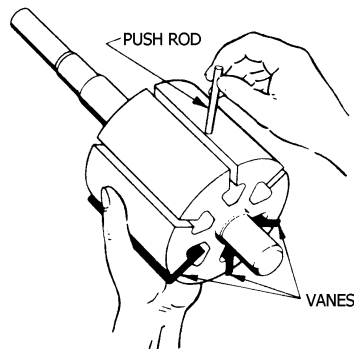

Figure 9 – Disc Relief Hole Location

3. Place the disc (71) against the liner (41) with the seal cavity outward and disc relief hole located as shown in Figure 9.
4. Without installing the head O-ring or mechanical seal components, temporarily attach the outboard head (20) and bearing (24) to the casing (12). Install and handtighten two head capscrews (21), 180 degrees apart. This head will be used to hold and align the rotor and shaft (13) while the inboard side of the pump is assembled.
5. Remove the vanes (14) and push rods (77) from the rotor and shaft assembly (13). Inspect for wear and damage, and replace as follows:

Figure 10 – Pushrod Installation



- a. Partially install the non-driven end of the rotor and shaft (13) into the open side of the pump casing (12).

- b. Leave part of the rotor outside of the casing (12) so that the bottom vanes (14) can be installed and held in place as the push rods (77) are installed in the push rod holes of the rotor. Insert the new vanes into the rotor slots with the rounded edges outward, and the vane relief grooves facing TOWARDS the direction of rotation. See Figure 10.
 - c. After the bottom vanes and push rods are installed, insert the rotor and shaft (13) fully into the casing (12).
 - d. Install the remaining vanes (14) into the top positions of the rotor.
6. Install the disc (71) on the inboard side of the pump with the seal cavity facing outward and the disc relief hole located as shown in Figure 9.
 7. Install a new head O-ring (72) in the groove on the inside face of the head (20). Lay the O-ring flat and start in on one side of the groove, stretching ahead with the fingers, as shown in Figure 11.

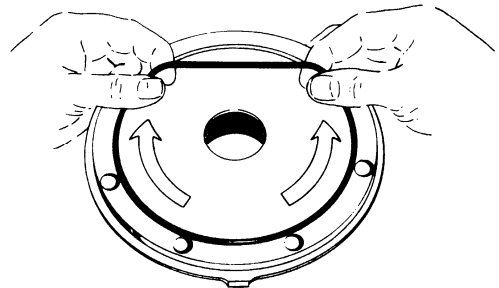

Figure 11 – Head O-Ring Installation

8. MECHANICAL SEAL INSTALLATION

Rotating Assembly -

- a. Apply a small amount of motor oil on the shaft between the shaft threads and the rotor.
- b. Slide the seal jacket assembly (153C) over the shaft and into the disc cavity with the drive tangs of the jacket towards the rotor. Rotate the jacket assembly to engage the drive tangs in the rotor slots.
- c. Install a new rotating O-ring (153E) in the rotating seal face (153B). Align and insert the rotating assembly into the the seal jacket with the polished face outward. Clean the polished face with a clean tissue and alcohol.

Stationary Seat -

- a. Apply a small amount of motor oil in the seal recess of the head (20).
 - b. Install a new stationary O-ring (153D) in the stationary seat (153A). Align the pin in the stationary seat with the slot in the head recess and push the seat fully into the seal recess with the polished face outward. Clean the polished face with a clean tissue and alcohol.
9. Carefully install the head assembly (20) over the shaft. Do not contact the end of the shaft with the polished face of the stationary seat. Rotate the head so that the drain hole (tell-tale hole), located at the back of the bearing cavity, faces downward when the pump is mounted for operation. Install and uniformly tighten four head capscrews (21) 90° apart, torquing to 30 lbs ft (40.7 Nm).
 10. Hand pack the ball bearing (24) with grease. Refer to the "Lubrication" section for the recommended grease.

MAINTENANCE

11. Install the bearing (24) into the head recess. The bearing balls should face outward, with the grease shield inward. Ensure the bearing is fully and squarely seated in the head (20).
12. Turn the pump casing around and remove the outboard head previously attached.
13. Install the outboard head (20), mechanical seal (153) and bearing (24) as instructed in steps 6 through 11.
14. Rotate the shaft by hand to engage the mechanical seal drive tangs, and to test for binding or tight spots. If the rotor does not turn freely, lightly tap the rims of the heads with a soft faced mallet until the correct position is found. Install all of the remaining head capscrews (21) for each head (20) and uniformly torque to 30 lbs ft (40.7 Nm).

15. LOCKNUT ADJUSTMENT

It is important that the bearing locknuts (24A) and lockwashers (24B) be installed and adjusted properly. Overtightening locknuts can cause bearing failure or a broken lockwasher tang. Loose locknuts will allow the rotor to shift against the discs (71), causing wear. See Figure 12.

- a. On both ends of the pump shaft, Install a lockwasher (24B) with the tangs facing outward, followed by a locknut (24A) with the tapered end inward. Ensure the inner tang "A" of the lockwasher is located in the slot in the shaft threads, bending it slightly, if necessary.
- b. Tighten both locknuts (24A) to ensure that the bearings (24) are bottomed in the head recess. **DO NOT** overtighten and bend or shear the lockwasher inner tang.
- c. Loosen both locknuts one complete turn.

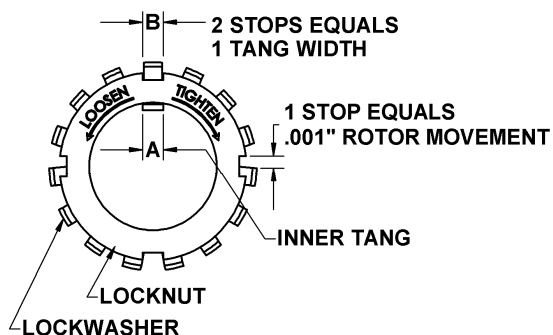
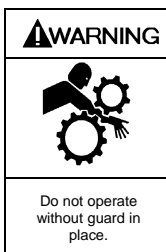

Figure 12 – Locknut Assembly

- d. Tighten one locknut until a slight rotor drag is felt when turning the shaft by hand.

- e. Back off the nut the width of one lockwasher tang "B". Secure the nut by bending the closest aligned lockwasher tang into the slot in the locknut. The pump should turn freely when rotated by hand.
- f. Tighten the opposite locknut (24A) by hand until it is snug against the bearing (24). Then, using a spanner wrench, tighten the nut the width of one lockwasher tang. Tighten just past the desired tang, then back off the nut to align the tang with the locknut slot. Secure the nut by bending the aligned lockwasher tang into the slot in the locknut. The pump should continue to turn freely when rotated by hand.
- g. To check adjustment, grasp the nut and washer with fingers and rotate back and forth. If this cannot be done, one or both locknuts are too tight and should be alternately loosened one stop at a time (.001" – 25 microns). Begin by loosening the locknut adjusted last.

16. Inspect the grease seal (104) for wear or damage and replace as required. Grease the outside diameter of the grease seal and push it into the inboard bearing cover (27) with the lip of the seal inward.
17. Attach a new bearing cover gasket (26) and the bearing cover (27) to the inboard head (20). Make sure the grease fittings (76) are accessible. Install and torque the bearing cover capscrews (28) to 30 lbs ft (40.7 Nm).
18. Install the grease seal (104) and bearing cover (27) on the opposite side of the pump per steps 16 and 17.
19. On 2-inch pump models, push the dirt shield (123A) over the inboard and outboard shafts and firmly against the bearing cover (27).
20. Attach the shaft protector (186) to the non-driven shaft end.



Operation without guards in place can cause serious personal injury, major property damage, or death.

21. Reinstall coupling, shaft key, and coupling guards.
22. Refer to "Pre-Start Up Check List" and "Start Up Procedures" sections of this manual prior to restarting pump operation.

FLANGE MOUNTED GEAR REDUCER MAINTENANCE

NOTICE:

Detailed maintenance instructions for the gearbox can be found at www.nord.com/docs. The following are excerpts from those documents and should be treated as reference only.

STORAGE

NOTICE:

For storage periods longer than 9 months, or for storage in less than desirable conditions, please consult NORD for recommendations.

Storage for up to 9 months is possible, so long as the following conditions are observed:

Store the gear unit in its actual mounting position in accordance with the specified oil fill-level, in a clean and dry temperature controlled area. Avoid temperature fluctuations within the range of 0°C and 40°C (32°F to 104°F) and avoid relative humidity conditions in excess of 60%.

Protect all exposed or unpainted shaft and flange surfaces with an anti-corrosion agent or grease.

Store in a location free from shock and vibration, to avoid false brinelling of bearing elements and raceways.

Whenever possible, rotate the shafts periodically, by hand if necessary, to help prevent brinelling (bearing damage) and to help keep the shaft seals pliable.

Avoid direct exposure to the sun or UV light and aggressive or corrosive materials in the environment (ozone, gases, solvents, acids, caustic solutions, salts, radioactivity, etc).

Commissioning

Prior to gear unit start-up, complete the following:

Please check your gear unit for a vent and if applicable to your product, remove the sealing plug to activate

NOTICE:

To prevent build-up of excessive pressure, sealed vents must be activated as shown prior to gear unit start up. Excessive pressure may cause damage to internal gearbox components and leakage.

- Check the lubricant and be sure the gear unit is filled with the proper oil type, to the proper level, as determined by the mounting position.
- Check the condition of all shaft seals and all assembled flange gasket areas. If any change is detected in the shape, color, hardness or permeability, or if any leaks are detected, the corresponding shaft seals and/or gaskets must be replaced.

- Remove all anti-corrosive metal protectant from otherwise bare metal surfaces. Follow product manufacturer's directions and warnings during surface protection removal.
- Check the resistance of all motor and brake windings to verify the integrity of the winding insulation and inspect all terminal box openings and wire connection areas to verify that all components are dry and free of corrosion.

Long Term Storage

By taking special precautions, problems such as seal leakage and reducer failure due to the lack of lubrication, improper lubrication quantity, or contamination can be avoided. The following precautions will protect gear reducers during periods of extended storage:

- Store the gear unit in its actual mounting position in accordance with the specified oil fill-level, in a clean and dry temperature controlled area. Avoid temperature fluctuations within the range of 0°C and 40°C (32°F to 104°F) and avoid relative humidity conditions in excess of 60%.
- Fill the reducer full with oil that is compatible with the product normally used or recommended during service.
- Apply grease to all unpainted or unprotected shafts, bores, keyways, flange surfaces, tapped holes, and to the exterior of all oil seals.
- Store in a location free from shock and vibration, to avoid false brinelling of bearing elements and raceways.
- Once every few months rotate the input shaft approximately 10-20 revolutions to redistribute the weight of gears and shafts and to prevent brinelling of the bearings and drying of the seal track.
- Avoid direct exposure to the sun or UV light and aggressive or corrosive materials in the environment (ozone, gases, solvents, acids, caustic solutions, salts, radioactivity, etc.)

Commissioning After Long-Term Storage

- Please check your gear unit for a vent and if applicable to your product, remove the sealing plug to activate.

NOTICE:

To prevent build-up of excessive pressure, sealed vents must be activated as shown prior to gear unit start up. Excessive pressure may cause damage to internal gearbox components and leakage.

- Remove all anti-corrosive metal protectant from otherwise bare metal surfaces. Follow product manufacturer's directions and warnings during surface protection removal.
- Drain the reducer and refill it with the proper type and amount of lubricant.
- Observe start-up and initial operation to make sure there are no seal or gasket leaks, or unusual sounds, vibration or heat rise during operation.
- Check the resistance of all motor and brake windings to verify the integrity of the winding insulation and inspect all terminal box openings and wire connection areas to verify that all components are dry and free of corrosion.

Lubrication

Proper gearbox lubrication is essential in order to reduce friction, heat, and component wear. Lubricants reduce heat and wear by inserting a protective “fluid boundary” between mating parts and preventing direct metal to metal contact. Lubricants also help prevent corrosion and oxidation, minimize foam, improve heat transfer, optimize reducer efficiency, absorb shock loads and reduce noise. Most NORD reducers are shipped from the factory with a pre-determined oil fill level in accordance to the specified reducer size and mounting position.

The standard orientation for the gearbox is shown in Figure 9. The gearbox is filled with the correct amount of oil and is the correct configuration for this orientation. For any other orientation, please consult the factory.

Lubrication Table

ISO Viscosity	Oil Type	Ambient Temp Range (°F)	Brand
VG220	PAO	-31 to 140	Mobil SHC630*
VG220	MIN-EP	32 to 104	Mobilgear 600XP220
VG220	FG	23 to 104	Fuchs FM220
VG460	PAO	-31 to 176	Mobil SHC 634

*Standard Oil Shipped with Gearbox

Oil Formulation Codes:

MIN-EP - Mineral Oil with EP Additive

PAO - Synthetic Polyalphaolefin Oil

FG - Food-Grade Oil

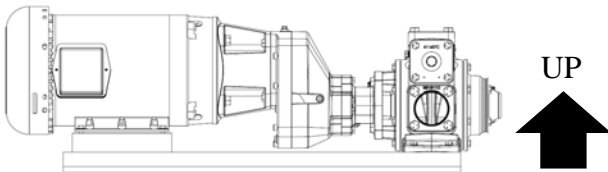

Figure 9 – Standard Gear Reducer Orientation

NOTICE:

The “Ambient Temperature” is intended to be an operation guideline based upon the typical properties of all the lubricant. The viscosity and other properties of the lubricant change based upon load, speed, ambient conditions, and reducer operating temperatures. The user should consult with their lubrication supplier & NORD gear before considering changes in oil type or viscosity.

- To prevent reducer overheating, observe the maximum operating oil temperature limits:
Mineral Oil: 176 – 180 °F
Synthetic Oil: 225 °F
- In the following instances, please consult NORD for specific recommendations:
 - Gear units will operate in high ambient temperature conditions exceeding 40 oC (104 oF).
 - Gear units will operate in cold ambient temperature conditions approaching 0 oC (32 oF) or lower.
 - Lower than an ISO VG100 viscosity oil is being considered for a cold-temperature service.
 - Fluid grease is required for lubricating the gear unit.
- Observe the general lubrication guidelines outlined in user manual U10750.

NOTICE:

Do not to mix different oils with different additive packages or different base oil formulation types. Polyglycol (PG) oils are not miscible with other oil types and should never be mixed with mineral oil or polyalphaolefin (PAO) synthetic oil.

TROUBLESHOOTING

NOTICE:

**Maintenance shall be performed by qualified technicians only,
following the appropriate procedures and warnings as presented in this manual.**

SYMPTOM	PROBABLE CAUSE
Pump Not Priming	<ol style="list-style-type: none">1. Pump not wetted.2. Worn vanes.3. Internal control valve closed.4. Strainer clogged.5. Inlet line or valves clogged or too restrictive.6. Broken drive train (truck mounted pumps).7. Pump vapor-locked.8. Pump speed too low for priming.9. Relief valve partially open, worn or not seating properly.
Reduced Capacity	<ol style="list-style-type: none">1. Pump speed too low.2. Internal control valve not fully open.3. Excessive restriction in the inlet line (i.e.: undersized piping, too many elbows & fittings, clogged strainer, etc.).4. Damaged or worn parts (vanes, discs, liner or rotor).5. Excessive restriction in discharge line causing partial flow through the relief valve.6. Relief Valve worn, set too low, or not seating properly.7. External Bypass Valve set too low.8. Operating without a vapor return line.9. Vanes installed incorrectly (see "Vane Replacement"). <p>Liner installed backwards</p>
Noise	<ol style="list-style-type: none">1. Excessive pressure drop on the pump due to:<ol style="list-style-type: none">a. Undersized or restricted fittings in the inlet line.b. Pump speed too fast.c. Pump too far from fluid source.2. Running the pump for extended periods with a closed discharge line.3. Pump not securely mounted.4. Improper drive line - truck mounted pumps (see "Pump Drive").5. Misalignment of pump, reducer or motor - base mounted pumps.6. Bearings worn or damaged.7. Vibration from improperly anchored piping.8. Bent shaft, or drive coupling misaligned.9. Excessively worn rotor.10. Malfunctioning valve in the system.11. Relief valve setting too low.12. Liner installed backwards.10. Damaged vanes (see following category).
Damaged Vanes	<ol style="list-style-type: none">1. Foreign objects entering the pump.2. Running the pump dry for extended periods of time.3. Cavitation.4. Excessive heat.5. Worn or bent push rods, or worn push rod holes.6. Hydraulic hammer - pressure spikes.7. Vanes installed incorrectly (see "Vane Replacement").13. Incompatibility with the liquids pumped.
Broken Shaft	<ol style="list-style-type: none">1. Foreign objects entering the pump.2. Relief valve not opening.3. Hydraulic hammer - pressure spikes.4. Pump/driver, driveline/drive shaft misalignment.8. Excessively worn vanes or vane slots.
Mechanical Seal Leakage	<ol style="list-style-type: none">1. O-rings not compatible with the liquids pumped.2. O-rings nicked, cut or twisted.3. Shaft at seal area damaged, worn or dirty.4. Ball bearings overgreased.5. Excessive cavitation.5. Mechanical seal faces cracked, scratched, pitted or dirty. <hr/> <ol style="list-style-type: none">6. <hr/>

Blackmer[®]

1809 Century Avenue, Grand Rapids, Michigan 49503-1530 U.S.A.
Telephone: (616) 241-1611 • Fax: (616) 241-3752