

BLACKMER HD COMPRESSORS

Installation, Operation, and Maintenance Instructions

960476

INSTRUCTIONS 901-B00

Section	901
Effective	May 2023
Replaces	Jun 2022

Single-Stage, Non-Lube, Reciprocating Gas Compressors

Air-Cooled Models

HD161C	HD162C	HD163C
HD361C	HD362C	HD363C

Water-Cooled Models

HDL322C	HDL323C
HDL342C	HDL343C
HDL362C	HDL363C

Discontinued Models

HD161B	HD162B	HD163B
HD361B	HD362B	HD363B

Table of Contents

Safety Data	2	Operation	
General Information		Pre-Start Up Check List	11
Compressor Data	3	Start Up Procedure	11
Nameplate Data	3	Maintenance	
Installation		Service Schedule	12
Location and Piping	5	Tool List	13
Mounting the Compressor Unit	5	Bolt Torque Table	13
Stationary Compressors	5	Crankcase Lubrication	14
Truck Mounted Compressors	5	Setting The Oil Pressure	14
Compressor Flywheel	6	Compressor Disassembly	15
V-Belt Drives	6	Compressor Assembly	16
PTO Drives	6	Valve Replacement	18
Suction Valve Unloaders	7	Unloader Seal Replacement	19
Water Cooled Compressors	7	Piston Ring Replacement	19
Maximizing Compressor Life	7	Seal (Packing) Replacement	20
Seal (Packing) Arrangements	8	Bearing Replacement	21
Relief Valves	9	Oil Pump Replacement	22
4-Way Valves	10	Extended Storage	22
Liquid Traps	10	Troubleshooting	23
Temperature and Pressure Switches	10		
Pressure Gauges	10		

SAFETY DATA



This is a SAFETY ALERT SYMBOL.

When you see this symbol on the product, or in the manual, look for one of the following signal words and be alert to the potential for personal injury or property damage.



Warns of hazards that **WILL** cause serious personal injury, death or major property damage.



Warns of hazards that **CAN** cause serious personal injury, death or major property damage.



Warns of hazards that **CAN** cause personal injury, or property damage.

NOTICE

Indicates special instructions which are very important and must be followed.

NOTICE

Blackmer compressors **MUST** only be installed in systems which have been designed by qualified engineering personnel. The system **MUST** conform to all applicable local and national regulations and safety standards.

These instructions are intended to assist in the installation and operation of Blackmer compressors and **MUST** be kept with the compressor.

Blackmer compressor service and maintenance shall be performed by qualified technicians **ONLY**. Service and maintenance shall conform to all applicable local and national regulations and safety standards.

Thoroughly review this manual, all instructions and hazard warnings, **BEFORE** performing any work on the compressor.

Maintain **ALL** system and compressor operation and hazard warning decals.

For handling liquefied petroleum gas, NFPA Pamphlet 58 should be consulted.



Flammable gas and/or liquid can form explosive mixtures with air causing property damage, serious personal injury or death

Flammable gas can cause death, serious personal injury or property damage



Failure to disconnect and lockout electrical power or engine drive before attempting maintenance can cause severe personal injury or death

Hazardous machinery can cause serious personal injury.



If handling hazardous or toxic fluids, system must be flushed and decontaminated, inside and out, prior to performing service or maintenance

Hazardous or toxic fluids can cause serious injury.



Explosive gas can cause property damage, personal injury, or death.

Hazardous gases can cause property damage, personal injury or death



Failure to relieve system pressure prior to performing compressor service or maintenance can cause serious personal injury or property damage.

Hazardous pressure can cause serious personal injury or property damage



Failure to disconnect and lockout electrical power before attempting maintenance can cause shock, burns or death

Hazardous voltage. Can shock, burn or cause death.



Disconnecting fluid or pressure containment components during compressor operation can cause serious personal injury, death or major property damage

Hazardous pressure can cause serious personal injury or property damage



Extreme heat can cause personal injury or property damage

Extreme Heat can cause personal injury or property damage

GENERAL INFORMATION

Table 1 - COMPRESSOR DATA	Air Cooled	
Single-Seal Models Double-Seal Models Triple-Seal Models	HD161C / HD161B HD162C / HD162B HD163C / HD163B	HD361C / HD361B HD362C / HD362B HD363C / HD363B
Displacement @ 350 rpm - CFM (m ³ /hr) @ 825 rpm - CFM (m ³ /hr)	7.16 (12.2) 16.9 (28.7)	15.3 (26.0) 36.0 (61.2)
Max. BHP (kw)	10 (7.5)	15 (11)
MAWP - psia (Bar)	350 (24.1)	
Maximum Discharge Temperature	350°F (176°C)	
Rotation Direction	Bi-Directional	

NOTE: Reduce maximum speeds by 9% for continuous duty operation.

	Water Cooled		
Double-Seal Models Triple-Seal Models	HDL322C HDL323C	HDL342C HDL343C	HDL362C HDL363C
Displacement @ 350 rpm - CFM (m ³ /hr) @ 825 rpm - CFM (m ³ /hr)	3.81 (6.47) 9.00 (15.3)	6.89 (11.7) 16.25 (27.6)	15.3 (26.0) 36.0 (61.2)
Max. BHP (kw)	15 (11)	15 (11)	15 (11)
MAWP - psia (Bar)	1000 (68.9)	750 (51.7)	350 (24.1)
Maximum Discharge Temperature	350°F (176°C)		
Rotation Direction	Bi-Directional		

NOTE: Reduce maximum speeds by 9% for continuous duty operation.

Critical Dimensions: Refer to Document CB241.

The models listed above are single-stage, vertical, air-cooled or water-cooled reciprocating style compressors with single acting cylinders. Single, double or triple seal arrangements are available.

The 'C' suffix models listed have a needle bearing on the wrist pin and include an external oil filter as standard. The 'B' suffix models listed have a bronze bushing on the wrist pin; the external oil filter is an available option.

MODEL: HD _____ ID#: _____ SERIAL NO: _____

Before proceeding:

1. Note the nameplate data in the space provided above.
2. Obtain the appropriate parts lists for the model in question.
3. These compressors are used on a wide variety of gasses. **Before doing any work on the compressor, be certain of the identification of the gas and the precautions to be followed when around that gas.**

Manuals and Parts Lists for Blackmer products may be obtained from Blackmer's website (www.blackmer.com) or be contacting Blackmer's Customer Service.

NAMEPLATE DATA

A nameplate is attached to the side of all Blackmer compressors showing the Model No., I.D. No., and Serial No. These numbers should be available when information or parts are needed for a particular unit.

The basic size and type of the compressor is indicated by "Model No." A suffix letter is used to indicate the version.

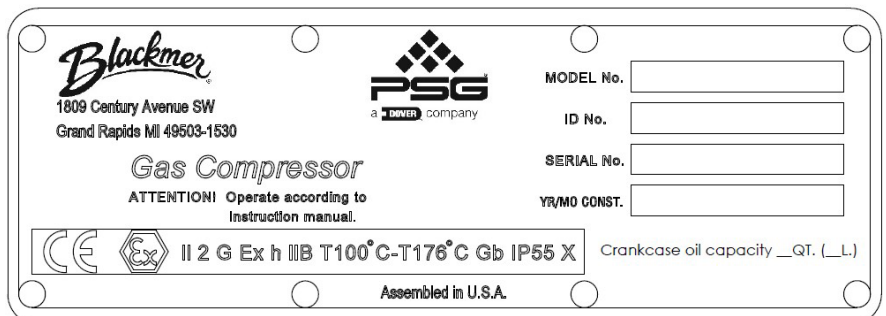

Figure 1 – Compressor Nameplate

For detailed ATEX Declaration information, refer to FORM 576 found in the Certification section of Blackmer's website.

GENERAL INFORMATION

Table 2 - Year of Manufacture *

Serial Number: 6 digits and a suffix letter indicating the year of manufacture.

Suffix	N	P	Q	R	S	T	U	V	W	X	Y	Z
Year	1993	1994	1995	1996	1997	1998	1999	2000	2001	2002	2003	2004

* Starting in 2005, the suffix letter is no longer used; the year & month of construction is indicated on the nameplate.

An 11 character "I.D. No." identifies the construction of the compressor.

Table 3 - ID NUMBER KEY

HD SINGLE-STAGE COMPRESSORS

P
B
B
F
M
1
T
A
1
A
0

VALVES	Code
TNT-12 steel	BE
TNT-12 steel w/ Unloaders	BF
Ductile Iron / PEEK	PB
DI/PEEK w/ Unloaders	PC
TNT-12 DI/PEEK	PE
TNT-12 DI/PEEK w/ Unloaders	PF
Stainless Steel	SB
SS w/ Unloaders	SC
O-RINGS	
Buna-N	B
Neoprene	N
PTFE	T
Fluorocarbon (FKM)	V
Ethylene-Propylene	E
GASKETS	
Aluminum	A
Iron	F
Copper	C
PISTON RINGS	
Glass & Moly Filled	M
Poly Filled PTFE	A
SEAL (PACKING) ORIENTATION	
All Lips up	1
Top Lips Down, Bottom Up Tube to Stage 1 outlet	2
Top Lips Up, Bottom Down	3
Up, Down, Up	5
Down, Down, Up	6
Down, Up, Down	7
Up, Up, Down – Vented	8
Down, Up, Down – Vented	9
SEAL MATERIAL	
PTFE	T
CYLINDER & HEAD	
Ductile Iron	A
TNT-12 DI Cylinder	B
TNT-12 DI Cyl. & Head	C
PISTON RODS	
Chrome Plated Steel	1
CrO ₂ Coated Steel	3
Black Surface Steel	4
CRANKSHAFT & OIL FILTER	
Standard	A
Extended Crankshaft	B
Spin-on Oil Filter	C
Ext. Crank & Oil Filter	D
FLYWHEEL *	
Standard Flywheel	0
No Flywheel	N

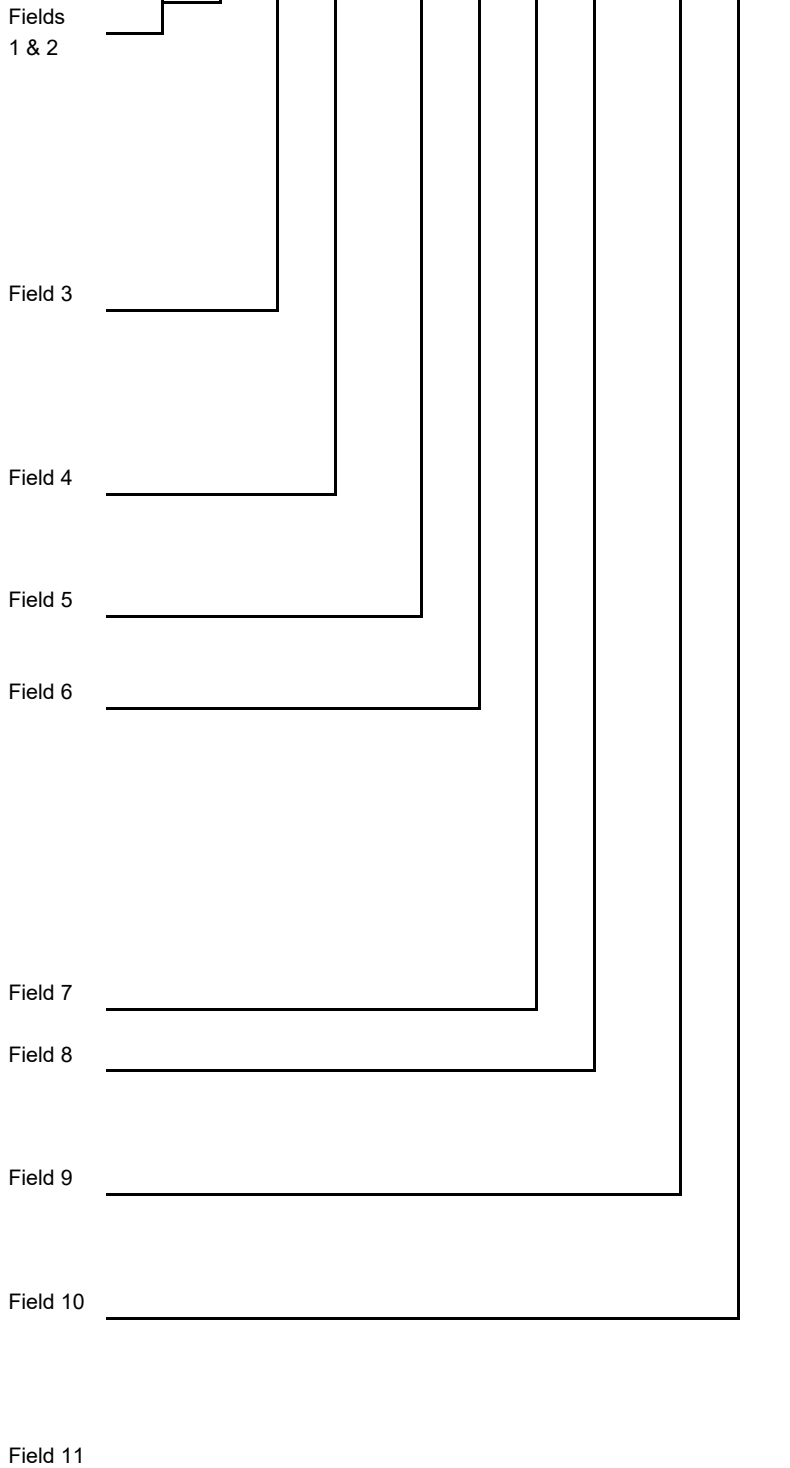

* Models Configured prior to 11/01/2017 used an "A" in this position to indicate standard selections.

Notes: A 'Z' in any field indicates a non-standard option. No model is available with all shown options.

INSTALLATION

NOTICE:

Blackmer compressors must only be installed in systems designed by qualified engineering personnel. System design must conform with all applicable regulations and codes and provide warning of all system hazards.

NOTICE:

This compressor shall be installed in accordance with the requirements of NFPA 58 and all applicable local, state and national regulations.

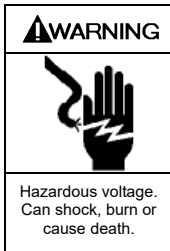

- ▲ Install, ground and wire to local and National Electrical Code requirements.
- ▲ Install an all-leg disconnect switch near the unit motor.
- ▲ Disconnect and lockout electrical power before installation or service

- ▲ Electrical supply **MUST** match motor nameplate specifications.
- ▲ Motors equipped with thermal protection automatically disconnect motor electrical circuit when overload exists. Motor can start unexpectedly and without warning.

LOCATION AND PIPING

Compressor life and performance can be significantly reduced when installed in an improperly designed system. Before starting layout and installation of the piping system, consider the following:

1. All piping must be leak free to a pressure of 1.5 times the maximum system pressure.

NOTICE: If the system is to be hydro-statically tested, the compressor **MUST** be isolated. Liquid entering the compressor will cause damage and void the warranty.

2. A strainer should be installed in the inlet line to protect the compressor from foreign matter. A #30 mesh screen or finer is recommended. Strainers **must** be cleaned every 180 days, or more frequently if the system requires.
3. Expansion joints, placed within 36" (0.9 m) of the compressor, will compensate for expansion and contraction of the pipes. Contact the flexible connector/hose manufacturer for required maintenance/care and design assistance in their use.
4. Piping **must** be adequately supported to ensure that no piping loads are placed upon the compressor.
5. Both suction and discharge piping should slope down from the compressor. The compressor should not be placed at a low point in the piping system.

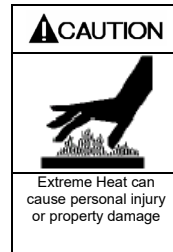

Discharge piping surface temperatures may be hot during operation (over 158°F, 70°F). Temperatures should be monitored and adequate warnings posted

MOUNTING THE COMPRESSOR UNIT

Stationary Compressors

A solid foundation reduces noise and vibration, and will improve compressor performance. On permanent installations, it is recommended the compressor be secured by anchor bolts as shown. This arrangement allows for slight shifting of position to accommodate alignment with the mounting holes in the base plate.

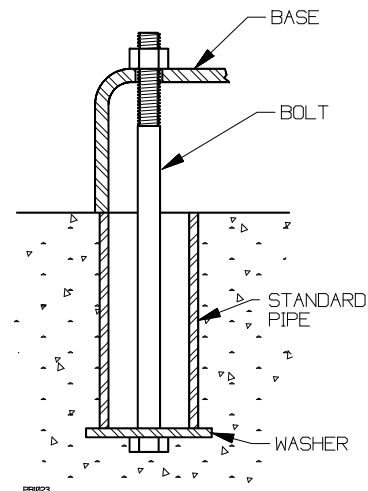

Figure 2 - Anchor Bolt

Set the anchor bolts in concrete for new foundations. When compressors are to be located on existing concrete floors, holes should be drilled into the concrete to hold the anchor bolts.

To keep vibration at a minimum, in addition to a solid concrete foundation, it is important that the concrete be located on a stable soil foundation. The base must have complete contact along its entire length with the foundation. Visible separations will result in vibrations which are magnified in the upper part of the unit.

Check compressor mounting bolts and baseplate anchor bolts regularly.

See CB220 "Compressor Bases, Skids and Foundations" for additional information.

Truck Mounted Compressors

Blackmer compressors may be mounted to the frame rails of a truck/transport and driven by either a V-belt or PTO drive.

The compressor should be solidly mounted and care should be taken to ensure that the dipstick and inspections plates are readily accessible.

INSTALLATION

COMPRESSOR FLYWHEEL

Blackmer compressors are fitted with flywheels which **MUST** be used regardless of the type of drive system employed.

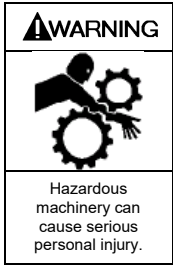

Failure to disconnect and lockout electrical power or engine drive before attempting maintenance can cause severe personal injury or death

Flywheels must be properly installed and aligned:

1. Ensure that the mating surface between the hub and flywheel are clean and dry – do not use a lubricant.
2. Install the hub and key on clean compressor shaft, flange end first.
3. Tighten the hub setscrew just enough to prevent it from sliding on the shaft – do not overtighten.
4. Place the flywheel on the hub and loosely thread the capscrews with lockwashers into the assembly. Do not use lubricant on the capscrews.
5. Tighten all capscrews evenly and progressively in rotation to the torque value in Table 4. There must be a gap between the hub flange and the flywheel with installation is complete. **Do not over-torque. Do not attempt to close gap between hub flange and flywheel.**

Hub Size	Capscrew Size	Torque ft-lbs. (Nm)
SF	3/8 – 16	30 (40.7)
E	1/2 - 13	60 (81)
F	9/16 – 12	75 (101)

Table 4 – Flywheel Hub Torque Values

6. Ensure that the radial and axial runout values at the rim do not exceed the following values:
Radial O.D. Runout: 0.016 in. (0.4046 mm)
Axial Rim Runout: 0.021 in. (0.5334 mm)
7. Ensure that the compressor flywheel guard is properly installed before operation. The guard must not contact moving parts.



Flywheel guard contact with moving parts may be a source of ignition in explosive atmospheres causing severe personal injury or death

V-BELT DRIVES

Most Blackmer compressors are driven via V-belts which must be properly aligned and tensioned.

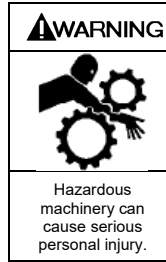

Failure to disconnect and lockout electrical power or engine drive before attempting maintenance can cause severe personal injury or death

1. Lay a straight edge along the face of the motor sheave and compressor flywheel.
2. Adjust either as needed to provide alignment.
3. Tighten the V-belts such that they are taut, but not overly tight. Moderate thumb pressure should deflect each belt about 1/4 – 3/8 in. (6 – 10 mm). Consult your V-belt supplier for specific values.
4. Check the belt tension after 24 - 48 hours run-in. Recheck periodically; tighten the belts as required.

Caution should be used to avoid overtightening belts, which can shorten bearing and belt life. Belts should be inspected periodically for signs of excessive wear and replaced if necessary.

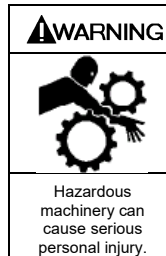

Operation without guards in place can cause serious personal injury, major property damage or death.

PTO DRIVES

Truck mounted compressors may be driven by the power take-off through a jackshaft connected by universal joints. The compressor must be fitted with an optional extended crankshaft to use a PTO drive without removing the flywheel. Proper PTO installation is essential:

1. Compressor shaft and PTO shaft must be parallel.
2. The yokes at the end of the jackshaft must be parallel and in phase.
3. The angle between two shafts must not exceed 15°.
4. An EVEN number of U-joints must be used.
5. PTO shafts **MUST** have guards installed.

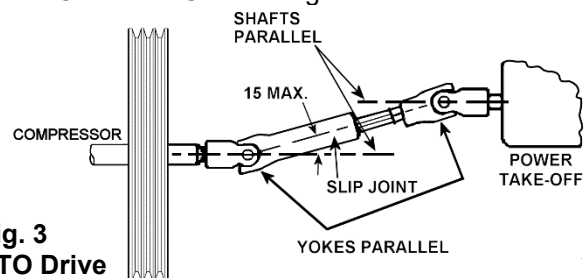

Fig. 3 PTO Drive

INSTALLATION

SUCTION VALVE UNLOADERS

Compressors may be fitted with suction valve unloaders to provide loadless start or capacity control functions. Blackmer unloaders are basically a piston and a plunger atop the suction valve. When pressure is applied to the top of the unloader piston, it and the plunger move downward, pushing the suction valve off its seat and unloading the compressor. When the pressure signal is removed, the unloader spring pushes the piston and plunger back up and the suction valve will resume normal operation.

1. In order for the unloaders to function, the unloader pressure must be at least 30 psi (2.1 Bar) above suction pressure.
2. Do not operate unloaders for longer than 10 minutes as gas recirculation through the suction valves will cause overheating.

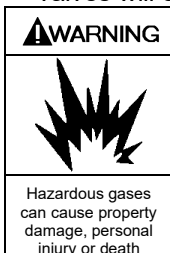

Excessive gas recirculation using suction valve unloaders can be a source of ignition in explosive atmospheres causing severe personal injury or death

3. Do not place a restrictive device such as a back check valve in the suction line near the compressor. If such a device must be installed, the volume in the piping between the device and the compressor must be at least 10 times the cylinder swept volume.

WATER-COOLED COMPRESSORS

NOTICE:

Do not operate water-cooled units without water flow!

Cooling water should be clean and at not more than 100 psig (6.90 Bar-g). A flow of 1 gpm (4 lpm) is normally adequate. In general, cooler water temperatures are preferable. However, care must be taken as condensation may occur inside the compressor if the water is too cold. Such condensation can cause corrosion or even destroy the compressor.

NORMAL WATER FLOW PATH:

→→→ cylinder →→→ head →→→

MAXIMIZING COMPRESSOR LIFE

Life of critical compressor components such as piston rings, valves and packing will vary considerably with each application, installation, and operating procedures. Premature failure of wear parts can often be attributed to one of the following causes:

1. Excessive Temperatures

Primary causes are:

- Operating at pressures other than those originally specified.
- Handling a different gas than originally specified.
- Clogged strainer or filter elements.
- Line sizes too small, or other flow restrictions.
- Excessive ambient temperature or suction gas temperature.
- Valve problems. (See Foreign Material.)
- Badly worn piston rings. (See Foreign Material.)

Lower operating temperatures will increase valve and piston ring life significantly.

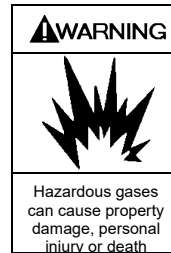

Extreme temperatures caused by abnormally high discharge pressure or valve problems can be a source of ignition in explosive atmospheres causing severe personal injury or death.

2. Foreign Material

Solid particles in the gas stream will:

- Rapidly wear the piston rings and score the cylinder wall.
- Destroy the rod packing causing excessive leakage and score the piston rods.
- Lodge in the valves causing loss of capacity and broken valve plates and springs.

Liquid in the gas stream will:

- Cause broken valve plates and springs.
- Destroy the compressor if present in sufficient quantity.

On new installations, it is suggested that the valves and piston rings be inspected after the first few hundred hours of operation. This will give an early indication of any abnormal problems and allow for corrective action to be taken before a costly failure results. Although piston ring life will vary from application to application, wear will be fairly consistent on subsequent sets of rings.

INSTALLATION

SEAL (PACKING) ARRANGEMENTS

Single, Double and Triple Seal models are available to provide a wide range of leakage control/containment options. Before starting work on the compressor, note the seal orientation indicated by the 6th digit of the Compressor ID # shown on the compressor's nameplate.

Also note any tubing connections in the seal area. 1/4" NPT ports are provided between each pair of seals to allow proper venting or pressurization of the seal areas (double and triple seal models only). For more information, see CB-037 "Compressor Distance Piece Options".

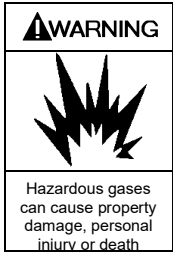

Improper seal installation could release explosive gas to the atmosphere creating an explosion hazard, possibly causing severe personal injury or death.

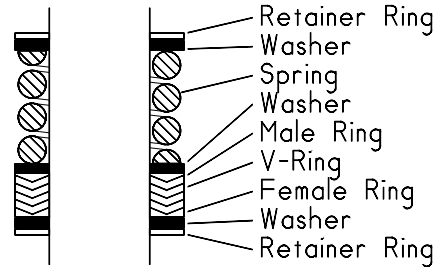

Fig. 4 - SEAL ORIENTATION - SINGLE SEAL COMPRESSORS

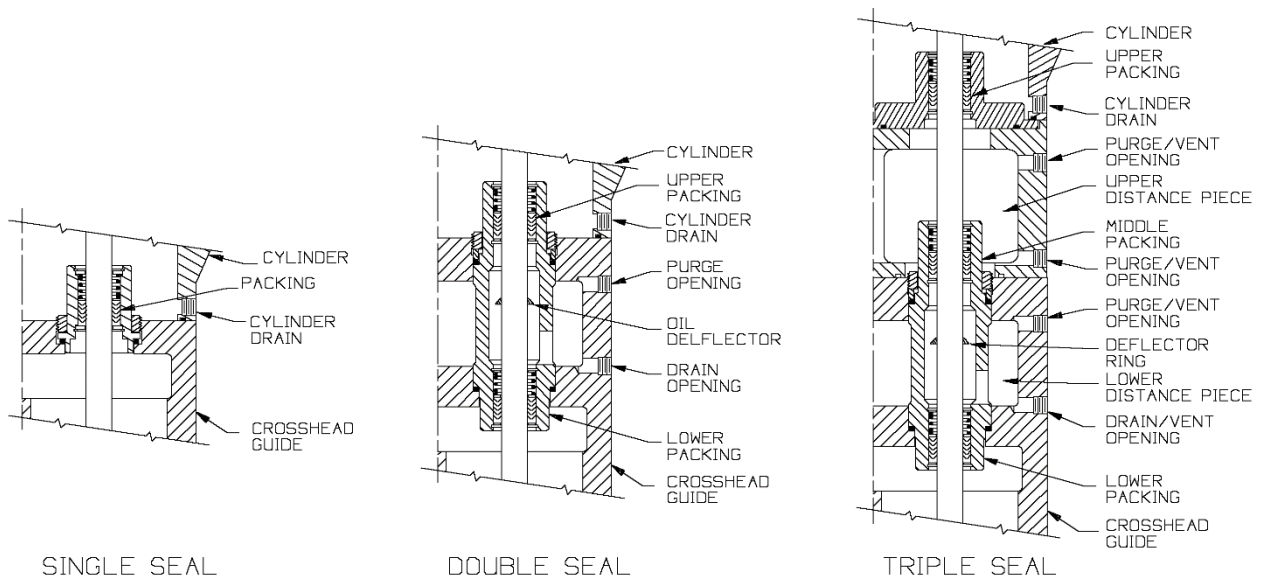

Fig. 5 - TYPICAL SEAL AREA CONSTRUCTION

Table 5 - SEAL ARRANGEMENTS - ALL DOUBLE SEAL COMPRESSORS

Type	1		2		3
Inlet Pressure	Atmospheric Pressure or above		Vacuum to 25 psia		
Service	General Gas Transfer	Toxic, Flammable or otherwise Hazardous Gases		General Gas Transfer	Special
Upper Distance Piece Connections	Plugged	Purge with Inert gas below suction pressure and above atmospheric pressure, or Vent to a safe location	Pressurize, or Purge with an Inert gas above suction pressure and above atmospheric pressure	Connect to: 1st-Stage Discharge	
Lower	Install drain valve. Drain accumulated condensate or oil weekly.				
Ref. Notes:	a	b		a	c

NOTES:

- a. Standard Configuration - use when no purge gas is available, or when mixing of the purge gas with the product stream is not desirable.
- b. Use when no external product leakage is desirable.
Note: Mixing of inert pressurization gas and the product stream is likely to occur.
- c. Consult Factory.

INSTALLATION

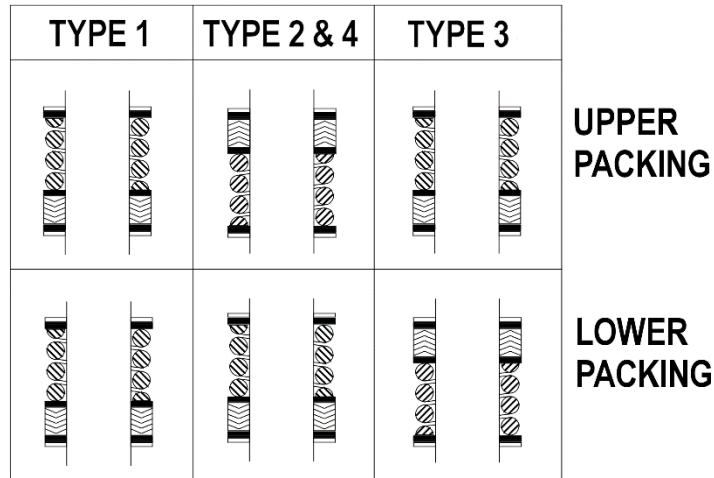

Fig. 6. Seal orientation -double seal models

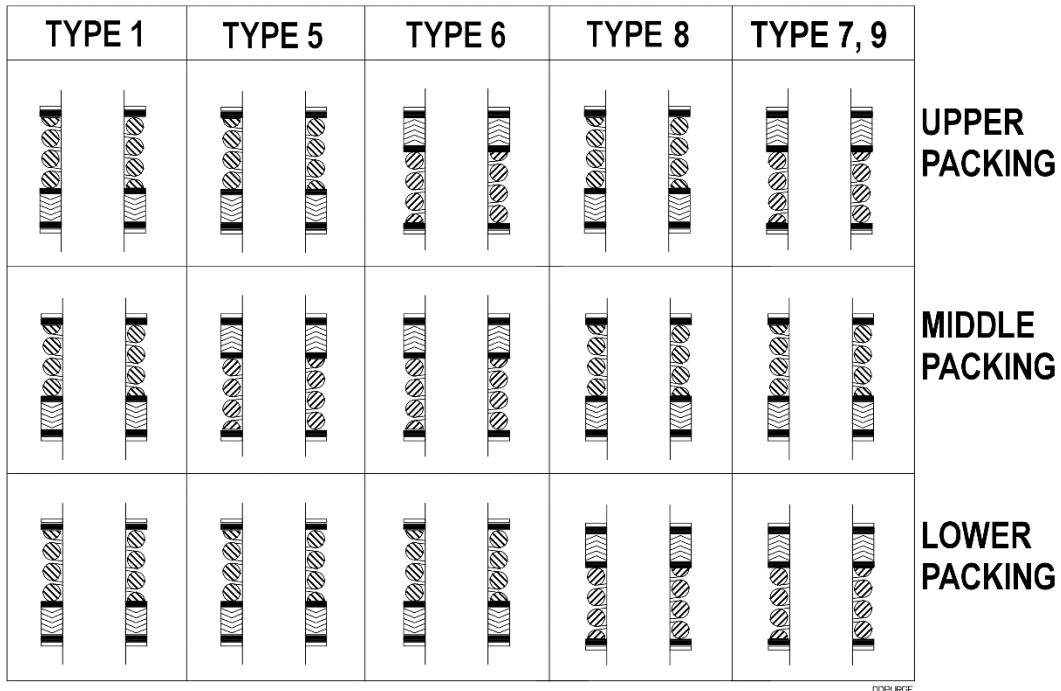
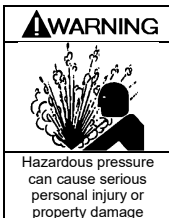

Fig. 7. Seal orientation -triple seal models

RELIEF VALVES

A relief valve of a type, material and pressure rating suitable to the installation, **MUST** be installed. The relief valve shall be installed in the discharge line between the compressor head and the first block valve.



Compressor operating against closed valve can cause system component failure, personal injury or property damage.

Since all systems differ in design, care must be taken to ensure the relief valve is installed to safely vent away from sources of ignition and personnel. This can be

accomplished by either orientation or a pipe away, consult the Relief Valve manufacture for assistance.

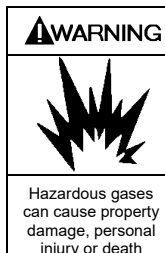

Operation of the relief valve can release explosive gas to the atmosphere creating an explosion hazard, possibly causing personal injury or death

Should the Relief Valve actuate, the cause **MUST** be determined and corrected before continuing operations. See the 'Troubleshooting' section.

Blackmer offers various relief valves for gas and application compatibility.

INSTALLATION

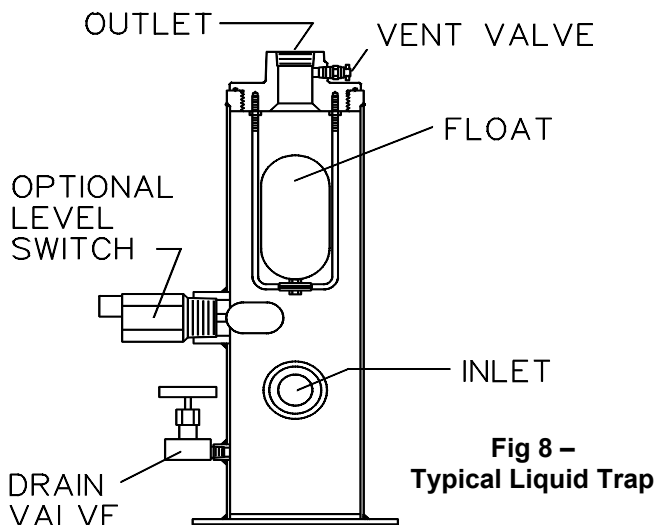

Fig 8 –
Typical Liquid Trap

790119

LIQUID TRAPS

Compressors handling gasses containing condensates or other liquids **MUST** be protected from entry of the liquid. Liquid can also enter the compressor from the discharge piping, particularly if the piping slopes down toward the compressor. To prevent liquid from entering the compressor and causing major damage, it is necessary to carefully consider the system design and have strict procedures for operation.

NOTICE: Liquid in the compressor cylinder can cause destruction of the compressor.

Blackmer offers a variety of liquid traps. The most common variations include:

1. A non-code vessel fitted with a stainless steel float which will shut off the intake line to the compressor in the event of an excessive liquid level. A vacuum breaking valve is provided on the liquid trap head in case the trap closes and a vacuum develops between the compressor and the trap. A manual drain valve is provided.
2. The above trap is fitted with a port allowing for the use of an electric float switch which protects the compressor by stopping the compressor when a high liquid level is present in the liquid trap. The electric float switch may be used with or without the mechanical float described above.
3. For additional protection, a larger ASME code stamped vessel is available. This liquid trap is typically fitted with one or two electric float switches for both a high liquid level shut down and alarm signal, a relief valve, and a manual drain valve. This type trap is needed if level gauges or automatic drain systems are to be used.

4-WAY VALVES

Many liquefied gas compressors are used for both liquid transfer and vapor recovery operations. An optional 4-way valve is used to reverse the direction of flow through the system when changing from liquid transfer to vapor recovery. Both lubricated and nonlubricated models are available. Lubricated models should be lubricated every 6 months.

TEMPERATURE SWITCHES

Excessive discharge temperature is a leading cause of premature component failure and is often an early warning sign of impending problems.

Optional temperature switches should be installed with a thermowell as close to the compressor discharge as possible. The switch should be set to actuate at a temperature just above the maximum operating temperature of the compressor.

ATEX compliant compressors **must** have a temperature switch installed.

LOW OIL PRESSURE SWITCHES

Loss of crankcase oil pressure is a rare occurrence, but can result in costly damage. An optional low oil pressure switch set at about 15 psig (1 bar-g) may be installed to shut down the compressor in the event of a lubrication failure. A 10 second delay timer should be used to lock the low oil pressure switch out during compressor startup.

PRESSURE SWITCHES

Pressure switches may be installed in the suction or discharge gas stream as protective devices, for compressor control, or for other uses varying with each application and system design.

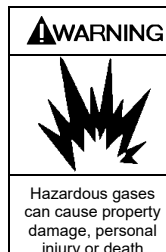

Optional liquid trap level switches, temperature switches, pressure switches or other electrical devices must be properly specified for applications using explosive gases.

PRESSURE GAUGES

Install pressure gauges in the discharge and inlet lines to verify actual suction and discharge pressures.

OPERATION

PRE-STARTUP CHECK LIST

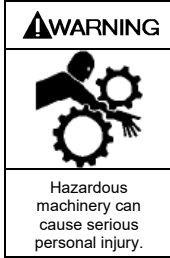

Failure to disconnect and lockout electrical power or engine drive before attempting maintenance can cause severe personal injury or death

1. After the compressor is installed in the system, a complete leak test **MUST** be performed on both the compressor and the piping.

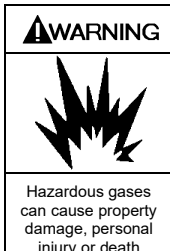

Failure to properly leak test the compressor installation may result in leakage of explosive gas to the atmosphere creating an explosion hazard, possibly causing severe personal injury or death.

2. Re-check the system piping and the piping supports to ensure that no piping loads are being placed on the compressor.



Discharge piping surface temperatures may be hot during operation (over 158°F, 70°C). Temperatures should be monitored and adequate warnings posted.

3. If V-belt driven, check the alignment of the motor and the compressor sheaves. The faces of the sheaves must be parallel.
4. Ensure that pressure gauges are installed on both inlet and discharge of the compressor.
5. Blackmer compressors are shipped from the factory without oil in the crankcase. Fill with a high quality non-detergent oil of the proper viscosity via the compressor nameplate opening. See "Crankcase Lubrication" in this manual.
6. Check the electrical connections for proper wiring, grounding, etc.
7. With the power disconnected, remove the compressor nameplate. Squirt oil onto each crosshead while rotating the compressor by hand to verify smooth operation.
8. Ensure that all guarding is properly installed.

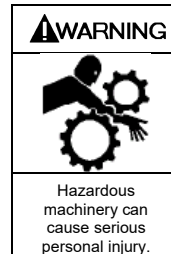

Operation without guards in place can cause serious personal injury, major property damage or death.

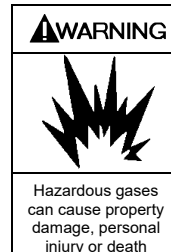

Flywheel guard contact with moving parts may be a source of ignition in explosive atmospheres causing severe personal injury or death

STARTUP PROCEDURE

NOTICE:

Consult the 'troubleshooting' section of this manual if difficulties during startup are experienced.

1. Start the compressor. Oil pressure should register 25 psig (1.7 bar-g) within 10 seconds.

If proper oil pressure is not present, stop the compressor and correct the problem.

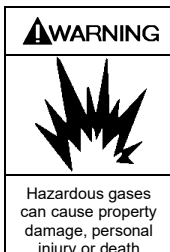

Operation of the compressor with low or no oil may result in extreme temperature in the crankcase. This could be an ignition source in the presence of explosive gas and could lead to severe personal injury or death.

Operating the compressor with low oil pressure will cause severe damage to the unit. See "Setting the Oil Pressure" in this manual.

The oil pump on these models will operate in either direction of crankshaft rotation.

2. Verify that the suction and discharge pressures are within the expected ranges.

Operating limits listed in the "Compressor Data" section must not be exceeded.

3. Check for leakage from the piping and equipment, and repair as necessary.
4. If the seals (packing) have just been replaced or if the compressor has been out of service for over 6 months, the lower seal **MUST** be manually lubricated during the first 60 minutes of operation. See "Seal (Packing) Replacement" section. New compressors have had the packing broken in at the factory.
5. On newly rebuilt units, the valve hold down screws, valve cover plate bolts and cylinder head bolts **MUST** have their torque checked after 60 minutes running time. Also re-tighten all hold down bolts, flywheel bolts, etc. after 60 minutes running time. See the "Bolt Torque." table.

MAINTENANCE

⚠ DANGER



Flammable gas can cause death, serious personal injury or property damage

Flammable gas and/or liquid can form explosive mixtures with air causing property damage, serious personal injury or death

⚠ WARNING



Hazardous pressure can cause serious personal injury or property damage

Failure to relieve system pressure prior to performing compressor service or maintenance can cause serious personal injury or property damage.

⚠ WARNING



Hazardous machinery can cause serious personal injury.

Failure to disconnect and lockout electrical power or engine drive before attempting maintenance can cause severe personal injury or death

⚠ WARNING



Hazardous voltage. Can shock, burn or cause death.

Failure to disconnect and lockout electrical power before attempting maintenance can cause shock, burns or death

⚠ WARNING



Hazardous or toxic fluids can cause serious injury.

If handling hazardous or toxic fluids, system must be flushed and decontaminated, inside and out, prior to performing service or maintenance

⚠ WARNING



Hazardous pressure can cause serious personal injury or property damage

Disconnecting fluid or pressure containment components during compressor operation can cause serious personal injury, death or major property damage

⚠ WARNING



Hazardous gases can cause property damage, personal injury or death

Explosive gas can cause property damage, personal injury, or death.

⚠ CAUTION



Extreme Heat can cause personal injury or property damage

Extreme heat can cause personal injury or property damage

NOTICE:

Blackmer compressor service and maintenance shall be performed by qualified technicians only. Service and maintenance shall conform to all applicable local and national regulations and safety standards.

SERVICE SCHEDULE

	Daily	Weekly	Monthly	6 Months	Yearly
Overall Visual Check	X				
Check Crankcase Oil Pressure	X				
Check Suction Pressure	X				
Check Discharge Pressure	X				
Drain Drainage Piece (Double & Triple-Seal Models)		X			
Drain Liquid From Accumulation Points		X			
Clean Compressor Cooling Fins		X			
Check Crankcase Oil Level *			X*		
Check Mounting and Anchor Bolts			X		
Check V-Belt Tension			X		
Change Oil and External Oil Filter *				X*	
Check Inlet Filter/Strainer Element				X	
Inspect Valves				X	
Lubricate 4-way Valve (if equipped)				X	
Lubricate Motor Bearings per Manufacturer's Suggestions				X	
Inspect Motor Starter Contact Points					X

* Change oil every 1,000 hours of operation, or every 6 months which ever occurs first. If the oil becomes dirty or diluted, change oil and external filter as often as needed to maintain clean oil.

Table 6 - Service Schedule

MAINTENANCE

Table 7 - TOOL LIST

Description	Used For:
Blackmer Packing Installation Tool (PN 790536)	Rod-packing protection during installation.
Blackmer Wrench 798016	Valve Hold-down Ring Torque Tool
Blackmer Torque Wrench Adaptors 798002 for HD160 Series Compressors 798004 for HD/HDL360 Series Compressors 798009 for HDL340 Series Compressors 798001 for HDL320 Series Compressors 798010 for all models listed	Piston Piston Piston Piston and Piston Nut Piston Nut
Blackmer Wrench 798015	Packing Box Hold-down Ring Torque Tool
3" Adjustable Spanner with 1/4" pins (like Blackmer PN 790316)	Piston Nut, Piston, Packing Box Hold-down Ring
9/16, 5/8 or 3/4" End Wrench	Cylinder and Crosshead Guide
1-1/16" Wrench or Socket	Valve Caps
3/16" Allen Wrench	Oil Pump Cover
7/16", 1/2", 9/16", 3/4", 5/8", 3/4", 7/8" & 1-3/8" Sockets	Various
Internal Snap Ring Pliers	Seal Replacement
Feeler gauges or Depth Micrometer	Piston Clearance
Screwdriver, Flat Blade	Nameplate screws, Packing Installation
Pliers	
Rubber Mallet	
Arbor Press	Wrist Pin Removal
Bearing Puller	Crankshaft Bearings
Torque Wrench	Various
Hoist (useful)	Cylinder and Crosshead Guide

BOLT TORQUES

Proper bolt torques to use when reassembling the compressor.

Table 8 - BOLT TORQUES FOR BLACKMER COMPRESSORS FT-LBS (Nm)

Sizes	Con. Rod Bolt	Bearing Carrier	Bearing Cover Plate	Crankcase Inspection Plate	Oil Pump Cover	Cross Head Guide	Packing Box Hold Down Ring	Cylinder
100	30 (40.7)	30 (40.7)	30 (40.7)	7 (9.5)	12 (16.3)	25 (33.9)	75 (102)	25 (33.9)
300	35 (47.5)	30 (40.7)	30 (40.7)	7 (9.5)	12 (16.3)	35 (47.5)	75 (102)	35 (47.5)

Sizes	Head	Piston & Nut	Valve Assy. Nut /Unloader Post	Unloader Retainer Bolt	Valve Cover Plate	Valve Hold Down Screw	Valve Cap
100	20 (27.1)	40 (54)	--	--	--	120 (163)	80 (108)
300	40 (54)	40 (54)	10 (13.6)	10 (1306)	35 (47.5)	120 (163)	80 (108)

MAINTENANCE

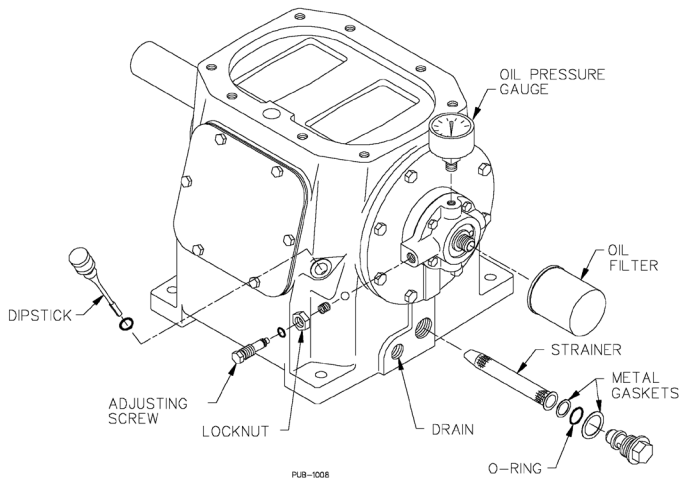

Figure 9 - Compressor Lubrication System

CRANKCASE LUBRICATION

Change the crankcase oil every 1,000 hours or 180 days, whichever is shorter. Under severe dusty, sandy or wet operating conditions, the oil should be changed every 500 hours or every 90 days.

If the crankcase oil becomes contaminated or diluted due to gas leakage past the packing seals, the oil must be changed more frequently. In such cases, change the packing seals as soon as possible.

Non-detergent oils are recommended. Detergent oils can be used providing the gas being handled does not react with the detergent in the oil. If using a detergent oil, be sure there is not a compatibility problem. Ammonia, amine and imine gases are known to react with many of the detergents in oil.

The oil used, detergent or non-detergent, should be of high quality such as API grade SJ, SL, SM, SN or similar.

API grade SA, SB, SC or similar oils should never be used. Recycled oils should never be used.

Synthetic oils are acceptable; use the same guidelines as mineral based lubricants. Consult factory for special lubricating requirements.

Before changing the oil, bring the compressor up to normal operating temperature. Remove the crankcase drain plug and drain the oil into an adequately sized container. Remove the oil pickup screen and clean in a suitable solvent. When reinstalling the pickup screen, inspect the metal gasket and the O-ring for damage, replacing as necessary. If equipped, replace the external oil filter. See Figure 9.

Refill the crankcase via the dipstick or nameplate opening. **DO NOT OVERFILL THE CRANKCASE!**

The oil pump on these models will operate in either direction of crankshaft rotation.

Size	Quarts	Liters
160	2	1.89
320 / 340 / 360	3	2.84

Table 9 - Oil Capacity

Mineral Based Oil - API Grade SN, SM, SL, SJ

ISO Grade	SAE	Ambient Temperature	Product
100	30	80°F (27°C) and above	Mobil® Rarus 427 or equivalent
46	20	32 to 80°F (0 to 27°C)	
32	10	0 to 32°F (-18 to 0°C)	
22 - 15	5 - 0	Below 0°F (-18°C)	

Synthetic Oil

ISO Grade	SAE	Ambient Temperature	Product
68	20+	Full Range	Mobil® SHC Rarus 68 or equivalent

Table 10 - Oil Viscosity

SETTING THE OIL PRESSURE (see Figure 9)

1. The oil pressure should be about 25 psig (1.73 Barg).
2. Loosen the locknut.
3. Increase the pressure setting by turning the adjusting screw inward, CLOCKWISE.
Decrease the pressure setting by turning the adjusting screw outward, COUNTER-CLOCKWISE.
4. Retighten the locknut.

COMPRESSOR DISASSEMBLY

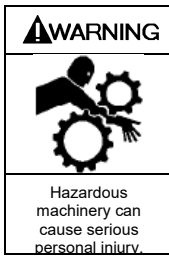

Failure to disconnect and lockout electrical power or engine drive before attempting maintenance can cause severe personal injury or death

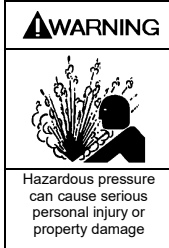

Failure to relieve system pressure prior to performing compressor service or maintenance can cause serious personal injury or property damage.

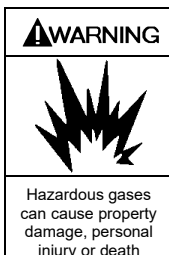

Venting pressure from the compressor piping could release explosive gas to the atmosphere creating an explosion hazard, possibly causing severe personal injury or death.

NOTICE:

Before starting work on the compressor, make sure all pressure is bled off on both the suction and discharge.

1. Remove the center head capscrews from the cylinder head. Remove the outer cylinder head capscrews.
2. The cylinder head assembly and cylinder head O-rings can now be removed from the cylinder. The suction and discharge valve assemblies will come off with the cylinder head. For valve disassembly instructions refer to "Valve Replacement."
3. Removal of the piston requires a 3" adjustable spanner wrench with 1/4" pins (such as Blackmer PN 790316)
 - a. Rotate the flywheel by hand to bring a piston to top dead center of the cylinder.
 - b. Remove the piston nut by rotating the nut counterclockwise. (The nylon locking insert in the piston nut must be replaced during reassembly.)
 - c. To remove the piston from the cylinder, rotate it counterclockwise with the use of the adjustable spanner wrench. For removal and replacement of the piston rings, refer to "Piston Ring Replacement."
 - d. Remove the thrust washer and shims. Keep the shims & piston together.
 - e. Repeat these steps for the other piston.
4. Remove the cylinder capscrews.
5. The cylinder and cylinder O-rings can then be lifted from the crosshead guide (or distance piece).
6. Removal of the packing boxes is dependent on the

Model Number of the Compressor. For disassembly of the packing boxes, refer to "Seal (Packing) Replacement".

Single-Seal Models

- a. Using an adjustable spanner wrench, remove the packing box hold-down rings. (Replace the nylon locking inserts in the hold-down rings during reassembly.)
- b. Remove the packing boxes and packing box O-rings from the piston rods.

Double-Seal Models

- a. Using an adjustable spanner wrench, remove the packing box hold-down rings. (Replace the nylon locking inserts in the hold-down rings during reassembly.)
- b. The spacer rings, upper packing box O-rings, packing boxes and lower packing box O-rings can then be removed from the piston rods.

Triple-Seal Models

- a. Lift the upper packing box assemblies and O-rings off the piston rods.
 - b. Remove the upper distance piece capscrews and lift the upper distance piece and O-rings off the crosshead guide.
 - c. Using an adjustable spanner wrench, remove the packing box hold-down rings. (Replace the nylon locking inserts in the hold-down rings during reassembly.)
 - d. The spacer rings, upper packing box O-rings, packing boxes and lower packing box O-rings can then be removed from the piston rods.
7. Remove the crosshead guide capscrews, then lift the crosshead guide and gasket off.
 8. To remove the connecting rod assemblies (with the crossheads attached) it may be necessary to drain the oil from the crankcase. **NOTE:** The piston rod is permanently attached to the crosshead to form a single assembly. Do not attempt disassembly.
 - a. Remove the crankcase inspection plate.
 - b. Remove the locknuts from the connecting rod bolts. This will release the connecting rod cap (the lower half of the connecting rod) and the two halves of the bearing insert. **NOTE:** The connecting rod and the connecting rod cap are marked with a dot on one side so that they can be matched properly when reassembling.
 - c. Lift the crosshead assembly and connecting rod off the crankcase. **NOTE: The connecting rod parts are not interchangeable and must be reassembled with the same upper and lower halves. To avoid confusion, work on one connecting rod at a time, or mark the individual halves with corresponding numbers.**

COMPRESSOR DISASSEMBLY

9. Remove the opposite connecting rod and crosshead assembly in the same manner.
10. Rest the crosshead assembly on a bench. Carefully drive the wrist pin and wrist pin plugs out of the crosshead and connecting rod using a suitable pin driver or an arbor press. Removal of the pin releases the crosshead assembly from the connecting rod.
11. If necessary, the wrist pin needle bearings or bushings can be replaced after the crossheads are removed.

Connecting Rods with new brass bushings (instead of needle bearings) **must** be honed to the proper size after installation. Inner Dimensions:

0.8753" to 0.8756" (22.233 mm to 22.240 mm).

12. To replace the crankshaft bearings, the crankcase must be disassembled, and the crankshaft removed. Refer to "Bearing Replacement" for disassembly instructions.

COMPRESSOR ASSEMBLY

Compressor assembly is generally the opposite of compressor disassembly. Before reassembling, clean each part thoroughly. Check all machined surfaces for burrs or roughness, and file lightly if necessary. **Replace any O-rings or gaskets that are removed or disturbed during service.**

1. CRANKCASE ASSEMBLY

After replacing the crankshaft, bearing carrier, and bearing cover plate (see "Bearing Replacement"), the connecting rod and crosshead can be installed.

- a. To attach the connecting rod to the crosshead assembly, first coat the wrist pin, the wrist pin bore in the crosshead assembly, and the wrist pin bearing in the connecting rod with grease.
- b. Start the wrist pin in the bore of the crosshead assembly until the pin begins to project through to the inside of the crosshead assembly. (Use an arbor press if available.)
- c. Slide the connecting rod up inside of the crosshead assembly and align the bearing with the wrist pin.
- d. Install the wrist pin through the connecting rod until it is centered in the crosshead assembly. NOTE: The wrist pin should be snug in the crosshead assembly. The connecting rod should rotate freely on the wrist pin, but should not be loose.
- e. Dip the wrist pin plugs in grease and press them in place.
- f. Place the bearing halves into each half of the connecting rod, aligning the bearing tangs with the slots in the connecting rod. Coat the bearing with grease.
- g. Set the top of the connecting rod over the crankshaft journal. Replace the connecting rod cap, remembering that the dots on the connecting rod and cap must be on the same side.
- h. Start the nuts on the connecting rod bolts and torque per the Bolt Torque Table.
- i. Follow this same procedure for the opposite connecting rod.

2. CROSSHEAD GUIDE

- a. Place the crosshead guide gasket on top of the crankcase.
 - b. Lubricate the inside bore of the crosshead guide with light oil.
 - c. Set the crosshead guide over the piston rods and the crossheads, and slowly lower it against the crankcase. Make certain that the crosshead assemblies are started straight in the bores of the crosshead guide to prevent binding when lowering the crosshead guide into position.
 - d. Install the crosshead guide capscrews loosely.
3. Fill the crankcase with oil. See "Lubrication" for proper amount. Squirt oil into the crankshaft, roller bearings, crankshaft journals, and crosshead assemblies so they will have lubrication at start up.
 4. Attach the inspection plate and the inspection plate gasket to the crankcase.

5. PACKING BOX ASSEMBLIES

Refer to the section 'SEAL REPLACEMENT' for packing box assembly. Before installing the packing boxes into the crosshead guide, inspect the piston rods for scoring or roughness. Remove any burrs or sharp edges. Lubricate the piston rods and packing box O-rings with light oil. **The packing installation tool** (see 'Tool List' table) **MUST be used to avoid damaging the packing when starting it over the rod.**

Single-Seal Models

- a. Insert the packing box O-ring into the crosshead guide.
- b. Start the packing box assembly, short end down, over the piston rod and into the counter-bored hole of the crosshead guide.
- c. Install the packing box retainer ring with new nylon locking inserts, and tighten securely.
- d. Repeat the above steps for the remaining packing box.

Double-Seal and Triple-Seal Models

- a. Insert the lower packing box O-ring into the crosshead guide.
- b. Start the packing box assembly, short end down, over the piston rod.

COMPRESSOR ASSEMBLY

- c. After the lower set of packing is started over the piston rod, make sure the oil deflector ring is properly aligned (with the flat side down) over the piston rod. Use the hole in the side of the packing box to center the deflector ring. Once the deflector ring is over the rod, the packing box can be fully inserted.
- d. Install the upper packing box O-ring on the end of the packing box.
- e. Place packing box spacer ring over the O-ring.
- f. Install the packing box retainer ring with new nylon locking inserts, and tighten.
- g. Repeat above steps for the other packing box.

The following applies to Triple-Seal Models only.

- h. Install new O-rings in the bottom of the upper distance piece. A small amount of grease may be used to hold the O-rings in place during assembly.
- i. Set the upper distance piece over the piston rods and against the crosshead guide, loosely install upper distance piece capscrews.
- j. Install each upper packing box O-ring over the piston rods.
- k. Install each upper packing box over the piston rods.

- 6. Rotate the crankshaft by hand a few times, then uniformly tighten the crosshead guide capscrews (and upper distance piece capscrews on triple-seal models) per the Bolt Torque Table.
- 7. New packing must be broken in. Refer to the end of "Seal Replacement".

8. CYLINDER ASSEMBLY

- a. Install new O-rings in the bottom of the cylinder. A small amount of grease may be used to hold the O-rings in place during assembly.
- b. Set the cylinder over the piston rods and against the crosshead guide.
- c. Loosely install the cylinder capscrews.

- 9. Rotate the flywheel by hand to ensure the compressor turns freely.

10. PISTONS

- a. If necessary, replace the piston rings and piston ring expanders (see "Piston Ring Replacement").
- b. Rotate the flywheel by hand to bring one piston rod to top dead center of the cylinder assembly.
- c. Set one (1) thrust washer and one (1) shim down against the shoulder of the piston rod.
- d. Squeeze the piston rings inward, with light pressure, while threading the piston clockwise onto the rod. Tighten with the 3" adjustable spanner wrench.
- e. Repeat steps a - d for the second piston.
- f. Rotate the compressor by hand a number of times to verify that the pistons are centered in the cylinder bores. The pistons must not touch the cylinder walls. If necessary, adjust the cylinder.

- g. Tighten the cylinder capscrews per the Bolt Torque Table in an alternating pattern.
- h. The proper number of shims must be installed under the piston. To check, rotate the flywheel by hand to bring a piston to the top.
 - i. Measure the distance from the top of the piston to the top of the cylinder.
 - ii. If necessary, remove the piston and add or subtract shims accordingly.
 - iii. Repeat steps i. – ii. for the second piston.

HD161	.010" - .025" (.254 - .635 mm)
HD162	.015" - .030" (.381 - .762 mm)
HD163	.025" - .040" (.635 - 1.016 mm)
HD361	.020" - .035" (.508 - .889 mm)
HDL322 / HDL342 HD362 / HDL362	.025" - .040" (.635 - 1.016 mm)
HDL323 / HDL343 HD363 / HDL363	.050" - .065" (1.270 - 1.651 mm)

Table 11 – Piston End Clearance

- i. Replace the nylon locking inserts in the piston retainer nuts.
- j. Thread the piston nuts onto the piston rods and tighten with the spanner wrench.

11. CYLINDER HEAD ASSEMBLY

If the valve assemblies have been removed from the cylinder head, it is easiest to reinstall them before attaching the cylinder head to the cylinder assembly. Refer to "Valve Replacement" for instructions.

- a. Place the cylinder head O-rings in the grooves located on top of the cylinder.
- b. Place cylinder head assembly on the cylinder.
- c. Hand tighten the outer capscrews and center capscrews into the cylinder head.
Note: Gaskets are used on the HD160 series center capscrews.
- d. Uniformly torque the cylinder head capscrews according to the Bolt Torque Table.

- 12. Rotate the compressor by hand to verify that it turns freely. Make sure the pistons are not hitting against the bottom of the cylinder head assembly.
- 13. Refer to the "Pre-Startup Check List", and "Startup Procedure".
- 14. After the compressor has been run for a sufficient enough time to reach operating temperature, allow to cool and retighten the valve hold down screws.

VALVE REPLACEMENT

When replacing the valves, it is important to install the suction and discharge valves in the correct location in the cylinder head.

NOTE: The valves may be removed without removing the cylinder head from the cylinder. Be sure to remove and replace the valve gaskets.

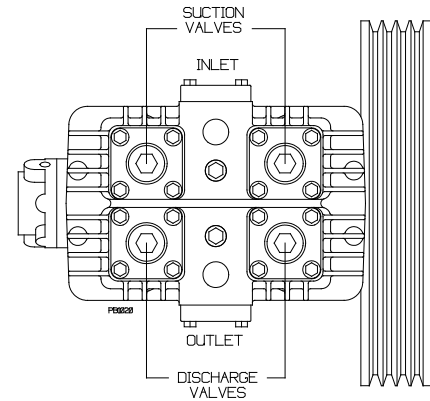

Fig. 10 - Valve Locations



Failure to install compressor valves properly can lead to component failure, personal injury or property damage.

SUCTION

DISCHARGE

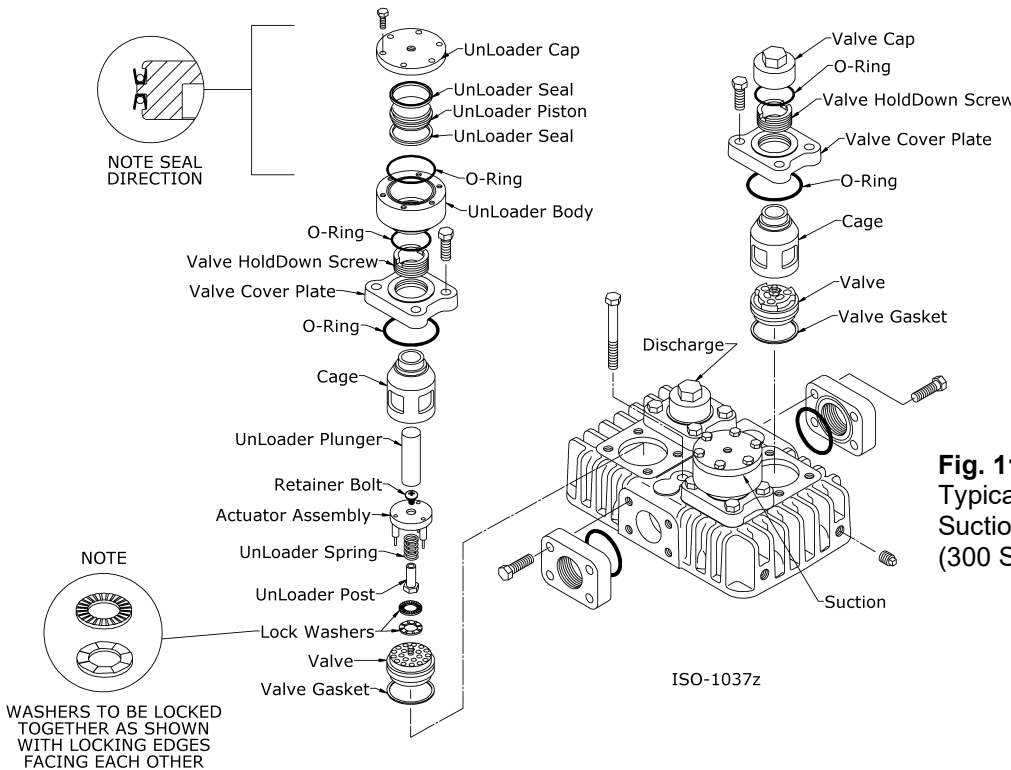
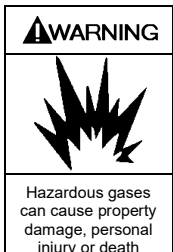
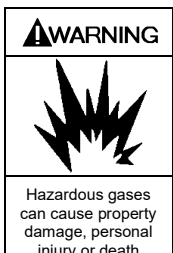

Fig. 11 – Typical Head Assembly with Suction Valve Unloaders. (300 Series shown)



Failure to install compressor valves properly can result in leakage of explosive gas creating an explosion hazard, possibly causing severe personal injury or death.



Failure to install compressor valves properly can result in extreme discharge temperatures. This could be an ignition source in the presence of explosive gas possibly causing severe personal injury or death.

1. Remove the valve cap (or unloader assembly) and O-ring from each valve.
2. **Remove** the valve hold down screw with a valve hold-down ring torque tool (see 'Tool List' table).
3. **Valve Removal and Disassembly**
 - 160 Series Models:
 - a. Remove the valve cage (and unloader plunger, actuator, and spring).
 - b. Remove the valve assembly and the valve gasket.
 - c. Inspect the valve for wear or breakage.
 - Valve Repair
 - i. Unscrew the valve halves and remove the spring and plate.
 - ii. Inspect and replace worn components.
 - iii. Reassemble valves as shown below and tighten the valve halves together.

VALVE REPLACEMENT

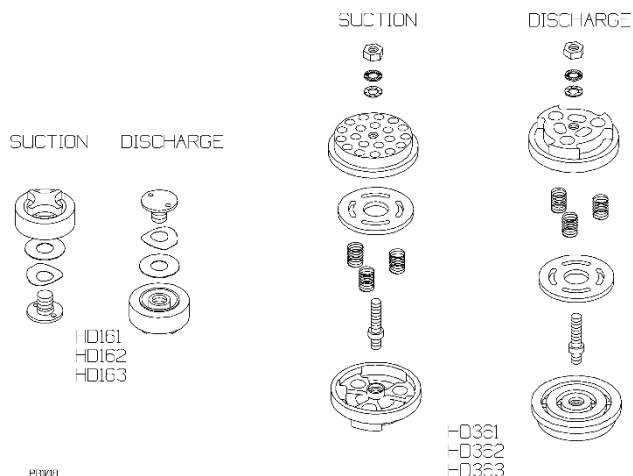

Fig. 12 – Typical Valve Assemblies

320, 340 and 360 Series Models:

- a. Remove the valve cover plate capscrews then lift off the cover plate and O-ring.
 - b. Remove the valve cage (and unloader plunger).
 - c. Remove the valve assembly and valve gasket.
 - d. Inspect the valve for wear or breakage.
 - e. Valve Repair
 - i. Remove hex nut from valve (after removing the unloader post retainer bolt, actuator assembly, spring, and post.)
 - ii. Separate the valve halves and remove springs and plate.
 - iii. Inspect and replace worn components.
 - iv. Reassemble valves as shown in the drawing and tighten the valve assembly nut or unloader post according to the Bolt Torque Table.
 - v. (Reassemble the unloader spring, and actuator then tighten the retainer bolt per the Bolt Torque Table.)
4. To reinstall valves:
- a. Install a new valve gasket into the cylinder head (remove any old gaskets).
 - b. Install the valve assembly in the cylinder head. Make sure the valve's orientation and location are correct.
 - c. Center the valve cage on the valve assembly.
 - d. Applies only to suction valves with unloaders.

160 Series: Install unloader spring, actuator and plunger in the cage.

320, 340 and 360 Series: Install the unloader plunger in the cage.
 - e. 320, 340 and 360 Series Models:

Make sure the valve hold down screw is removed from the cover plate, then install the valve cover plate with a new O-ring. Tighten the cover plate capscrews according to the Bolt Torque Table.
 - f. Install the hold down screw and tighten according to the Bolt Torque Table.

- g. Install the valve cap (or unloader assembly) and O-ring. (A little oil or grease on the O-ring will help hold it in place during installation.)
5. After replacing the valves, rotate the flywheel by hand to check for interference between the pistons and the valves.
 6. After 60 minutes of running time, remove the valve cap (or unloader assembly) and retorque the hold down screw. Replace the valve cap and O-ring.

UNLOADER SEAL REPLACEMENT

1. Remove the unloader cap and O-ring.
2. Remove the unloader body from the cylinder head (a strap wrench is helpful).
3. Push the unloader piston out the top of the unloader body.
4. Inspect and replace the seals as needed - note the seal orientation!
5. Inspect the unloader body bore - it must be clean and smooth.
6. Reassemble in the reverse order.

PISTON RING REPLACEMENT

1. Follow steps 1 through 3 of "Compressor Disassembly."
2. Remove the piston rings and the piston ring expanders from the pistons.
3. To replace the piston rings:
 - a. Place an expander in the top groove of the piston. Place an expander in the second groove with the break in this expander 180 degrees from the break of the top expander. Place the third expander in the bottom groove with its break in the same position as the top expander.
 - b. Place piston rings in all three grooves of the piston. Make sure the breaks in the piston rings are directly opposite the breaks in the corresponding expanders.
4. Reassemble the compressor per steps 10 through 14 of "Compressor Assembly."

SEAL (PACKING) REPLACEMENT

1. Follow the steps in "Compressor Disassembly" to remove the packing boxes.
2. Remove the upper and lower retainer ring from the packing box being serviced. Disassemble the packing box and discard the old packing sets and packing springs.

NOTE: Before reassembling the packing boxes, refer back to "Seal Arrangements". The 6th digit of the Compressor ID# identifies the packing orientation.

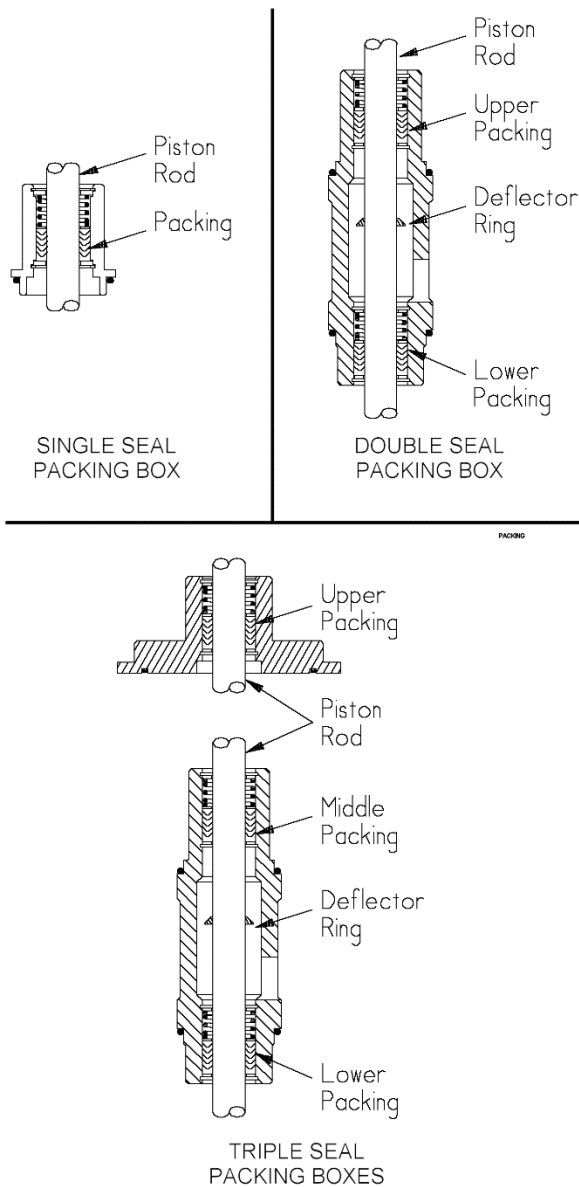

Fig. 13 - Packing Box X-Sections

3. Packing boxes may contain either one or two sets of packing, depending on the compressor being serviced. To reassemble a packing box:
 - a. Clean the packing box in a suitable solvent. Inspect the bore for wear, roughness, or corrosion.

- b. See "Seal Arrangements" (Fig. 6 & 7) for the proper location and orientation of the packing components. Install the first retainer ring (start with the inner ring on two seal packing boxes), then install the packing rings, spring, washers, and the second retainer ring. Note: To ease installation on the second retainer ring, use a screwdriver handle and press on the last washer to compress the seal spring slightly.
- c. Two seal packing boxes only
Insert the oil deflector ring through the top of the packing box, flat side down, into the cavity between the upper and lower packing. **NOTE:** The oil deflector ring will be positioned between the two sets of packing. Install the second set of packing per step b.

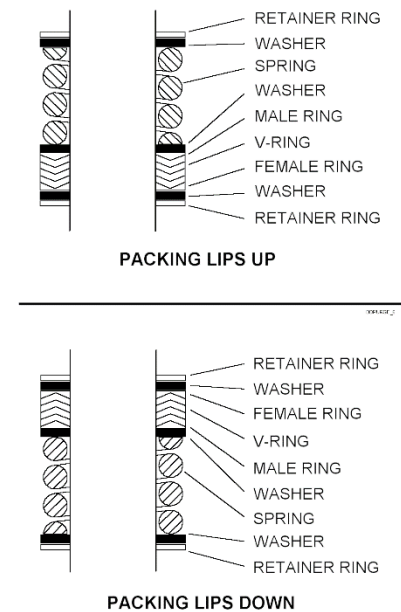

Fig. 14 - Seal Component Orientation

4. Packing Break-in

The lower packing must be manually lubricated with oil several times during the first 60 minutes of compressor operation. This will prevent overheating of the piston rods and potential damage to the packing material. If possible, perform the packing break-in at a lower speed – 400-500 rpm.

To lubricate the packing:

- a. Remove the inspection plate from the crosshead guide.
- b. Run the compressor for 5 minutes then **stop** the compressor for 5 minutes to allow adequate cooling of the piston rods.
- c. Using a small oil can, lubricate the piston rod with 3-4 drops of oil each time the compressor is **stopped**. **DO NOT FLOOD THE ROD WITH EXCESS LUBRICANT.**

SEAL (PACKING) REPLACEMENT

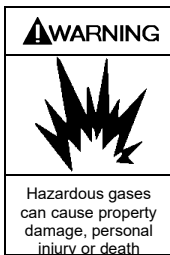

Improper seal installation could release explosive gas to the atmosphere creating an explosion hazard, possibly causing severe personal injury or death.

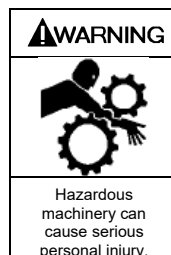

Do not insert objects or fingers in inspection cavity. Can cause severe personal injury

5. Proceed per the "Compressor Assembly" section.

BEARING REPLACEMENT

NOTICE: When replacing the bearings, the entire bearing assembly, including the bearing cup and the bearing cone, must be replaced and the crankshaft endplay must be readjusted.

1. Follow the "Compressor Disassembly" section.
2. Remove the Oil Pump per the section "Oil Pump Replacement."
3. Remove the flywheel.
4. Remove the bearing carrier and gasket from the outboard end of the crankcase. The outboard bearing cup will come off with the bearing carrier and will need to be removed with a bearing removal tool.
5. Remove the key from the crankshaft and slide the crankshaft through the outboard end of the crankcase. The bearing cones can then be removed with a bearing puller.
6. Remove the bearing cover plate from the inboard end of the crankcase. The inboard bearing cup is pressed into the crankcase and can be removed with the use of a bearing removal tool.
7. To install the bearings:

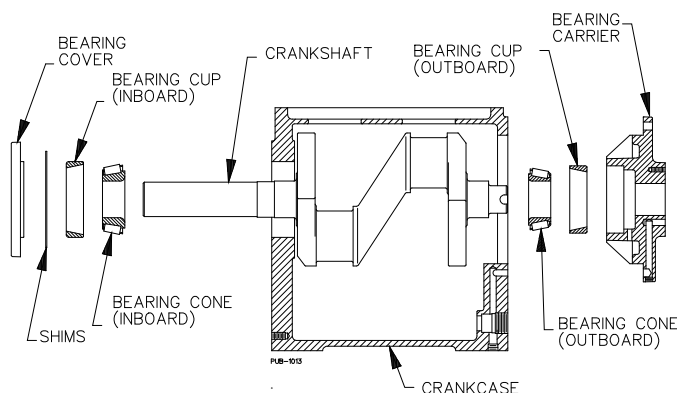

Figure 15 - Bearing Locations

- c. Note the proper orientation and carefully press the outboard bearing cup into the bearing carrier assembly.
- d. Press a bearing cone onto each end of the crankshaft with the tapered end outward. The bearing race should rest against the shoulder on the crankshaft.
- e. Lubricate the bearings with grease.
8. Install the crankshaft through the outboard end of the crankcase.
9. With the oil pump assembly **removed**, install the bearing carrier and new gasket. The bolt hole positions ensure proper orientation. Tighten the bolts evenly per Table 8 - Bolt Torque."
10. If the bearings have not been replaced, reinstall the inboard bearing cover plate using the existing shim set. If the bearings have been replaced, use a **thicker** set of shims.
11. Rotate the crankshaft by hand to verify free movement of the shaft.
 - a. If the crankshaft has an excessive amount of end play, too many shims have been used. Lateral crankshaft movement (end play) between the bearings should be:

End Play at Room Temperature
0.0015 to 0.0030" (0.038 to 0.076 mm)
 - b. If the crankshaft binds, or will not turn, not enough shims have been used pushing the bearing cup too tight against the bearing cone. Remove the crankshaft from the crankcase and drive the inboard bearing cup out toward the inboard side of the crankcase. Reinstall the crankshaft and the bearing cover plate using additional shims as required.
12. Install the oil pump per the "Oil Pump Replacement" section of this manual.
13. Reassemble the compressor according to the "Compressor Assembly" section.

OIL PUMP REPLACEMENT

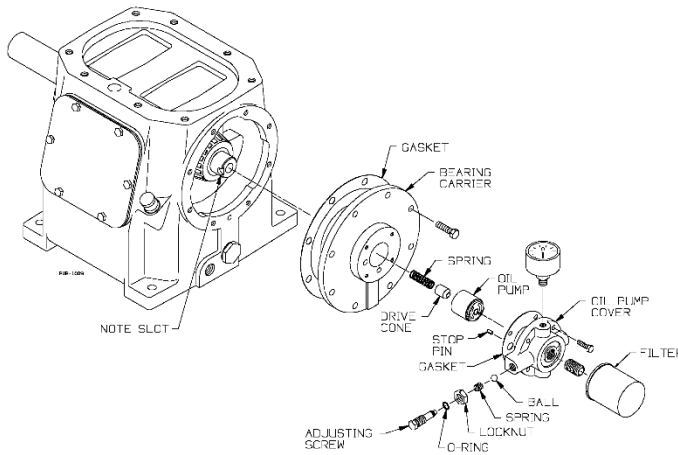

Figure 16 – Oil Pump

1. Remove the oil pump cover bolts and oil pump cover.
2. Remove the oil pump assembly, drive cone and spring.
3. Clean and inspect parts for wear or damage, replace as necessary.

4. Place the spring and the drive cone in the end of the crankshaft.
5. Note the slot in the end of the crankshaft and the drive tab on the back of the oil pump assembly. Install the oil pump assembly into the bearing carrier with the tab and slot aligned.
6. Note the groove around outer edge of the oil pump assembly and the stop pin in the oil pump cover. Position the oil pump cover and new gasket with the pin in the oil pump groove, rotating the oil pump as needed. The bolt hole positions ensure proper orientation of the oil pump cover.
7. **BY HAND**, tighten the oil pump cover bolts while the pump cover is held flush with the bearing carrier.
NOTICE: If by hand tightening, the oil pump cover cannot be drawn flush with the bearing carrier, the drive tab or the stop pin are improperly aligned. DO NOT WRENCH TIGHTEN OR THE OIL PUMP WILL BE DAMAGED.
8. Once the oil pump cover is secured by hand, the bolts may be evenly tightened per Table 8 - "Bolt Torque."

EXTENDED STORAGE PROCEDURES

If a compressor is not to be put into service for some time, or if a compressor is to be taken out of service for an extended period, care must be taken to protect the compressor. The following steps must be taken for both bare compressors and those already piped into a system.

If proper storage procedures are not followed, damage to the compressor may occur. Complete compressor disassembly and replacement of rod packing, bearings and other parts may be required.

1. Keep a written record storage procedures performed – preferably on the unit itself.
2. Fill the crankcase with rust inhibiting oil. (New compressors leave the factory without oil.) Squirt oil on the piston rods and crossheads through the nameplate opening. Loosen the V-belts to relieve the load on the bearings. Rotate the compressor by hand a few times to distribute the oil.
3. Plug all openings and purge the compressor with an inert gas such as nitrogen or **dry** air at about 50 psig (3.5 bar-g). This may be done at the factory if requested. Leave the compressor pressurized to prevent air or moisture from entering the unit.
Check the unit monthly and add additional purge gas as needed.

NOTICE: Tag the unit with a warning that it is pressurized.

4. If a purge gas is not available, fog oil into the compressor suction while rotating the unit. Then plug all openings to keep out moisture, insects, etc.
5. **Turn the flywheel by hand a few revolutions once a month to distribute the oil.**
6. Store the unit under a plastic wrap on its wooden shipping base up off the ground. If the unit was boxed for export shipment, leave it in its box. An indoor or covered storage area is preferable.
7. **Placing the Compressor back in service.**
When the compressor is to be put in service, vent the remaining purge gas and change the crankcase oil. Follow the "Pre-Startup Checklist" and "Startup Procedure" sections in this manual.

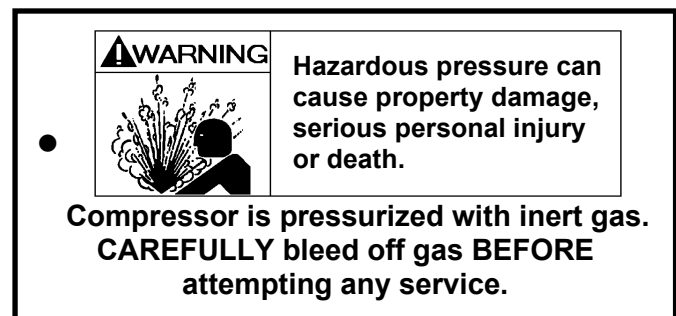

Figure 17 – Pressurized Compressor Tag

TROUBLESHOOTING

Table 12 – Compressor Troubleshooting

PROBLEM	STEP	PROBABLE CAUSE	WHAT TO CHECK	IF PROBLEM STILL EXISTS GO TO STEP ...
Low Transfer Rate	1	4-Way Valve Leaking (when equipped)	Lubricate with a stick lubricant compatible with material being transferred.	2
	2	Worn or Broken Piston Rings	Check condition of rings by restricting discharge line. If pressure increases slowly, rings are probably faulty.	3
	3	Plugged Strainer	Clean screen as necessary.	4
	4	Compressor Valve Faulty	Remove and inspect for broken or worn springs, discs, or bodies.	5
	5	Compressor Drive Slipping	Tighten belts, check for sheared keys, loose keys or loose flywheel.	6
	6	Piping Improperly Designed or Installed	Use proper pipe sizes.	7
Knocks or Other Noises	7	Loose Valves	Tighten valve hold-down screws.	8
	8	Worn Internal Parts	Inspect through inspection plates and repair as necessary.	4
No Oil Pressure	9	Oil Pump Relief Valve Not Properly Set.	Set oil pump relief valve.	10
	10	Oil Pump Not Working	Check the Oil Pump drive tab or stop pin for damage.	11
	11	Low Oil Level	Check and fill as necessary	12
	12	Dirty Oil Inlet Strainer	Clean Oil Inlet Strainer	
Gas Leaking from Crankcase Breather	13	Faulty/Worn Packing	Replace Packing.	14
	14	Piston Rod Scored	Replace crosshead assemblies and packing.	15
	15	Improper Seal Arrangement	See "Seal Arrangements."	---
Relief Valve Actuates	16	Valve Closed Downstream of the Compressor	Open Valve	17
	17	Line Blockage Downstream of the Compressor	Locate Blockage and Correct	---
Shake or Vibration	18	Loose/Broken Mounting or Anchor Bolts	See "Mounting the Compressor Unit"	19
	19	Improper Mounting	Ensure base is supported full length. See "Mounting the Compressor."	20
	20	Improperly Aligned V-belt Sheaves	See "V-Belt Drives"	21
	21	Improperly Installed Flywheel	See "Compressor Flywheel"	22
	22	Nonfunctioning Valves	Replace or repair valves.	---



1809 Century Avenue, Grand Rapids, Michigan 49503 U.S.A.
(616) 241-1611 • Fax: (616) 241-3752 • www.blackmer.com