

BLACKMER POWER PUMPS

INSTALLATION OPERATION AND MAINTENANCE INSTRUCTIONS MODELS: CRL8A

960253
INSTRUCTIONS NO. 701-D00

Section Effective Replaces	701 Mar 2016 Jan 2014
----------------------------	-----------------------------

SAFETY DATA

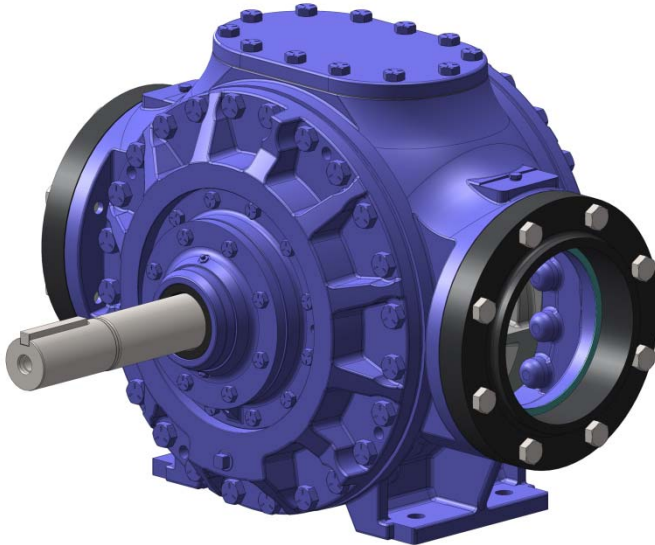

PUMP DATA

Technical Data.....	2
Initial Pump Start Up Information.....	2

INSTALLATION

Pre-Installation Cleaning.....	3
Location and Piping.....	3
Pump Mounting.....	3
Coupling Alignment.....	4
Pump Rotation.....	4
To Change Pump Rotation.....	4
Check Valves.....	4

OPERATION

Pre-Start Up Check List.....	5
Start Up Procedures.....	5
Running the Pump in Reverse Rotation.....	5
Flushing the Pump.....	6
Relief Valve Setting and Adjustment.....	6

MAINTENANCE

Torque Table.....	7
Scheduled Maintenance.....	7
Strainers.....	7
Lubrication.....	7
Pump Disassembly.....	8
Seal/Bearing Replacement.....	8
Complete Pump Disassembly.....	10
Pump Assembly.....	11

TROUBLE SHOOTING.....

Numbers in parentheses following individual parts indicate reference numbers on the Blackmer CRL8A Parts List 701-D01.

Blackmer pump manuals and parts lists may be obtained from Blackmer's website (www.blackmer.com) or by contacting Blackmer Customer Service.



This is a SAFETY ALERT SYMBOL.

When you see this symbol on the product, or in the manual, look for one of the following signal words and be alert to the potential for personal injury, death or major property damage



Warns of hazards that WILL cause serious personal injury, death or major property damage.



Warns of hazards that CAN cause serious personal injury, death or major property damage.



Warns of hazards that CAN cause personal injury or property damage.

NOTICE:

Indicates special instructions which are very important and must be followed.

NOTICE:

Blackmer Power Pumps **MUST** only be installed in systems, which have been designed by qualified engineering personnel. The system **MUST** conform to all applicable local and national regulations and safety standards.

This manual is intended to assist in the installation and operation of Blackmer Power pumps, and **MUST** be kept with the pump.

Pump service shall be performed by qualified technicians **ONLY**. Service shall conform to all applicable local and national regulations and safety standards.

Thoroughly review this manual, all instructions and hazard warnings, **BEFORE** performing any work on the pump.

Maintain **ALL** system and pump operation and hazard warning decals.

SAFETY DATA

⚠ WARNING



Hazardous pressure can cause personal injury or property damage

Disconnecting fluid or pressure containment components during pump operation can cause serious personal injury, death or major property damage

⚠ WARNING



Hazardous voltage. Can shock, burn or cause death.

Failure to disconnect and lockout electrical power before attempting maintenance can cause shock, burns or death

⚠ WARNING



Hazardous machinery can cause serious personal injury.

Failure to disconnect and lockout electrical power or engine drive before attempting maintenance can cause severe personal injury or death

⚠ WARNING



Do not operate without guard in place

Operation without guards in place can cause serious personal injury, major property damage, or death.

⚠ WARNING



Hazardous or toxic fluids can cause serious injury.

If pumping hazardous or toxic fluids, system must be flushed and decontaminated, inside and out, prior to performing service or maintenance

⚠ WARNING



Hazardous pressure can cause serious personal injury or property damage

Failure to relieve system pressure prior to performing pump service or maintenance can cause serious personal injury or property damage.

⚠ CAUTION



Heavy assemblies can cause personal injury or property damage.

Always use a lifting device capable of supporting the full weight of the pump assemblies.

⚠ WARNING



Hazardous machinery can cause serious personal injury.

Failure to set the vehicle emergency brake and chock wheels before performing service can cause severe personal injury or property damage

PUMP DATA

PUMP IDENTIFICATION

A pump Identification tag, containing the pump serial number, I.D. number, and model designation, is attached to each pump. It is recommended that the data from this tag be recorded and filed for future reference. If replacement parts are needed, or if information pertaining to the pump is required, this data must be furnished to a Blackmer representative.

TECHNICAL DATA *

	CRL8A
Maximum Pump Speed	350 RPM
Maximum Operating Temperature	250°F (121°C)
Minimum Operating Temperature	-30°F (-34°C)
Maximum Differential Pressure	100 psi (6.8 Bar)
Maximum Working Pressure	400 psi (27.5 Bar)

* Technical Data is for standard materials of construction. Consult Blackmer Material Specs for optional materials of construction.

INITIAL PUMP START UP INFORMATION

Model No.	_____
Serial No.	_____
ID No.	_____
Date of Installation:	_____
Inlet Gauge Reading:	_____
Discharge Gauge Reading:	_____
Flow Rate:	_____

INSTALLATION

NOTICE:

Blackmer power pumps must only be installed in systems designed by qualified engineering personnel. System design must conform with all applicable regulations and codes and provide warning of all system hazards.

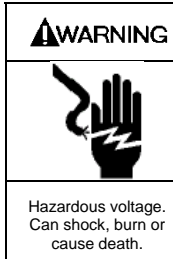

- ⚠ Install, ground and wire to local and National Electrical Code requirements.
- ⚠ Install an all-leg disconnect switch near the unit motor.
- ⚠ Disconnect and lockout electrical power before installation or service
- ⚠ Electrical supply **MUST** match motor nameplate specifications.

⚠ Motors equipped with thermal protection automatically disconnect motor electrical circuit when overload exists. Motor can start unexpectedly and without warning.

WELDED CONNECTIONS

NOTICE:

Pumps with welded connections contain three non-metallic gaskets that may be damaged if welding is done with these gaskets installed.

Prior to welding the piping, remove the gaskets from under the inlet flange, outlet flange and relief valve cover.

Reinstall the inlet and outlet flanges. Weld the piping to the the inlet and outlet flanges. After the welding is complete, reinstall the gaskets, cover and flanges.

PRE-INSTALLATION CLEANING

NOTICE:

New pumps might contain residual test fluid and/or rust inhibitor. If necessary, flush pump prior to use.

Foreign matter entering the pump WILL cause extensive damage. The supply tank and intake piping MUST be cleaned and flushed prior to pump installation and operation.

LOCATION AND PIPING

An improperly designed piping system or improper unit installation WILL significantly reduce pump performance and life. Blackmer recommends the following piping system layout and unit installation.

1. To minimize intake losses, locate the pump as close as possible to the source of supply.
2. Intake piping and fittings MUST be at least as large in diameter as the pump intake connection. It should slope downward to the pump, and should not contain any upward loops.
3. Minimize the number of intake line fittings (valves, elbows, etc.) and piping turns or bends. When used, intake fittings must be located at least 5 - 10 pipe diameters from the pump intake.
4. Install an intake strainer 5 - 10 pipe diameters from the pump intake. The strainer should have a net open area of at least four times the area of the intake pipe.
5. Strainers must be cleaned regularly to avoid pump starvation.
6. Intake and discharge piping MUST be free of all leaks.

7. Expansion joints, placed at least 36" (0.9m) from the pump, will compensate for expansion and contraction of the pipes. Contact the flexible connector/hose manufacturer for required maintenance/care and design assistance in their use.
8. Install pressure gauges in the NPT ports provided in the pump casing to check pump at start up.
9. ALL piping and fittings MUST be properly supported to prevent any piping loads from being placed on the pump.
10. Check alignment of pipes to pump to avoid strains which might later cause misalignment. See Figure 1. Unbolt flanges or break union joints. Pipes should not spring away or drop down. After pump has been in operation for a week or two, completely recheck alignment.

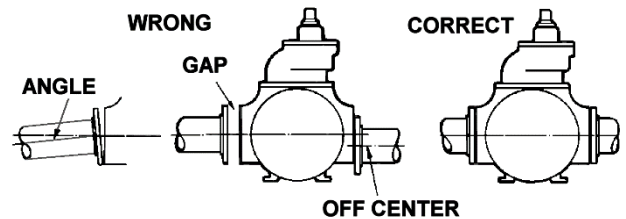

Figure 1

11. The use of a 4" (100mm) vapor return line will speed delivery by preventing pressure build up at the receiving tank and pressure reduction in the supply tank.
12. Keeping the liquefied gas systems full of liquid, even when idle, will keep the O-rings from changing shape, shrinking or super cooling. Evaporation of liquefied gas leaves an abrasive powder on the surface which can cause wear to the pump, meter, and seals.

PUMP MOUNTING

Permanently mount the unit by securing the base plate with adequately sized anchor bolts to a level concrete floor following recommended industry standards. A solid foundation will reduce system noise and vibration, and will improve pump performance. Refer to ANSI/HI standards or a suitable pump handbook for information on typical pump mounting and foundations. Check coupling alignment after pump and base assembly is secured to the foundation.

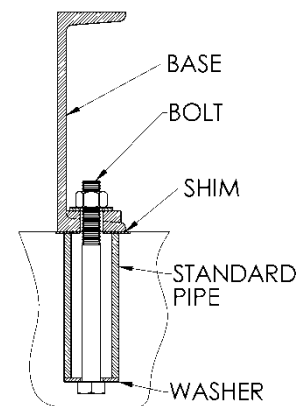

Figure 2 - Pipe Type Anchor Bolt Box

When installing units built on channel or structural steel type bases, use care to avoid twisting the base out of shape when anchor bolts are tightened. Shims should be used under the edges of the base prior to tightening of the anchor bolts to prevent distortion. See figure 2 for proper orientation

INSTALLATION

COUPLING ALIGNMENT

The pump must be directly coupled to a gear and/or driver with a flexible coupling. Verify coupling alignment after installation of new or rebuilt pumps. Both angular and parallel coupling alignment **MUST** be maintained between the pump, gear, motor, etc. in accordance with manufacturer's instructions. See Figure 3.

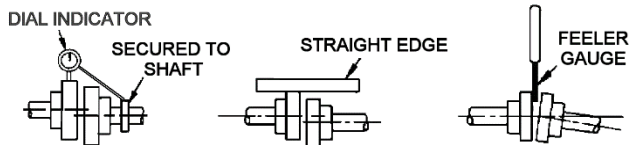
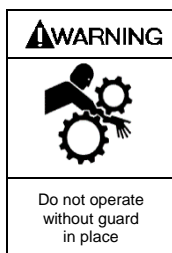

Figure 3 – Alignment Check

1. Parallel alignment: The use of a laser alignment tool or dial indicator is preferred. If a laser alignment tool or dial indicator is not available, use a straightedge. Turn both shafts by hand, checking the reading through one complete revolution. Maximum offset should be less than .005" (0.127 mm).
2. Angular alignment: Insert a feeler gauge between the coupling halves. Check the spacing at 90° increments around the coupling (four check points). Maximum variation should not exceed .005" (125 microns). Some laser alignment tools will check angular alignment as well.
3. Replace the coupling guards after setting alignment.



Operation without guards in place can cause serious personal injury, major property damage, or death.

Do not operate without guard in place

PUMP ROTATION

To determine pump rotation:

If the intake port is on the right, with the drive end of the shaft pointing towards the observer, the pump is **right-hand**, or **CLOCKWISE** rotation.

If the intake is on the left, with the drive end of the shaft pointing towards the observer, the pump is **left-hand**, or **COUNTERCLOCKWISE** rotation.

NOTICE:

Confirm correct pump rotation by checking the pump rotation arrows respective to pump driver rotation.

TO CHANGE PUMP ROTATION

To change pump rotation the pump must be disassembled and the liner (41), vanes (14) and pump mounted relief valve (if equipped) must be reversed. Refer to "Pump Disassembly" and "Pump Assembly" sections of this manual for parts removal and replacement instructions.

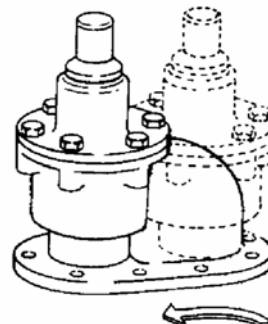

Figure 4 – Reversing the Relief Valve

CHECK VALVES

If a check valve is used, install it at the pump discharge. The use of check valves or foot valves in the supply tank is not recommended with self-priming, positive displacement pumps.

If the possibility of liquid backflow exists when the pump is off, a check valve in the pump discharge piping is recommended because the pump can motor in the reverse rotation and create undue stress on all attached components. Never start a pump when it is rotating in the reverse rotation as the added starting torque can damage the pump and related equipment.

INTERNAL PUMP RELIEF VALVE AND EXTERNAL BYPASS VALVE

NOTICE:

The optional pump internal relief valve is designed to protect the pump from excessive pressure and must not be used as a system pressure control valve.

For ALL liquefied gas applications, install an external bypass valve, and any necessary piping, back to the tank. **DO NOT** pipe the bypass valve back to the intake line. The setting on the external bypass valve must be at least 25 psi (1.7 bar) lower than the pump internal relief valve setting. The valve and piping must be of adequate size to accommodate the full flow from the pump when the discharge line is closed.

OPERATION

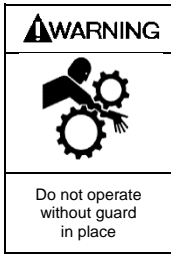

Operation without guards in place can cause serious personal injury, major property damage, or death.

Do not operate without guard in place

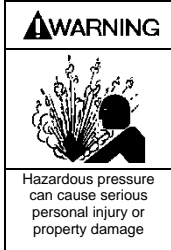

Disconnecting fluid or pressure containment components during pump operation can cause serious personal injury, death or major property damage

Hazardous pressure can cause serious personal injury or property damage

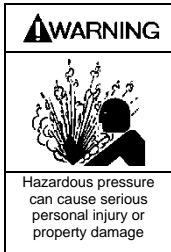

Failure to relieve system pressure prior to performing pump service or maintenance can cause serious personal injury or property damage.

Hazardous pressure can cause serious personal injury or property damage

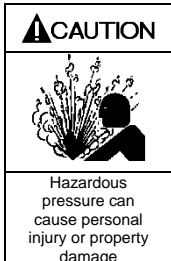

Pumps operating against a closed valve can cause system failure, personal injury and property damage

Hazardous pressure can cause personal injury or property damage

PRE-STARTUP CHECK LIST

1. Check the alignment of the pipes to the pump. Pipes must be supported so that they do not spring away or drop down when pump flanges or union joints are disconnected.
2. Verify proper coupling alignment.
3. Install pressure gauges in the 1/4" NPT intake and discharge ports located on the pump casing to check pump performance after start-up.
4. Ensure all valves and fittings in piping system are in the start-up or operating positions.
5. Check the wiring of the pump motor and jog the pump motor to verify proper pump rotation.

STARTUP PROCEDURES

NOTICE:

Consult the "General Pump Troubleshooting" section of this manual if difficulties during start up are experienced.

1. SLOWLY build pressure in the pump.
2. Start the motor. Priming should occur within one minute.
3. Check the inlet and discharge pressure gauges to ensure the system is operating within expected parameters. Record the gauge readings in the "Initial Start Up Information" section of this manual.
4. Inspect piping, fittings, and associated system equipment for leaks, noise, vibration and overheating.
5. Check the flow rate to ensure the pump is operating within the expected parameters. Record flow rate in the "Initial Start Up Information" section.
6. Check the pressure setting of the relief valve by momentarily closing a valve in the discharge line and reading the pressure gauge. This pressure should be 10 -20 psi (0.7-1.4 bar) higher than the maximum system operating pressure, or the external system pressure control valve setting (if equipped). **DO NOT operate the pump against a closed discharge valve for more than 15 seconds.** If adjustments are needed, refer to the "Relief Valve Setting and Adjustment" section of this manual.
7. The external bypass valve must always be set at least 25 PSI (1.7 bar) lower than the internal pump relief valve. NOTE: The normal operating pressure must be at least 5 - 15 PSI (0.3 -1.0 bar) less than the external bypass valve setting. Pump speeds which result in higher pressures (nearing the valve setting) forces the liquid to recirculate, creating excessive wear on the pump and equipment.

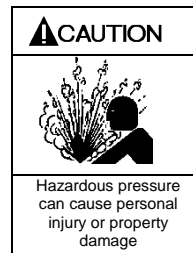

Incorrect settings of the pressure relief valve can cause pump component failure, personal injury, and property damage.

Hazardous pressure can cause personal injury or property damage

RUNNING THE PUMP IN REVERSE ROTATION

NOTICE:

Pump should be operated in reverse rotation for no more than 10 minutes and only when a separate pressure relief valve is installed to protect the pump from excessive pressure.

It may be desirable to run the pump in reverse rotation for system maintenance. The pump will operate satisfactorily in reverse rotation for a LIMITED time, at a reduced performance level.

OPERATION

FLUSHING THE PUMP

NOTICE:

If flushing fluid is to be left in the pump for an extended time, it must be a lubricating, non-corrosive fluid. If a corrosive or non-lubricating fluid is used, it must be flushed from the pump immediately.

1. To flush the pump, run the pump with the discharge valve open and the intake valve closed. Bleed air into the pump through the intake gauge plug hole or through a larger auxiliary fitting in the intake piping. Pump air for 30 second intervals to clean out most of the pumpage.
2. Run a system compatible flushing fluid through the pump for one minute to clear out the remainder of the original pumpage.
3. To remove the flushing fluid, follow step 1 above.

NOTICE:

After flushing the pump some residual fluid will remain in the pump and piping.

NOTICE:

Properly dispose of all waste fluids in accordance with the appropriate codes and regulations.

RELIEF VALVE SETTING AND ADJUSTMENT



Incorrect settings of the pressure relief valve can cause pump component failure, personal injury, and property damage.

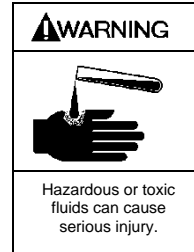

Relief valve cap is exposed to pumpage and will contain some fluid

The factory relief valve pressure setting is marked on a metal tag attached to the valve cover. The relief valve must be set at least 10 - 20 psi (0.7-1.4 bar) higher than the maximum system operating pressure or the system pressure control valve setting.

DO NOT remove the R /V Cap OR adjust the relief valve pressure setting while the pump is in operation.

1. **To INCREASE the pressure setting**, remove the relief valve cap, loosen the locknut, and turn the adjusting screw *inward*, or clockwise. Replace the valve cap.
2. **To DECREASE the pressure setting**, remove the relief valve cap, loosen the locknut, and turn the adjusting screw *outward*, or counterclockwise. Replace the valve cap.

Refer to the individual Blackmer pump parts lists for various spring pressure ranges. Unless specified otherwise, pumps are supplied from the factory with the relief valve adjusted to the mid-point of the spring range.

MAINTENANCE

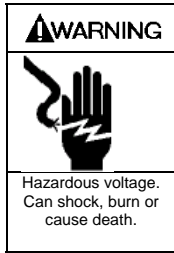

Failure to disconnect and lockout electrical power before attempting maintenance can cause shock, burns or death

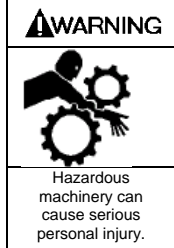

Failure to disconnect and lockout electrical power or engine drive before attempting maintenance can cause shock, burns or death

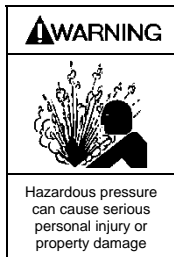

Failure to relieve system pressure prior to performing pump service or maintenance can cause serious personal injury or property damage. Systems with meters will still be pressurized even after the hose is emptied

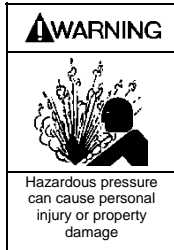

Disconnecting fluid or pressure containment components during pump operation can cause serious personal injury, death or major property damage

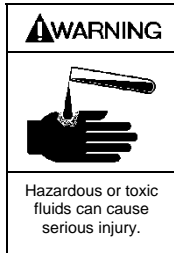

If pumping hazardous or toxic fluids, system must be flushed and decontaminated, inside and out, prior to performing service or maintenance

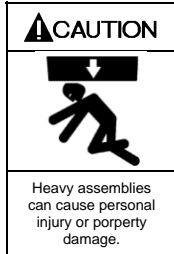

Always use a lifting device capable of supporting the full weight of the pump assemblies.

NOTICE:

Maintenance shall be performed by qualified technicians only, following the appropriate procedures and warnings as presented in this manual.

TORQUE TABLE

Capscrew Torque Values			
	Head	Hub	Bearing Cover
CRL8	178 lbs-ft. (241 Nm)	50 lbs-ft. (68 Nm)	50 lbs-ft. (68 Nm)

SCHEDULED MAINTENANCE

STRAINERS

Strainers must be cleaned regularly to avoid pump starvation. Schedule will depend upon the application and conditions.

LUBRICATION

NOTICE:

To avoid possible entanglement in moving parts do not lubricate pump bearings, gear reducer or any other parts while the pump is running.

NOTICE:

If pumps are repainted in the field, ensure that the grease relief fittings (76A) are functioning properly after painting. Do NOT paint them closed. Remove any excess paint from the fittings.

Ball bearings must be lubricated every three months at minimum. More frequent lubrication may be required depending on the application and operating conditions.

Recommended Grease:

Dow Corning® - MOLYKOTE 44
DuPont® - KRYTOX GPL 203

NOTICE:

Use ONLY recommended grease. Using petroleum based grease or oil to lubricate seal O-rings WILL cause seal O-ring damage and subsequent product leakage.

Greasing Procedure:

1. Remove the grease relief fittings (76A) from the bearing covers (27 and 27A).
2. SLOWLY apply grease with a hand gun until grease begins to escape from the grease relief fitting port. Discard excess grease in accordance with proper codes and regulations.
3. Replace the grease relief fittings (76A).
DO NOT overgrease pump bearings. While it is normal for some grease to escape from the grease tell-tale hole after lubrication, excessive grease can cause mechanical seal failure. The tell-tale hole is located in the head or hub between the bearing and the seal.
Lubricate the ball bearings, and hydraulic motor couplings (if equipped), every three months at a minimum

MAINTENANCE

PUMP DISASSEMBLY

NOTICE:

Follow all hazard warnings and instructions provided in the "Maintenance" section of this manual.



Always use a lifting device capable of supporting the full weight of the pump assemblies.

NOTICE:

Use a hoist and appropriate sling or lifting lugs attached to the baseplate to lift the entire pump assembly. Eyebolts attached to the pump, gearbox, or motor must be used to lift that particular component only.

NOTICE:

Use a hoist and eyebolts installed in the threaded holes located in the heads, discs, rotor and casing to lift the heavy pump parts.

Note: If a seal, bearings or vanes are to be replaced, the pump may be left in the upright (shaft horizontal) position. If the rotor-shaft or liner is to be removed, the pump will have to be placed on its side (shaft vertical) for some operations.

CRL8 pumps are equipped with hubs (20C) which allow for bearing (24) and seal (153) replacement without disturbing the pump head bolts (21). This document covers both the "Seal or Bearing only" Disassembly/Reassembly and "Complete pump" Disassembly/Reassembly

FOR SEAL AND/OR BEARING ONLY REPLACEMENT

1. Flush the pump per instructions in this manual. Drain and relieve pressure from the pump and system as required. A 3/4" drain plug (29) is fitted in each head.
2. **With the pump upright (shaft horizontal).** Clean the pump shaft thoroughly, making sure the shaft is free of nicks and burrs. This will prevent damage to the mechanical seal when the inboard hub or head assembly is removed.
3. Remove the inboard bearing cover capscrews (28) and slide the inboard bearing cover (27A) and gasket (26) off the shaft. Discard the bearing cover gasket.
4. Removing the locknuts and lockwashers (24A and 24B):
 - a. Bend up the engaged lockwasher tang and rotate the locknut counterclockwise to remove it from the shaft
 - b. Slide the lockwasher off the shaft. Inspect the lockwasher for damage and replace as required.
5. Move to the outboard side of the pump and remove the outboard bearing cover capscrews (28) and slide the outboard bearing cover (27) and gasket (26) off the shaft. Discard the bearing cover gasket.

6. Bend up the engaged lockwasher tang and tighten the locknut (24A) on outboard end until shaft cannot be rotated by hand. This will ensure proper rotor/shaft (13) alignment during reassembly.
7. Return to the inboard side of the pump and wrap the shaft threads with tape to ensure that grease seal (104A) is not damaged upon hub removal.
8. Remove the capscrews (21A) from the inboard hub (20C) and slide the hub assembly off the shaft. The bearing (24), grease seal carrier assembly (104B, 104A and 104C), stationary seat (153B) and stationary O-ring (153D) of the mechanical seal will come off with the hub.
 - a. Pull the bearing (24) and grease seal carrier assembly (104B, 104A and 104C) from the housing in the hub.
 - b. If worn or damaged, remove the grease seal (104A) from the carrier (104B).
 - c. To remove the mechanical seal stationary seat (153B), remove the seal retaining screws and washers (153Q, 153R). Gently push the backside of the stationary seat from the seal recess. Place a cloth under the seal to avoid damage. Be careful not to contact the polished face of the seal during removal. Remove and discard mechanical seal stationary O-ring.

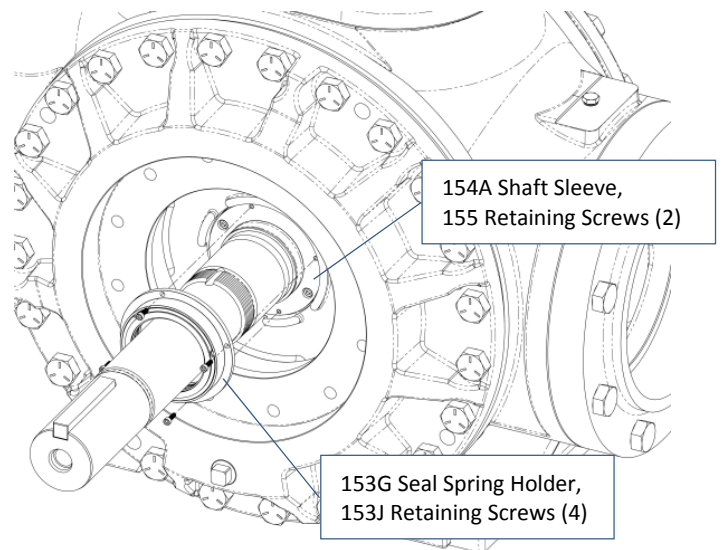

Figure 6 – Seal removal and Installation

9. Remove the remaining mechanical seal parts, including the seal spring holder, springs, retaining ring, rotating O-ring and face (153G, 153H, 153N, 153L, 153F) from the shaft sleeve (154) by removing capscrews (153J). See Figure 6. Take care to protect the carbon rotating face from damage during disassembly. Remove and discard rotating O-ring.

MAINTENANCE

10. Inspect shaft sleeve (154A). If replacement is necessary, remove capscrews (155), set aside. If necessary, use seal mounting holes as jackscrew holes to assist disassembly. See Figure 7 Discard stationary O-ring (154B).

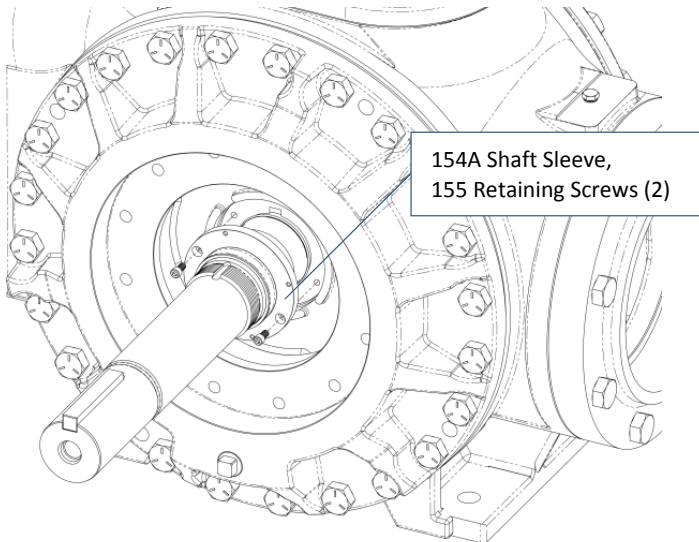

Figure 7 – Shaft sleeve removal and installation

11. To install new shaft sleeve (154A):
 - a. Lubricate inner O-ring (154B) using bearing grease identified in lubrication section of this manual. Install sleeve over shaft while aligning mounting holes with corresponding threaded holes in rotor. Sleeve should mount flush with rotor
 - b. Place small amount of Loctite # 220 onto capscrews (155), thread fully into rotor holes through sleeve. Torque to 200 inlbf (22.6 Nm).
12. Lightly lubricate shaft sleeve surface with bearing grease identified in lubrication section of this manual.
13. Install seal rotating assembly minus carbon rotating face onto shaft sleeve. Take care to align mounting holes with corresponding holes on shaft sleeve.
14. Place small amount of Loctite # 220 onto seal mounting capscrews (153J). Install into corresponding threaded holes on seal sleeve. Torque capscrews (153J) to 20 inlbf (2.25 Nm).
15. Lightly lubricate inner O-ring (153L) on carbon rotating face using bearing grease identified in this manual. Take care to keep seal face free from grease.

NOTICE:

Use ONLY recommended grease. Using petroleum based grease or oil to lubricate seal O-rings WILL cause seal O-ring damage and subsequent product leakage.

16. Install carbon rotating face (153F) and O-ring (153L) over shaft sleeve (154A) while aligning drive notches in carbon with drive pins in seal rotating assembly. (see figure 8)

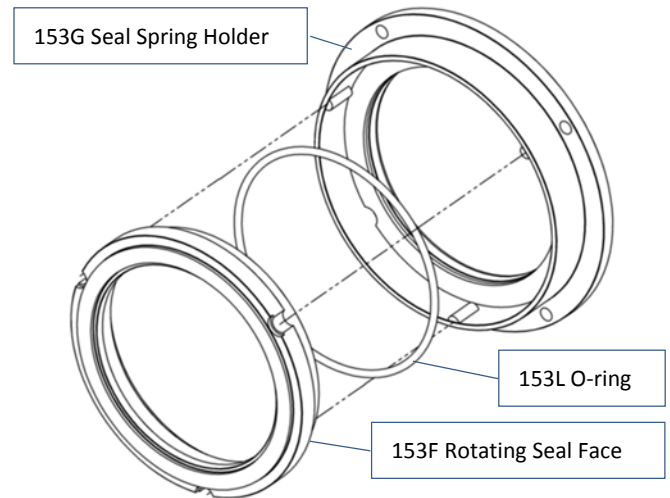

Figure 8 – Seal carbon alignment

17. Install a new stationary O-ring (153D) in the stationary seat (153B). Clean the polished face with a clean tissue and alcohol. Push the seat fully into the hub seal recess with the polished face outward.
18. Apply small amount of Loctite # 220 to seal retaining screws. Install seal retaining screws and washers (153Q, 153R).
19. If removed, press the grease seal (104A) into the grease seal carrier (104b) with the lips facing toward the bearing. Place the grease seal carrier (104B) with new O-ring (104C) into the hub (20C).
20. Hand pack the ball bearing (24) with grease. Refer to the "Lubrication" section for the recommended grease.
21. Install the bearing into the recess of the hub (20C).
22. Temporarily attach the bearing cover (27) and gasket (26) to hub and hand tighten capscrews (28).
23. Install new hub O-ring (72B) and carefully install the hub assembly (20C) on head. Install and tighten hub capscrews (21A) torquing as indicated in the "Torque Table" in maintenance section of this manual
24. Remove bearing cover and install locknut and new lockwasher until snug.
25. Loosen locknut on the outboard end of pump
26. Tighten locknut on near side
27. Repeat steps 7-24 for seal and/or bearing replacement of opposite side of pump
28. Adjust locknuts per "Locknut Adjustment" instructions in maintenance section of this manual

MAINTENANCE

VANE REPLACEMENT AND/OR COMPLETE PUMP DISASSEMBLY

NOTICE:

Follow all hazard warnings and instructions provided in the "Maintenance" section of this manual.



Always use a lifting device capable of supporting the full weight of the pump assemblies.

NOTICE:

Use a hoist and appropriate sling or lifting lugs attached to the baseplate to lift the entire pump assembly. Eyebolts attached to the pump, gearbox, or motor must be used to lift that particular component only.

NOTICE:

Use a hoist and eyebolts installed in the threaded holes located in the heads, discs, rotor and casing to lift the heavy pump parts.

Note: If a seal or vanes are to be replaced, the pump may be left in the upright position. If the rotor-shaft or liner is to be removed, the pump will have to be placed on its side for some operations.

1. Flush the pump per instructions in this manual. Drain and relieve pressure from the pump and system as required. A 3/4" drain plug (29) is fitted in each head.
2. **With the pump upright (shaft horizontal).** Clean the pump shaft thoroughly, making sure the shaft is free of nicks and burrs. This will prevent damage to the mechanical seal when the inboard hub or head assembly is removed.
3. Remove the inboard bearing cover capscrews (28) and slide the inboard bearing cover (27A) and gasket (26) off the shaft. Discard the bearing cover gasket.
4. Removing the locknuts and lockwashers (24A and 24B):
 - a. Bend up the engaged lockwasher tang and rotate the locknut counterclockwise to remove it from the shaft
 - b. Slide the lockwasher off the shaft. Inspect the lockwasher for damage and replace as required.
5. Move to the outboard side of the pump and remove the outboard bearing cover capscrews (28) and slide the outboard bearing cover (27) and gasket (26) off the shaft. Discard the bearing cover gasket.
6. Bend up the engaged lockwasher tang and tighten the locknut (24A) on outboard end until shaft cannot be rotated by hand. This will ensure proper rotor/shaft (13) alignment during reassembly.
7. Return to the inboard side of the pump and wrap the shaft threads with tape to ensure that grease seal (104A) is not damaged upon hub removal.
8. Remove the capscrews (21A) from the inboard hub (20C) and slide the hub assembly off the shaft. The bearing (24), grease seal carrier assembly (104B, 104A and 104C), stationary seat (153B) and stationary O-ring (153D) of the mechanical seal will come off with the hub.
 - a. Pull the bearing (24) and grease seal carrier assembly (104B, 104A and 104C) from the housing in the hub.
 - b. If worn or damaged, remove the grease seal (104A) from the carrier (104B).
 - c. To remove the mechanical seal stationary seat (153B), remove the seal retaining screws and washers (153Q, 153R). Gently push the backside of the stationary seat from the seal recess. Place a cloth under the seal to avoid damage. Be careful not to contact the polished face of the seal during removal. Remove and discard mechanical seal stationary O-ring.
9. Remove the remaining mechanical seal parts, including the seal spring holder, springs, retaining ring, rotating O-ring and face (153G, 153H, 153N, 153L, 153F) from the shaft sleeve (154) by removing capscrews (153J). See Figure 6. Take care to protect the carbon rotating face from damage during disassembly. Remove and discard rotating O-ring.
10. Inspect shaft sleeve (154A). If replacement is necessary, remove capscrews (155), set aside. If necessary, use seal mounting holes as jackscrew holes to assist disassembly. See Figure 7 Discard stationary O-ring (154B).
11. To install new shaft sleeve (154A):
 - a. Lubricate inner O-ring (154B) using bearing grease identified in lubrication section of this manual. Install sleeve over shaft while aligning mounting holes with corresponding threaded holes in rotor. Sleeve should mount flush with rotor
 - b. Place small amount of Loctite # 220 onto capscrews (155), thread fully into rotor holes through sleeve. Torque to 200 inlb (22.6 Nm).
12. Remove the head capscrews (21). If necessary, place head capcrews in the two tapped holes near the outer rim of the head and tighten until the head separates from the casing. Use a hoist to remove the head from the casing, being careful not to damage the shaft.
13. Remove the head O-ring (72) and disc (71). If needed, threaded holes are provided in the disc to break it free.
14. Remove the top vane then rotate the shaft by hand to bring the next vane to the top until all the vanes have been removed. If the vanes are swollen or jammed in their slots, the rotor-shaft must be removed.
15. If doing a vane-only replacement, skip to step 10 of COMPLETE PUMP ASSEMBLY section of this manual for pump reassembly
16. If full pump disassembly required, loosen and remove outboard locknut (24A) and lockwasher (24B).
17. Set the pump on its side (shaft vertical) with the shaft pointing up.
18. Attach a hoist to rotor-shaft, lift it out and set it aside. The pushrods, and rotating portions of the seal will come out with the rotor-shaft..
19. Set the pump upright (feet down).
20. Remove the outboard head components as described for the inboard side in steps 7-12.
21. Attach a hoist to the liner. Use a block of wood or piece of brass against the end of the liner, and drive the liner out of the casing with a hammer by tapping the outside diameter of the liner.

MAINTENANCE

COMPLETE PUMP ASSEMBLY

Before reassembling the pump, inspect all component parts for wear or damage, and replace as required. Wash out the bearing/seal recess of the head and remove any burrs or nicks from the rotor and shaft. Remove any burrs from the liner.

NOTICE:

Use a hoist and eyebolts installed in the threaded holes located in the heads, discs, rotor and casing to lift the heavy pump parts.



Always use a lifting device capable of supporting the full weight of the pump assemblies.

- Set the pump casing upright (feet down).
- The liner must be installed in the pump casing with the word "INTAKE" cast on the liner toward the intake port of the pump casing.
Align the keyway in the top of the liner with the pin in the top of the casing.
Uniformly tap the outer edge of the liner with a rubber mallet to fully insert into the casing.
- Start assembly on the **OUTBOARD** non-driven side of the pump:
For a **CLOCKWISE** rotation pump, the **INTAKE** port is to the **left**.
For a **COUNTERCLOCKWISE** rotation pump, the **INTAKE** port is to the **right**.
Loosely assemble the outboard disc (71) and head (20) to the casing (12). The bearing, seal, O-rings, etc. will be installed later.
- Set the pump on its side with the outboard head **DOWN**.

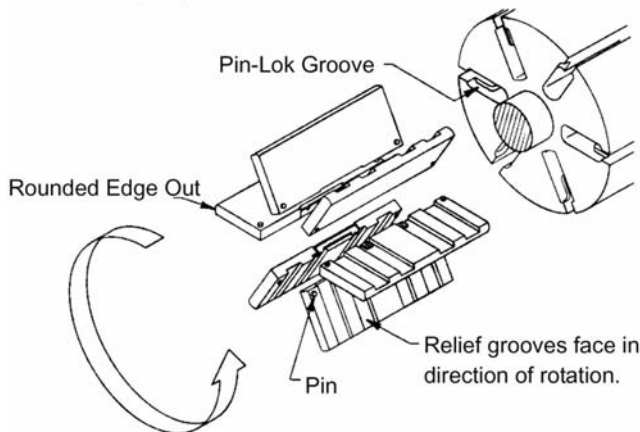

Figure 5 – Vane Installation

- Remove the vanes (14) and push rods (77) from the rotor and shaft assembly. Inspect for wear and damage, and replace as follows:
 - Insert the three push rods (77) into the rotor.
 - Using a hoist, lower the non-driven end of the rotor and shaft into the open side of the pump casing, being careful not to hit the disc with the shaft.
 - Insert the vanes into the rotor slots with the relief grooves facing in the direction of pump rotation, and with the rounded edges outward. See Figure 5.
- If shaft sleeve (154A) previously removed, lubricate inner O-ring (154B) using bearing grease identified in lubrication section of this manual. Install sleeve over shaft while aligning mounting holes with corresponding threaded holes in rotor. Sleeve should mount flush with rotor.
- Place small amount of Loctite # 220 onto capscrews (155), thread fully into rotor holes through sleeve. Torque to 200 inlbf (22.6 Nm).
- Using a hoist, install the disc in the casing with the smooth side of the disc towards the casing (seal cavity outward) and the pressure relief hole 45 degrees downward from the discharge side of the casing. The seal cavity feedback hole should be exposed into inlet area of pump. (SEE FIGURE 9). There exists a 2nd feedback hole in each disc which should be fully covered by the liner near the seal point when properly oriented.

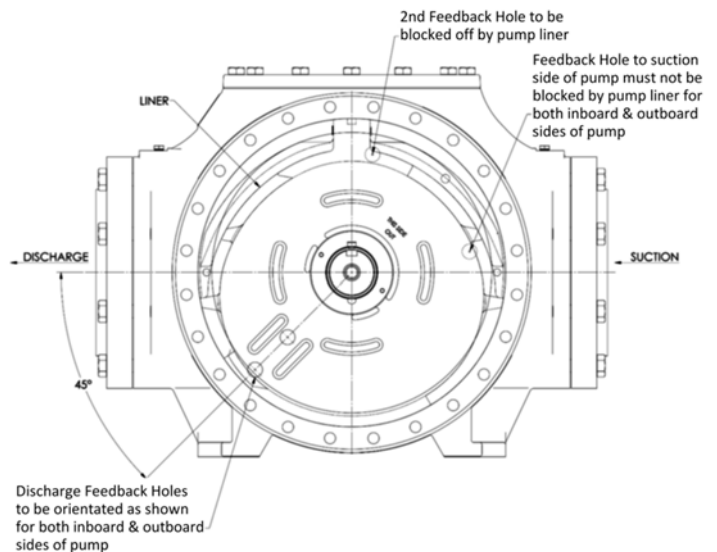

Figure 9 – Disc Orientation

- Install a new head O-ring (72).
- Using a hoist, carefully attach the head (20) to the casing with the head drain hole towards the bottom of the pump. Install and tighten the head capscrews (21).
- Lightly lubricate shaft sleeve surface with bearing grease identified in lubrication section of this manual.
- Install seal rotating assembly minus carbon rotating face onto shaft sleeve. Take care to align mounting holes with corresponding holes on shaft sleeve.

MAINTENANCE

13. Place small amount of Loctite # 220 onto seal mounting capscrews (153J). Install into corresponding threaded holes on seal sleeve. Torque capscrews to 20 inlbf (2.25 Nm).
14. Lightly lubricate inner O-ring (153L) on carbon rotating face using bearing grease identified in this manual. Take care to keep seal face free from grease.

NOTICE:

Use ONLY recommended grease. Using petroleum based grease or oil to lubricate seal O-rings WILL cause seal O-ring damage and subsequent product leakage.

15. Install carbon rotating face and O-ring over shaft while aligning drive notches with drive pins in seal rotating assembly. (see figure 8)
16. Install a new stationary O-ring (153D) in the stationary seat (153B). Clean the polished face with a clean tissue and alcohol. Push the seat fully into the seal recess with the polished face outward.
17. Apply small amount of Loctite #220 to seal retaining screws. Install seal retaining screws and washers (153Q, 153R).
18. If removed, press the grease seal(104A) into the grease seal carrier (104b) with the lips facing toward the bearing. Place the grease seal carrier (104B) with new O-ring (104C) into the hub (20C).
19. Hand pack the ball bearing (24) with grease. Refer to the "Lubrication" section for the recommended grease.
20. Install the bearing into the recess of the hub (20C).
21. Temporarily attach the bearing cover (27) and gasket (26) to hub and hand tighten capscrews (28).
22. Install new hub O-ring (72B) and carefully install the hub assembly (20C) on head. Install and tighten hub capscrews (21A) torquing as indicated in the "Torque Table".
23. Remove the bearing cover and loosely install the bearing locknut and lockwasher (24A, 24B). Snug the locknut on the outboard head to help square the rotor with the head. DO NOT overtighten the nut.
24. Set the pump upright.
25. Remove the outboard head and disc temporarily attached earlier.
26. Complete assembly on the **OUTBOARD** side of the pump as instructed for the inboard side in steps 10-24, leaving the head capscrews loosely tightened.
27. Loosen the bearing locknut on the outboard head and the rotate the shaft to test for binding or tight spots. If the rotor does not turn freely, lightly tap the rims of the heads with a soft faced mallet until the correct position is found. Retighten all head capscrews, torquing to the specifications indicated in the "Torque Table".

MAINTENANCE:

28. LOCKNUT ADJUSTMENT

It is important that the bearing locknuts (24A) and lockwashers (24B) be installed and adjusted properly. Overtightened locknuts can cause bearing failure or a broken lockwasher tang. Loose locknuts will allow the rotor to shift against the discs, causing wear. See Figure 10.

- a. On both ends of the pump shaft, install a lockwasher (24B) with the tangs facing outward, followed by a locknut (24A) with the tapered end inward. Ensure the inner tang "A" of the lockwasher is located in the slot in the shaft threads, bending it slightly, if necessary.

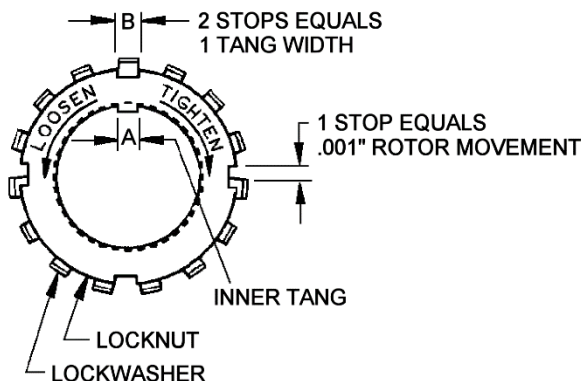
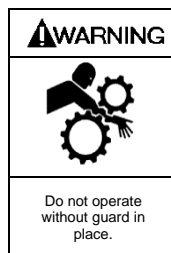

Figure 10 Locknut Adjustment

- b. Tighten both locknuts to ensure that the bearings are bottomed in the head recess. **DO NOT** overtighten and bend or shear the lockwasher inner tang.
 - c. Loosen both locknuts one complete turn.
 - d. Tighten one locknut until a slight rotor drag is felt when turning the shaft by hand.
 - e. Back off the nut the width of one lockwasher tang "B". Secure the nut by bending the closest aligned lockwasher tang into the slot in the locknut. The pump should turn freely when rotated by hand.
 - f. Tighten the opposite locknut by hand until it is snug against the bearing. Then, using a spanner wrench, tighten the nut the width of one lockwasher tang. Tighten just past the desired tang, then back off the nut to align the tang with the locknut slot. Secure the nut by bending the aligned lockwasher tang into the slot in the locknut. The pump should continue to turn freely when rotated by hand.
29. Inspect the grease seal (104) for wear or damage and replace as required. Grease the outside diameter of the grease seal and push it into the inboard bearing cover (27A) with the lip of the seal outward.
 30. Attach a new bearing cover gasket (26) and the inboard bearing cover (27A) to the inboard side of the pump. Install the outboard bearing cover (27) and a new gasket to the outboard side of the pump. Make sure the grease fittings (76) on the bearing covers are accessible. Install and torque the bearing cover capscrews (28) as indicated in the "Torque Table".



Operation without guards in place can cause serious personal injury, major property damage, or death.

31. RELIEF VALVE ASSEMBLY (if equipped)

- a. Insert the valve (9) into the relief valve body(6) with the fluted end inward.
- b. Install the relief valve spring (8), spring guide (7) and guide rod (45) against the valve.
- c. Attach a new relief valve gasket (10) and the valve cover (4) on the cylinder.
- d. Screw the relief valve adjusting screw (2) into the valve cover until it makes contact with the spring guide (7).
- e. Install the relief valve cap (1) and gasket (88) after the relief valve has been precisely adjusted.

NOTICE:

The relief valve setting **MUST** be tested and adjusted more precisely before putting the pump into service. Refer to "Relief Valve Setting and Adjustment"

32. Reinstall coupling, shaft key, and coupling guards.
33. Refer to "Pre-Start Up Check List" and "Start Up Procedures" sections of this manual prior to pump operation.

TROUBLESHOOTING

NOTICE:

Maintenance shall be performed by qualified technicians only, following the appropriate procedures and warnings as presented in this manual.

SYMPTOM	PROBABLE CAUSE
Pump Not Priming	<ol style="list-style-type: none"> 1. Pump not wetted. 2. Worn vanes. 3. Suction valve closed. 4. Internal control valve closed. 5. Strainer clogged. 6. Suction line or valves clogged or too restrictive. 7. Broken drive train. 8. Pump vapor-locked. 9. Pump speed too low for priming. 10. Relief valve partially open, worn or not seating properly. 11. Vanes installed incorrectly (see "Vane Replacement"). 12. Incorrect Rotation
Reduced Capacity	<ol style="list-style-type: none"> 1. Pump speed too low. 2. Suction valves not fully open. 3. Excessive restriction in the suction line (i.e.: undersized piping, too many elbows & fittings, clogged strainer, etc.). 4. Damaged or worn parts (vanes, discs, liner or rotor). 5. Excessive restriction in discharge line causing partial flow through the relief valve. 6. Relief Valve worn, set too low, or not seating properly. 7. External Bypass Valve set too low. 8. Operating without a vapor return line. 9. Vanes installed incorrectly (see "Vane Replacement"). 10. Liner installed backwards.
Noise	<ol style="list-style-type: none"> 1. Excessive pressure drop in suction line due to: <ol style="list-style-type: none"> a. Undersized or restricted fittings in the suction line. b. Pump speed too fast. c. Pump too far from fluid source. 2. Running the pump for extended periods with a closed discharge line. 3. Pump not securely mounted. 4. Misalignment of pump, reducer or motor. 5. Bearings worn or damaged. 6. Vibration from improperly anchored piping. 7. Bent shaft, or drive coupling misaligned. 8. Insufficient oil in the gear reducer. 9. Excessively worn rotor. 10. Malfunctioning valve in the system. 11. Relief valve setting too low. 12. Liner installed backwards. 13. Damaged vanes (see following category).

TROUBLESHOOTING

NOTICE:

Maintenance shall be performed by qualified technicians only, following the appropriate procedures and warnings as presented in this manual.

SYMPTOM	PROBABLE CAUSE
Damaged Vanes	<ol style="list-style-type: none"> 1. Foreign objects entering the pump. 2. Running the pump dry for extended periods of time. 3. Cavitation. 4. Incompatibility with the liquids pumped. 5. Excessive heat. 6. Worn or bent push rods, or worn push rod holes. 7. Hydraulic hammer - pressure spikes. 8. Vanes installed incorrectly (see "Vane Replacement").
Broken Shaft	<ol style="list-style-type: none"> 1. Foreign objects entering the pump. 2. Relief valve not opening. 3. Hydraulic hammer - pressure spikes. 4. Pump/driver, driveline/drive shaft misalignment. 5. Excessively worn vanes or vane slots.
SEAL LEAKAGE	<ol style="list-style-type: none"> 1. O-rings not compatible with the liquids pumped. 2. O-rings nicked, cut or twisted. 3. Shaft at seal area damaged, worn or dirty. 4. Ball bearings overgreased. 5. Excessive cavitation. 6. Mechanical seal faces cracked, scratched, pitted or dirty.
MOTOR OVERLOAD	<ol style="list-style-type: none"> 1. Horsepower of motor not sufficient for application 2. Improper wire size / wiring and/or voltage to motor. 3. Misalignment in pump drive system. 4. Excessive viscosity, pressure or speed. 5. Bearing locknuts adjusted improperly. 6. Faulty or worn bearings. 7. Rotor rubbing against head or cylinder. 8. Dirty mechanical seal faces.

Blackmer[®]

1809 Century Avenue, Grand Rapids, Michigan 49503-1530 U.S.A.
Telephone: (616) 241-1611 • Fax: (616) 241-3752