

Ebsray®

Expert
Solutions
for LPG
Applications

LPG APPLICATIONS
Product Brochure



Where Innovation Flows

REGENERATIVE TURBINE PUMPS
SUBMERSIBLE REGENERATIVE TURBINE PUMPS
BYPASS VALVES

a **DOVER** company

ebsraypumps.com.au

Product-Transfer Solutions for LPG APPLICATIONS

Ebsray® is a Global Leader in the design and manufacturing of Regenerative Turbine Pumps and part of PSG®, a Dover Company. Ebsray's primary focus is on the manufacturing of pumps and pumping equipment – predominantly for process and industrial niche markets.

Ebsray pumps can handle aggressive, toxic, viscous and flammable liquids at high and/or low temperatures. Military, Mining, Food & Beverage, Municipal & Utility Services, Sugar and Paint and Coatings industries are a few of the markets served.

Extensive research and development is a continuing process, to ensure that the products are not only innovative in meeting current and future market needs, but that they also meet or exceed the relevant Statutory Codes and Standards requirements. Safety receives the highest priority in product development, resulting in the quality, reliability and efficiency that will satisfy even the toughest customer expectations and demands in the LPG industry.

Common applications of Ebsray LPG pumps include:

- Autogas - aboveground pumps/aboveground tanks
- Autogas - aboveground pumps/underground tanks
- Autogas - submersible pumps/underground or aboveground tanks
- LPG Tankers - for bobtail or transport use
- LPG Bulk Transfer - fixed installations, terminals/ depots load-in/load-out
- Cylinder filling - forklifts, carousels, etc.
- Aerosols-filling, transfer, etc.

Pump principles utilized in Ebsray's range of LPG pumps include:

- Regenerative turbine for quiet operation under even the most challenging suction conditions
- Sliding vane positive displacement pumps for higher flow rates and bulk transfer

Ancillary equipment and services available from Ebsray include:

- Ebsray bypass valves for return-to-tank LPG operation, simple in design and exhibiting distinct operational advantages relating mainly to noise and vibration elimination
- Complete built-up LPG pumpsets with electric motors, diesel engines, hydraulic drives, etc.
- Electronic-control equipment for LPG submersible pump and LPG system protection
- Technical advice for autogas service station system design and LPG pump installation
- Repair/service facilities
- After-sales technical support network worldwide

Currently, Ebsray is successfully expanding its distributor network worldwide into areas including Europe, Southeast Asia, Middle East, South America, Africa and the Pacific region – in addition to its established domestic Australian market. They continue to supply their quality LPG pumps and equipment to most major LPG suppliers, retailers, carriers and end-users.

Ebsray is committed worldwide to the LPG Industry in the supply of well-engineered, innovative and reliable Australian-manufactured LPG pumps and related LPG pumping equipment.



Ebsray®

The Specialist for Your AUTOGAS Needs

The autogas market is growing and Ebsray is meeting the challenge by providing precision-built, efficient, high-pressure pumping solutions.

Ebsray pumps are versatile to be used in similar applications of cylinder filling, vaporizer feeding and bulk transfer. Ebsray offers a cost effective solution for all autogas applications. We offer customization to your specifications.

Ebsray Versatility and Support

- Designed for underground and aboveground tank applications
- Ideal for dual hose dispensers and multiple dispensers
- Simple installation, rigid mounting
- All systems offer the Ebsray "Three-tier" protection system for pump, motor and pumping system
- Electronic-control equipment for LPG submersible pump and LPG system protection
- Technical advice for autogas service station system design and LPG pump installation
- Repair/service facilities
- After-sales technical support network worldwide

Long Life and Ease of Maintenance

Our autogas pumps and accessories are designed with a rugged ductile iron construction for long-lasting life. The pumps feature:

- Quiet, smooth, pulse-free operation
- Throttle bush for increased safety
- High differential-pressure capability
- Flanged porting for simple installation and safe operation
- Balanced mechanical seal and precision lapped faces for excellent service life

Typical Aboveground Tank Installation

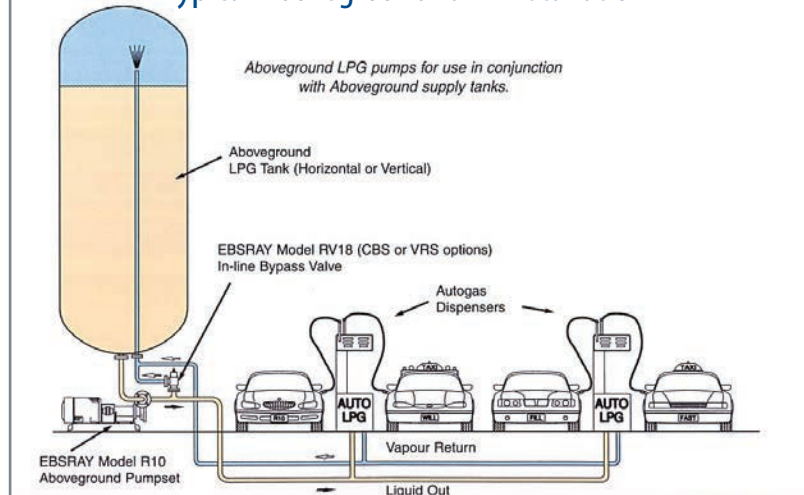

Lift On Underground Tank Installation

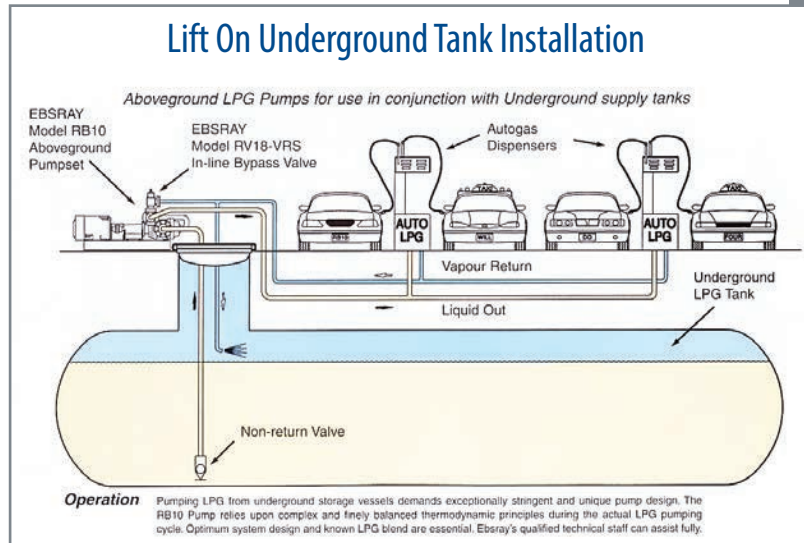

Submersible On Underground Tank Installation

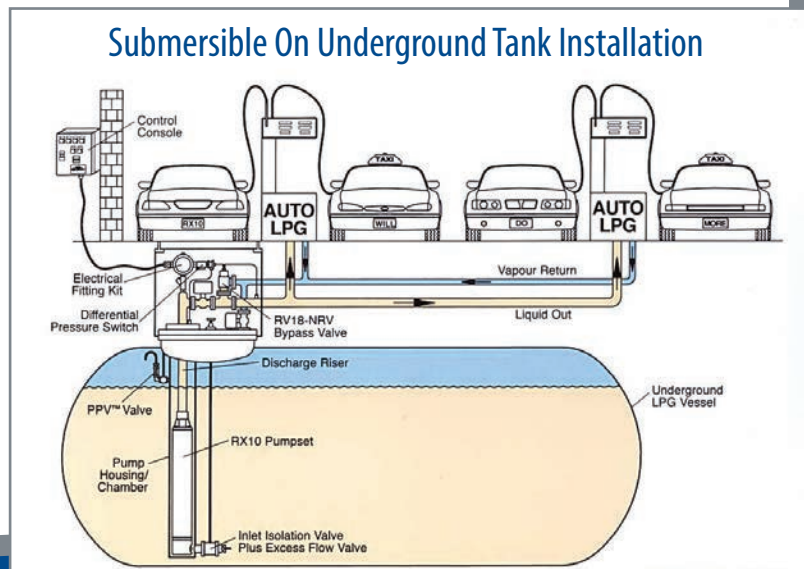

TECHNOLOGY: REGENERATIVE TURBINE

R Series: Model R10

Regenerative Turbine Pumps

The Ebsray Model R10 Regenerative Turbine Pump is designed and precision-built for high-flow, high-pressure transfer of LPG, autogas, propane, butane, DME and anhydrous ammonia.

Applications

- Driveway dispensing, up to 6 hoses
- Industrial dispensing
- Bulk filling
- Vehicle filling
- Aerosol industries
- Marine dispensing
- Portable tanks
- Agricultural industries
- Cylinder filling
- Forklift refueling
- Direct burner or vaporizer feed

Features & Benefits

- Quiet operation
- Direct coupled to 2,880-rpm or 3,500-rpm motors
- Other drive options: Vee belt, engine or PTO
- Low maintenance, single stage impeller
- Flanged porting for simple installation and safe operation
- Balanced mechanical seal and precision lapped faces for excellent service life
- Throttle bush for increased safety

Technical Data

Materials:

- Pressure casings - Ductile iron to ASTM A395
- Impeller - Bronze, optional ductile iron

Porting:

- Inlet: Flanged DN 38 1-1/2 in. Class 300 ANSI
- Discharge: Flanged DN 25 1in. Class 300 ANSI

Performance Data

- Max. flows: 140 L/min (37 gpm)
- Max. differential pressure: 11 bar (160 psi)
- Hydrostatic test pressure: 70 bar (1016 psi)

Certifications & Associations:



R Series: Model R10
Regenerative Turbine Pump

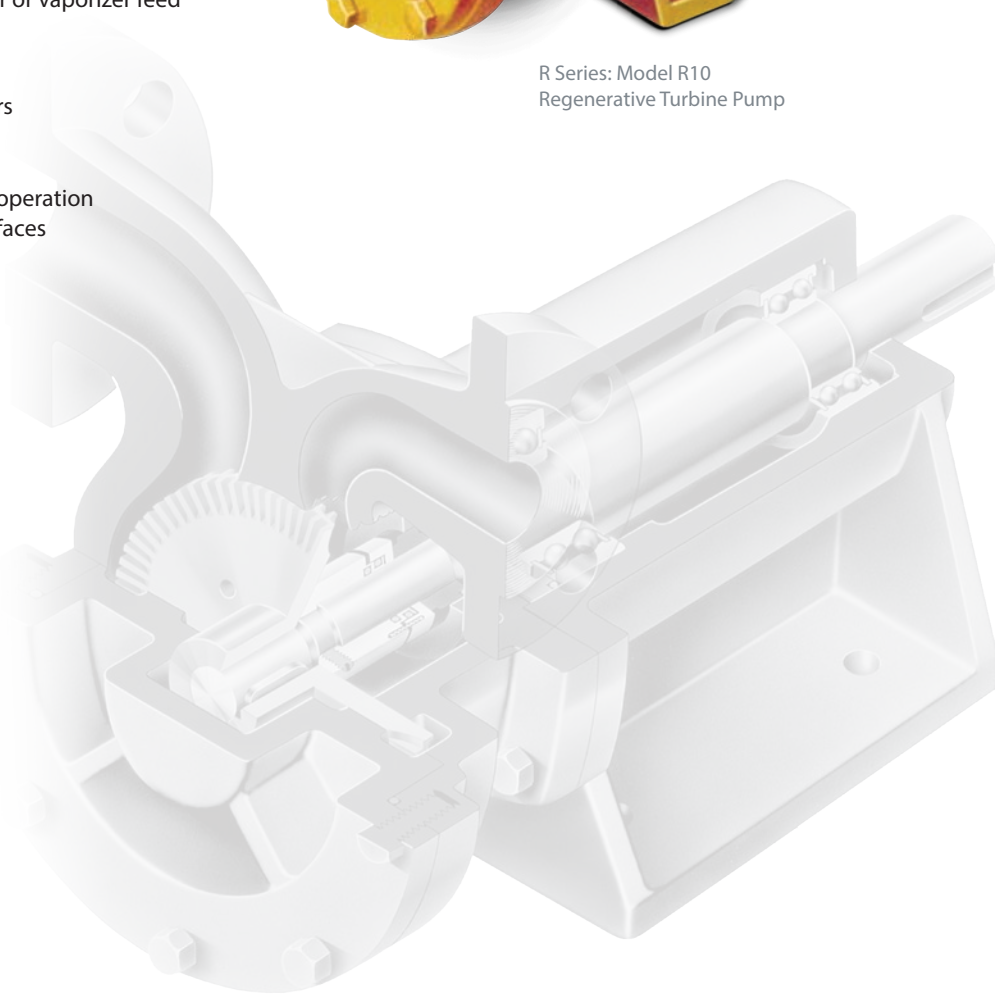



TECHNOLOGY: REGENERATIVE TURBINE

R Series: Model RC20 & RC25

Regenerative Turbine Pumps

The Ebsray Model RC Series Regenerative Turbine Pumps are designed and precision-built for high-pressure transfer of LPG, autogas, propane, butane, DME and anhydrous ammonia.

Applications

- Driveway dispensing, up to 2 hoses (RC25)
- Industrial dispensing
- Autogas refueling
- Aerosol industries
- Marine dispensing
- Portable tanks
- Cylinder filling
- Forklift refueling
- Direct burner or vaporizer feed

Features & Benefits

- Quiet, vibration-free operation
- Low maintenance, single-stage impeller
- Close coupled to standard IEC frame B5 Flange mounted 2-pole motors-EExe or EExd protection, 2,880 rpm or 3,500 rpm
- Simple installation, rigid mounting
- Versatile 3-port arrangement, self-venting design
- Bypass valve connection port direct on pump
- Balanced mechanical seal, unique cartridge design for simplicity of assembly/maintenance
- Throttle bush for increased safety

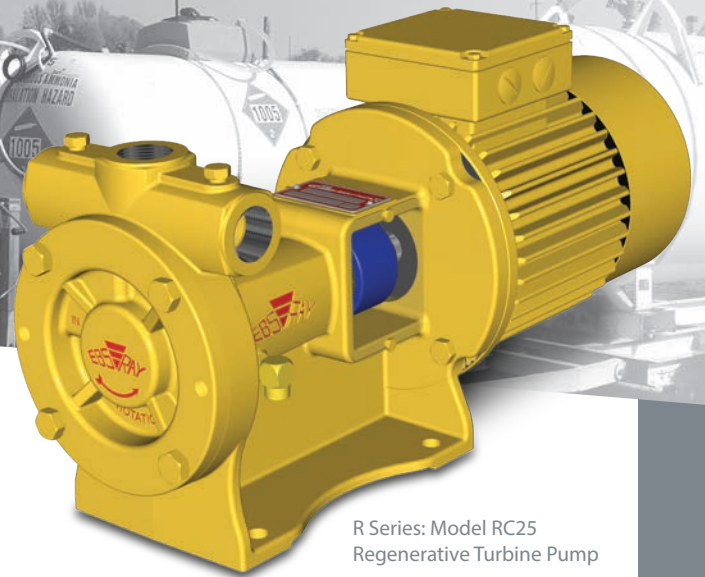

R Series: Model RC25
Regenerative Turbine Pump

Technical Data

Materials:

- Pressure casings - Ductile iron to ASTM A395
- Impeller - Bronze, ductile iron optional

Porting:

- Inlet: DN 25/1 in. NPT(F)
- Discharge: DN 25/1 in. NPT(F)

Performance Data

- Max. flows: RC20: 50 L/min (13.21 gpm)
RC25: 90 L/min (23.78 gpm)
- Max. differential pressure: 10 bar (145 psi)
- Hydrostatic test pressure: 70 bar (1,016 psi)

Certifications & Associations:



TECHNOLOGY: REGENERATIVE TURBINE

R Series: Model RB10

Regenerative Turbine Pumps

The Ebsray Model RB10 Regenerative Turbine Pump is designed and precision-built for high-flow, high-pressure transfer of LPG, autogas, propane, butane, DME—mainly from underground or semi-buried storage tanks.

Applications

- Driveway dispensing, up to 6 hoses
- Autogas applications
- Bulk filling
- Agricultural industries
- Aerosol industries
- Marine dispensing
- Cylinder filling
- Forklift refueling
- Direct burner or vaporizer feed

R Series: Model RB10
Regenerative
Turbine Pump

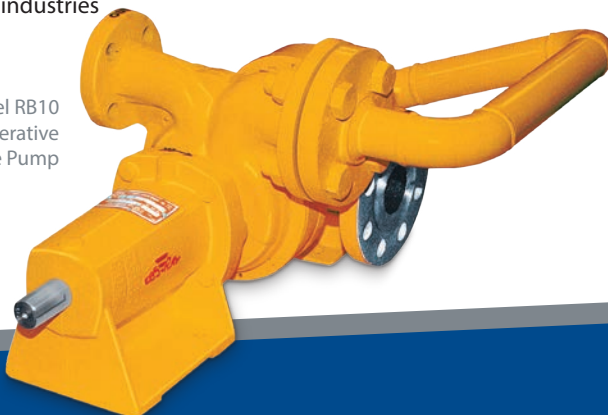

Features & Benefits

- Quiet, vibration-free operation
- Direct coupled to 2,880-rpm or 3,500-rpm motors
- Other drive options: Vee belt, engine or PTO
- Low maintenance
- Flanged porting for simple installation and safe operation
- Balanced mechanical seal and precision lapped faces for excellent service life
- Throttle bush for increased safety
- Low NPSH booster first-stage impeller

Technical Data

Materials:

- Pressure casings - Ductile iron to ASTM A395

Porting:

- Inlet: Flanged DN 50 (2 in.) ANSI Class 300
- Outlet: Flanged DN 25 (1 in.) ANSI Class 300

Performance Data

- Max. flows: 140 L/min (37 gpm)
- Max. differential pressure: 11 bar (160 psi)
- Hydrostatic test pressure: 70 bar (1,016 psi)

Certifications & Associations:



TECHNOLOGY: REGENERATIVE TURBINE

R Series: Model RX10 & Model RX33

Submersible Regenerative Turbine Pumps

The Ebsray Model RX33 Regenerative Turbine Pumps are specifically designed and precision-built for efficient high-pressure pumping of LPG, autogas, propane and butane from underground or aboveground storage tanks.

Applications

- Autogas driveway dispensing for up to 4-6 hoses, site and usage dependent
- Forklift refueling
- Aerosol industries
- Agricultural industries
- Marine dispensing
- Cylinder filling
- Direct burner or vaporizer feed

Features & Benefits

- Single-stage regenerative turbine pumping element
- Quiet, smooth, pulse-free operation
- Submersible concept guarantees rapid priming and pressure generation
- Internal BCL™ "Bearing Cooling and Lubrication" system for ultimate pump reliability
- Ebsray "Three-tier" protection system for pump, motor and pumping system
- High differential-pressure capability

MODEL RX10: ATEX/ANZEx certified explosion-proof design submersible electric motor

MODEL RX33: IECEx/ATEX certified explosion-proof design submersible electric motor

RX10 Technical Data

Materials:

- Ductile iron to ASTM A395/steel casing
- Impeller - Bronze

Porting:

Inlet: DN 50 (2 in.) nominal
Discharge: DN 50 (2 in.) NPT(F)

RX10 Performance Data

- Max. flows: 103 L/min (27.21 gpm)
- Max. differential pressure: 9 bar (130 psi)

RX33 Technical Data

Materials:

- Ductile iron to ASTM A395

Porting:

Inlet: DN 38 (1-1/2 in.) nominal
Discharge: DN 38 (1-1/2 in.) NPT(F)

RX33 Performance Data

- Max. flows: 55 L/min (14.53 gpm)
- Max. differential pressure: 8.6 bar (125 psi)

Certifications & Associations:



R Series: Model RX33
Submersible Regenerative
Turbine Pump

R Series: Model RX10
Submersible Regenerative
Turbine Pump

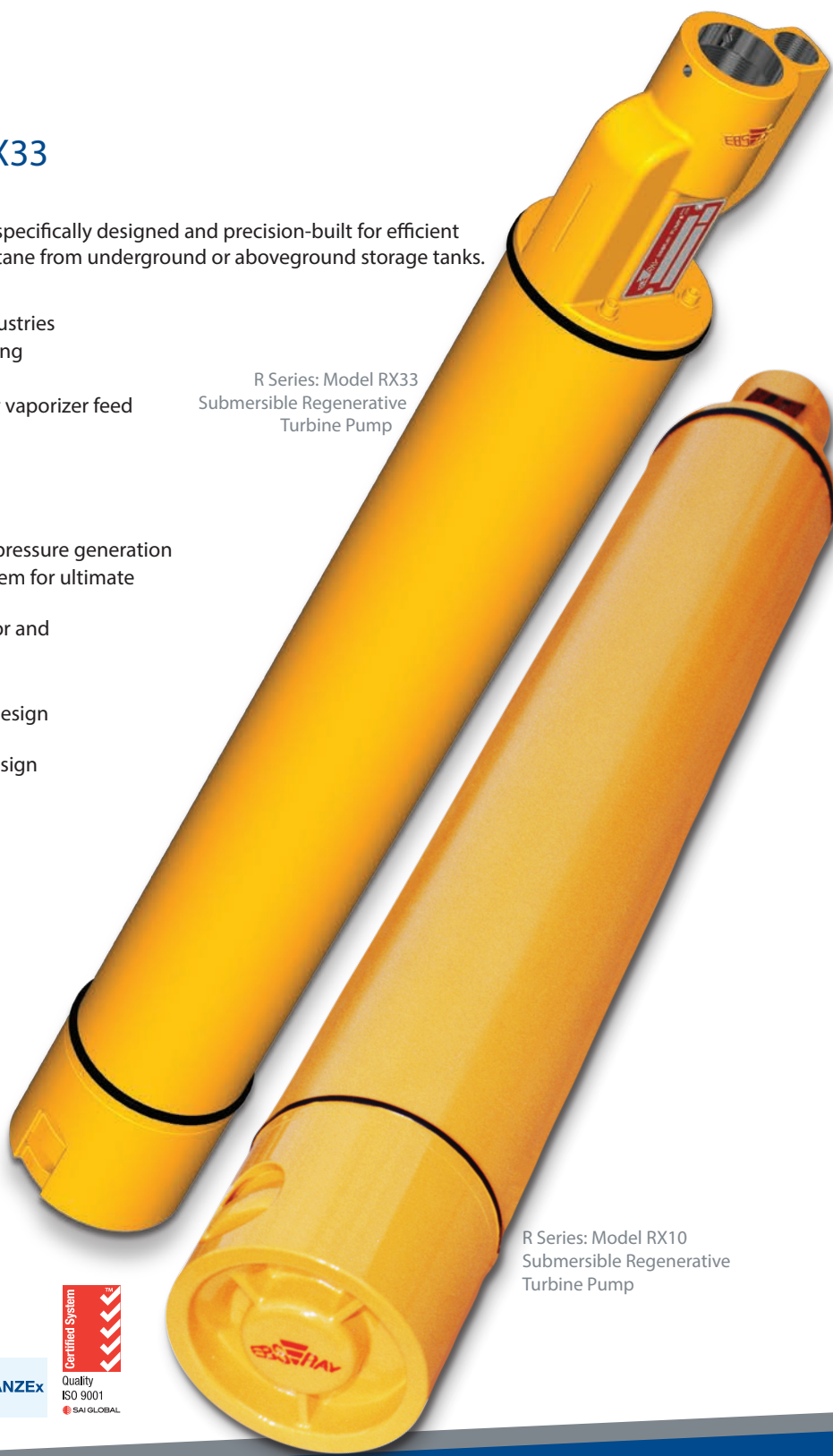

TECHNOLOGY: REGENERATIVE TURBINE

RV Series: Models RV18 & RV19

Bypass/Pressure Relief Valve

The Ebsray Bypass/Pressure Relief Valves are specifically designed for a wide variety of industrial services. The easily adjustable differential-pressure settings provide accurate and repeatable performance that enables full pump flow while maintaining controlled preset maximum pressure.

Applications

- Autogas driveway dispensing
- Forklift refueling
- Aerosol industries
- Agricultural industries
- Marine dispensing
- Cylinder filling
- Direct burner or vaporizer feed

Features & Benefits

- 90° porting arrangement
- Flanged ANSI Class 300 or threaded (NPT) ports available for most models
- Adjustable pressure setting within spring range for optimum dispensing flow rates
- Low pressure rise

Optional valve types-application dependent:

- CBS - Constant Bleed System
- VRS - Vapour Removal System
- NRV - Non-Return Valve (refer Ebsray for details)

Technical Data

Materials:

- Pressure Casings: Ductile iron to ASTM A395
- Elastomers - FKM – as standard
- Special materials to specification

Porting:

RV18: DN 25/1 in. flanged ANSI 300 screwed NPT(F)
RV19: DN 38/1-1/2 in. flanged ANSI 300 screwed NPT(F)

Performance Data

- Max. flows:
RV18: 200 L/min (52.83 gpm)
RV19: 600 L/min (158.5 gpm)
- Diff. pressures to 14 bar (200 psi)
- Hydrostatic test pressure: 70 bar (1,016 psi)

Certifications & Associations:



Quality
ISO 9001
SAI GLOBAL

RV Series: Model RV18
In-line Bypass/Pressure
Relief Valve



Autogas

Ebsray[®]

EBSRAY PUMPS PTY LIMITED
ABN 52 000 061 003

Head Office and Works
156 South Creek Road,
Cromer NSW 2099, Australia

T: (+61 2) 9905 0234 F: (+61 2) 9938 3825
ebsraypumps.com.au

Where Innovation Flows



PSG[®] reserves the right to modify the information and illustrations contained in this document without prior notice. This is a non-contractual document. 11-2018

Authorized PSG Partner: