

# EBSRAY PUMPS

## INSTALLATION, OPERATION & MAINTENANCE INSTRUCTIONS

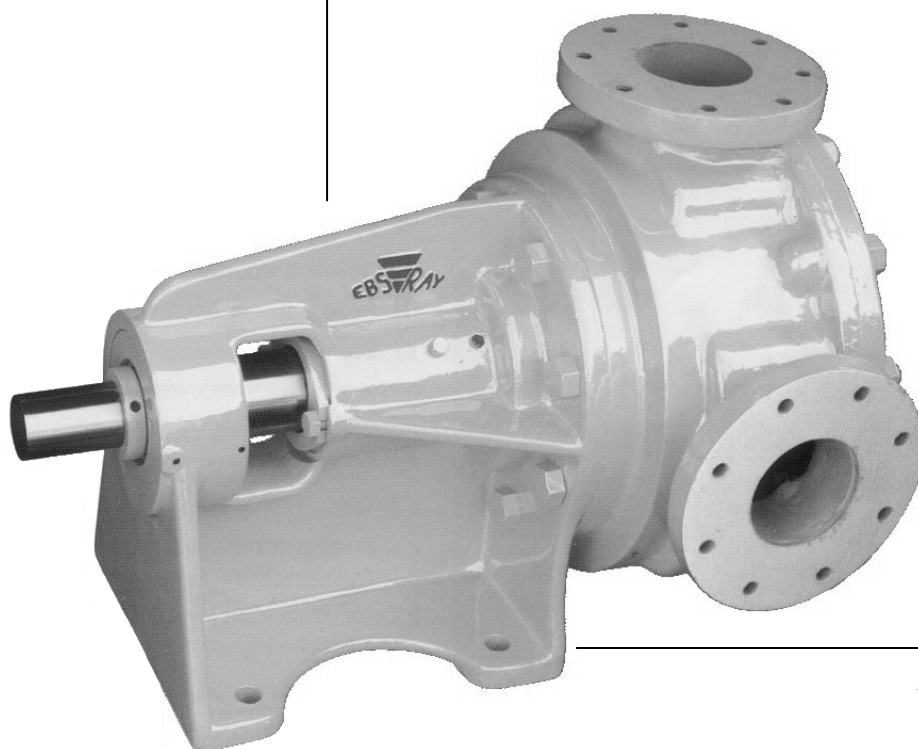

### ***HD SERIES Std Bracket MODEL HD300 & HD400***



Quality  
Endorsed  
Company  
ISO 9001 Lic 3332  
SAI Global



# SECTION 1 - GENERAL

## INTRODUCTION

This leaflet is intended to assist those involved with the installation, operation and maintenance of EBSRAY Model HD300 & HD400 Std Bracket Internal Gear Positive Displacement Pumps. The design, materials and workmanship incorporated in the manufacture of EBSRAY pumps make them capable of reliable operation over a long working life. Correct installation is essential. Service life is enhanced by periodic inspection and careful maintenance.

### 1.1 CAUTION

**INSTALLATION AND SERVICING OF THIS EQUIPMENT SHOULD BE PERFORMED BY QUALIFIED COMPETENT PERSONNEL IN ACCORDANCE WITH RELEVANT STATUTORY REGULATIONS OR CODES, IN CONJUNCTION WITH THESE INSTRUCTIONS.**

When the equipment supplied utilises components other than those manufactured by EBSRAY e.g. couplings, speed reducers, electric motors etc, reference should be made to the original manufacturer's data before installation or servicing is commenced. Failure to observe these details may void the warranty.

### 1.2 WARNING

***The pump must be operated within the original selected design parameters of speed, temperature, pressure and viscosity. Should any change be contemplated, please confer with EBSRAY in order to verify the suitability of such a change.***

### 1.3 TRANSPORTATION AND PACKING

Standard domestic packing is suitable for shipment in covered transports. Ports must be sealed to exclude ingress of solids. When received on site the pump should be stored in a dry covered area.

If storage is required for other than a short period prior to installation, special preservatives and protective wrappings will be required. Refer to EBSRAY for details.

### 1.4 INSPECTION ON RECEIPT - SHORTAGES

On receipt of equipment, check all items against the dispatch documents and inspect for damage. Any damage or shortage incurred during transit should be noted on the packing note and on both your own and the carrier's copy of the consignment note and a claim should be made immediately on the transport company.

Should a shortage be evident on receipt, notify EBSRAY immediately giving full details and packing note number.

### 1.5 HANDLING

***Do not drop pump/pumpset*** Care should be taken in moving/handling pumps/pumpsets. A sling should be placed under or around a pump/pumpset in order to minimise stress on the internal components.

The pump/pumpset should be lifted in such a manner as to ensure compliance with the relevant lifting codes.

***Severe internal damage may result if correct handling and due care is not taken.***

# SECTION 2 - INSTALLATION

## CAUTION

**INSTALLATION AND REMOVAL OF THIS EQUIPMENT SHOULD BE PERFORMED BY QUALIFIED COMPETENT PERSONNEL IN ACCORDANCE WITH RELEVANT STANDARDS, CODES, REGULATIONS AND SITE RESTRICTIONS - IN CONJUNCTION WITH THESE INSTRUCTIONS.**

## DANGER

**NEVER LOOSEN OR REMOVE FITTINGS, FLANGES, ETC. WHILE UNDER PRESSURE, ALWAYS ISOLATE COMPONENTS OR PIPEWORK AND DEPRESSURISE PRIOR TO WORK.**

### 2.1 LOCATION

The pumpset should be placed as close as practicable to the source of supply, keep within the NPSH requirement of the pump. Ensure floor area and headroom allotted is sufficient for inspection and maintenance. Allow sufficient space and ventilation for motor cooling requirements. Allow for crane or hoist access if required.

### 2.2 FOUNDATIONS

Baseplate mounted Pumpsets should be accurately installed. When on a concrete foundation ensure that it has been poured on a solid footing. NOTE: Position foundation bolts to match baseplate foundation plan. Pumpsets must be securely bolted down.

### 2.3 PUMP PIPING CONNECTIONS

All piping should be supported independently of and line up accurately with the pump ports.

**SEVERE DAMAGE COULD RESULT IF PIPING IS DRAWN INTO PLACE BY USE OF FORCE AT THE PORT CONNECTIONS OF THE PUMP.**

### 2.4 STRAINER PROTECTION

The pump inlet should always be protected by an efficient strainer of adequate size to accommodate the liquid viscosity conditions and within NPSH<sub>R</sub> by the pump

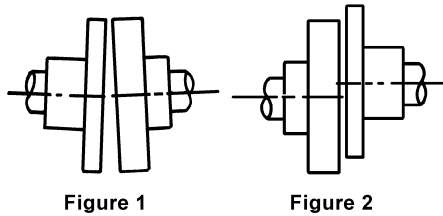

Figure 1

Figure 2

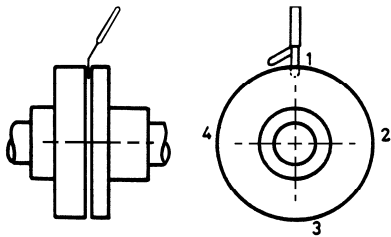

Figure 3

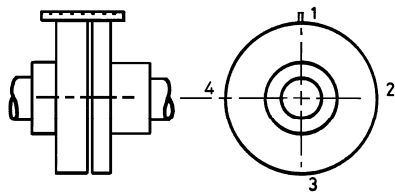

Figure 4

## 2.5 ALIGNMENT

Alignment of the pump and driver is of extreme importance for trouble-free mechanical operation. EBSRAY mounted pumpsets are accurately aligned at the factory. To ensure this has been maintained during transit, alignment **MUST BE** checked once before startup and again after the pumpset has been run under actual operating conditions. NOTE: The following procedures are typical only and reference should be made to data for specific coupling types.

ANGULAR MISALIGNMENT as shown in Fig.1 should be corrected before eccentricity. Refer Fig.3; Use feeler gauge reading at 90° intervals, the amount of correction necessary can be easily determined to bring shaft axes in line.

Misalignment due to ECCENTRICITY as shown in Fig.2 can now be corrected. Refer Fig.4; adjustment by use of shims under the driver or pump will effectively correct error in the vertical plane. Movement of Pump or Driver horizontally will correct error in the horizontal plane. NOTE: If both coupling halves are of identical diameter, concentricity may be checked with a straight edge at 90° intervals.

## SECTION 3 - OPERATION

### 3.1 DESCRIPTION

The EBSRAY Internal Gear principle is based upon the use of an Outer Rotor 'A', idler gear, termed Inner Rotor 'B' and a crescent shaped spacer 'C' which is cast integral with the Cover. Thus only two moving parts fulfill this efficient displacement cycle. Power is applied to the Outer Rotor 'A' and transmitted to the meshing idler or Inner Rotor 'B'. The rotor teeth cells which are not involved in the meshing cycle are sealed by the crescent 'C', Body and Cover. (Refer Fig.5)

### 3.2 PUMPING PRINCIPLE

When rotation is started there is an increase in cell volume as the teeth come out of mesh. This creates a partial vacuum and the pressure differential thus created initiates movement of the liquid through the inlet port 'D', filling the teeth cells of the two displacement rotors. When the tooth meshing withdrawal cycle is complete and the tooth cell volume is filled with liquid, transfer to the pressure or discharge side is effected as the liquid is carried past the crescent sealing member 'C'. This sealing crescent establishes a labyrinth between the high and low pressure sides, minimising fluid slip. When the teeth mesh on the pressure side, the liquid is forced from the teeth cells and flows through the discharge port 'E'.

A noteworthy feature of this simple pump principle is the absence of high tooth contact pressures when compared with conventional gear pumps, many of which employ costly external timing gears to minimise tooth wear. The Inner Rotor 'B', or idler remains in almost hydraulic balance requiring only minimal torsional load to effectively follow the driving Outer Rotor.

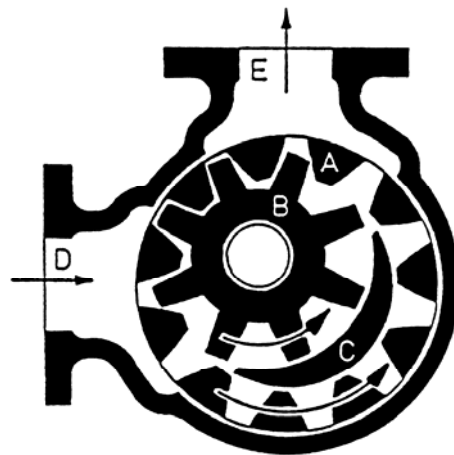

Figure 5

### 3.3 APPLICATIONS

The field of applications for Internal Gear rotary positive displacement pumps is extensive. These pumps are used to handle many kinds of liquids over a wide range of capacities and pressures, associated with viscous or non-viscous, hot or cold and corrosive or non-corrosive conditions. Accordingly material, speed and power specifications vary and it is important to use such equipment strictly adhering to the manufacturers' recommendations.

### 3.4 LUBRICATION

Lubrication of the Inner Rotor bearing and Bracket Bearing (both are sleeve bearings) is dependent on the pumpages' lubricating qualities/material selection of the bearing.

The Ball Bearing is lubricated at the time of assembly with a high quality lithium base grease. Replacement of this grease is normally only necessary when major maintenance is carried out.

### 3.5 STARTUP CHECKLIST

- Lubricate as required.
- Alignment of couplings.
- Direction of rotation.
- Freedom of rotation of shaft.
- Inlet and discharge valves open
- Product available for pumping
- Special precautions as required

Do not start pump against closed discharge valve or with inlet (suction) valve throttled. Ensure bypass valve (if fitted) is operational and set to the correct pressure.

***Do not exceed system or pump design pressure as equipment failure could result. Do not run pump dry. Failure to remove air/vapour could prevent pump from priming and result in pump damage.***

### 3.6 OPERATIONAL CHECKS

Inspect pump frequently during the first few hours of operation for such conditions as excessive heating of bearings or stuffing box, vibration, unusual noises etc.

### 3.7 BYPASS VALVE

To protect the pump from overpressure due to inadvertent shutting of discharge system, EBSRAY can supply integral or inline Bypass Valves which are capable of circulating the entire pump output. The integral type Bypass Valve is mounted on the pump Cover and bypasses pumpage from the pressure side to the inlet side of the pump.

The inline type Bypass Valve is installed in the pump discharge line and normally returns to the inlet side of the pump or back to tank. Fluid temperature will rise if differential pressure is high and recirculating bypass conditions are maintained for extended periods (particularly with integral Bypass Valve). The Bypass Valve should be set on site, in accordance with the predetermined pump and/or system differential pressure required. Refer separate instructions.

## SECTION 4 - MAINTENANCE

### **CAUTION:**

***PRIOR TO ANY DISASSEMBLY OR SERVICE, VERIFY THAT ALL REQUIREMENTS OF STATUTORY REGULATIONS OR CODES ARE MET AND THAT SPECIFIC SITE REQUIREMENTS ETC ARE SATISFIED.***

Some minor maintenance tasks and inspections can be performed with the pump 'in line' so long as complete isolation, depressurising and purging procedures have been completed. However for major maintenance it is recommended that the pump be removed from the installation.

### 4.1 SPARE PARTS

1. When ordering spare parts, to ensure a minimum of delay and correct replacement to original specification ALWAYS quote the pump Serial Number which is located on the nameplate of the pump.
2. Advise the name, item number and quantity required. (Refer to Drawings – Section 7)
3. Advise complete delivery instructions.

### 4.2 PREPARATION FOR DISASSEMBLY

1. Obtain the appropriate Work Permit if required.
2. Isolate pump from liquids in inlet and discharge lines, depressurise and purge out any toxic, flammable, corrosive or air hardening liquids.

3. Isolate power supply to motor.
4. Disconnect porting connections.
5. Remove pump from installation.
6. Mark relevant mating components for correct reassembly orientation.

### 4.3 DISASSEMBLY

Note: Before proceeding, make sure Bracket is firmly attached to baseplate or bench etc. to avoid overbalancing when rotor is withdrawn. Mark relevant mating components to ensure correct replacement.

1. Remove pump coupling half.
2. Remove Bypass Valve assembly from Cover.
3. Remove Lockscrews on both Lockrings.
4. Release Grubscrews, unscrew Locknut from Shaft.
5. Remove Outer Lock Ring.
6. Remove lubrication/cooling circulation harness assemblies if fitted.

.....**For pumps fitted with EBSRAY Mechanical Seals:**

7. Release Mechanical Seal Plate evenly to avoid damage.
8. Remove access plug and rotate Shaft until Drivescrew is accessible, loosen Drivescrew 2 full turns to clear circlip groove.
9. To facilitate removal of Cover, tapped extraction holes are fitted. Remove Cover assembly complete with Inner Rotor. Care should be taken to prevent Inner Rotor sliding off Inner Rotor Pin.
10. The Rotor/Shaft assembly can now be driven through the pump from the drive end taking care to adequately support the Rotor end.
11. Remove Inner Race Lockring, Bracket Ball Bearing, Bearing Spacer and Bearing Sleeve.
12. Remove Mechanical Seal components taking care to avoid damage to lapped faces (Remove Extraction Washer if fitted with non-metallic Bearings).
13. Disassemble Cover assembly if required.
14. Remove Body from Bracket if required.
15. Press out Inner Rotor Bearing and Rotor Bearing if replacement is required.

.....**For pumps fitted with packed glands:**

Standard packed glands require correct grade packing for duty. A Lantern Ring is fitted adjacent to the Rotor Bearing for suction return and relief of packing pressure.

7. Release Glandplate.
8. To facilitate removal of Cover, tapped extraction holes are fitted. Remove Cover assembly complete with Inner Rotor. Care should be taken to prevent Inner Rotor sliding off Inner Rotor Pin.
9. The Rotor/Shaft assembly can now be driven through the pump from the drive end taking care to adequately support the Rotor end.
10. Remove Inner Race Lockring, Bracket Ball Bearing, Bearing Spacer and Bearing Sleeve.
11. Using a suitable tool, remove Packing and Lantern ring.
12. Disassemble Cover assembly if required.
13. Remove Body from Bracket if required.
14. Press out Inner Rotor Bearing and Rotor Bearing if replacement is required.

#### **4.4 INSPECTION**

Inspect components for damage or excessive wear. Note that typical wear of components in EBSRAY's rotary Internal Gear positive displacement pumps tend to compensate each other and working clearances are to some extent maintained by this compensation. If pump performance has been satisfactory, existing components although worn, may still have adequate service life and could be used provided any burrs or sharp edges are removed prior to reassembly. Major refurbishing of the pump should be done in line with reconditioning to an 'as new' status as replacing or repairing one component may have an effect on other components and the working clearances of the pump.

#### **4.5 REASSEMBLY- PRELIMINARY**

1. Ensure all parts are clean before assembly. Remove any burrs.
2. Ensure free running fit of Inner and Outer Lockrings in Bracket.
3. Fit lip seals to Inner and Outer Lockrings, positioning sealing lip *towards* Bearing.
4. If replacing Bracket Bearing:
  - a) Metallic: Press-fit, ensuring lubrication groove in Bearing is in the 12 'O'clock position. If the Bracket has a greaser hole, align lubrication groove with the greaser hole and drill through after fitting Bearing.
  - b) Carbon: The recommended method of fitting carbon Bearings is shrink-fitting. Press-fitting carbon Bearings may cause damage to the Bearing. Fit Bearing flush with spigot face, ensuring lubrication groove in Bearing is in the 12 'O'clock position. Machine or ream to achieve correct clearance on Shaft ensuring squareness and concentricity with locating spigot.
5. If replacing Inner Rotor Bearing:
  - a) Metallic: Press-fit with Bearing flush with one side of Inner Rotor.
  - b) Carbon: Shrink fit. (See 4b).

Machine or ream to achieve required clearance on Inner Rotor Pin ensuring squareness and concentricity with Inner Rotor O.D.

**Table of Clearances HD300 & HD400** – All clearances in millimetres

	Running Clearances	Metallic		Carbon		
		'A' CLEARANCE	'B' CLEARANCE	'A' CLEARANCE	'B' CLEARANCE	
W	Diametral - Shaft to Bearing	0.101 - 0.139	0.127 - 0.165	0.076 – 0.114	0.101 – 0.139	
Z	Diametral - Rotor Pin to Bearing	0.127 - 0.165	0.127 - 0.165	0.089 – 0.127	0.089 – 0.127	
Y	Axial - Rotors to Cover	0.10 - 0.15	0.14 – 0.19	0.10 - 0.15	0.14 – 0.19	
X	Diametral - Outer Rotor to Body	HD300	0.20 - 0.30	0.33 - 0.44	0.20 - 0.30	0.33 - 0.44
		HD400	0.25 – 0.35	0.38 – 0.50	0.25 – 0.35	0.38 – 0.50
V	Radial - Inner Rotor to Crescent	0.03 - 0.08	0.03 - 0.08	0.02 - 0.06	0.02 - 0.06	

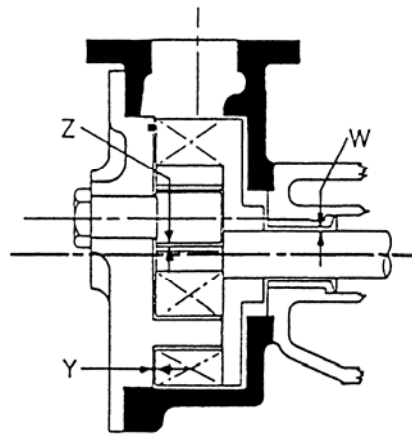
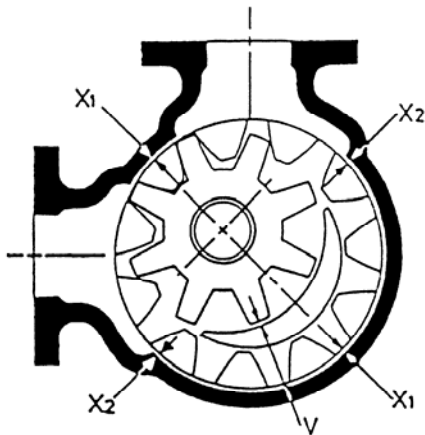

6. Carry out preliminary sizing checks:

- a) Axial length of Inner Rotor, Outer Rotor teeth and Cover crescent must be matched to within +/- 0,02mm.
- b) Outer Rotor in Body diametral clearance. Note: If checking by feeler gauge method, allowance or compensation must be made for eccentricity caused by:
  - i) Weight of Rotor.
  - ii) Clearances between Shaft and Bracket Bearing.
  - iii) Lack of Bearing support at drive end

To measure clearance, insert feeler gauge at two opposite measurement points 'X1'. Add the two clearances together. This will give the diametral clearance 'X' for the two points. Repeat this procedure for the other two measurement points 'X2'.

c) To check clearance between Inner Rotor and Cover crescent, Inner Rotor should be held towards inlet plane. Refer Fig. 7

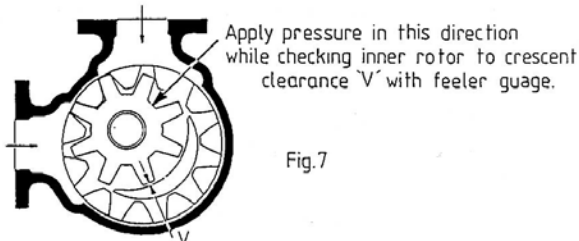

7. Ensure all lubrication/cooling circulation harness assemblies are clear of any obstructions.
8. EBSRAY recommend replacement of all Gaskets, Seals and O-Rings at every overhaul, to ensure positive sealing.

**4.6 REASSEMBLY** (Refer Drawing – Section 7)

During reassembly, lubrication is required in some areas. All lubrication in areas where it may come into contact with pumped product should be with a product compatible lubricant. The Bracket Ball Bearing and lockring Seals may be lubricated with any high quality lithium base grease suitable for the operating conditions.

1. (For pumps fitted with Cover Plate only)  
Using a new Cover Gasket, locate the Cover Plate on the Cover with the Inner Rotor Pin bores in alignment and temporarily fasten the two together using bolts of the same diameter as the Cover bolts. After fastening Inner Rotor Pin (Step 4) remove these temporary bolts.
2. Fit Inner Rotor Pin Sealing Washer (if fitted) to the Inner Rotor Pin locating step.
3. Apply a suitable sealant (e.g. Loctite) to the Inner Rotor Pin bore in the cover. Ensure sealant does not enter the Inner Rotor. Press Inner Rotor Pin into Cover ensuring lubrication groove points centrally towards crescent and adequate support is given around the Inner Rotor Pin bore boss when pressure is applied.

4. Place Inner Rotor Pin Spacer (if fitted) and Inner Rotor Pin Washer over Inner Rotor Pin and lock Inner Rotor Pin Nut securely whilst maintaining lubrication groove location. Note: Use of a split clamp will aid this operation.
5. Fit Body to Bracket with Gasket between faces. Maintain correct inlet and discharge port orientation, securely tighten in a uniform manner.
6. Insert Rotor/Shaft assembly ensuring Rotor Bearing is lubricated.
7. Fit Inner Rotor over Inner Rotor Pin in Cover assembly with flush side towards Cover, ensure Inner Rotor Pin Bearing is lubricated.
8. Fit Cover assembly to Body with Gasket between faces, make sure the seal land of the Cover matches with the seal land in the pump Body. (This seal land is diametrically opposite the centre of the Cover crescent). Lubricate pump elements through pump port and check that Rotor/Shaft assembly turns freely.

.....**For pumps fitted with EBSRAY mechanical seals:**

9. (If fitted with non-metallic Bearing, Fit O-Ring to Extraction Washer and slide Extraction Washer along Shaft until seated against Bearing.) Slide Circlip along Shaft ensuring gap in Circlip lines up with access hole. Take care to avoid scratching Shaft.
10. Slide Circlip Retainer along Shaft until located against Circlip (a suitable tube may help, keep drive screw inline with access hole), tighten Drivescrew.
11. Insert Spring, Drivewasher, Rotating O-Ring, Rotating Face, Stationary Face, Stationary O-Ring and Mechanical Seal Plate. Note: Particular care must be taken to avoid contamination of lapped seal surfaces by any foreign matter. All parts should be lubricated before assembly and Drivescrews must be located during assembly. Mechanical Seal Plate must be fastened evenly.

.....**For pumps fitted with packed glands:**

9. Place Packing rings in position in accordance with normal packing procedures. For standard square Packing with one Lantern Ring, use eight (8) rings of 12.7mm square Packing. For other types of packing refer to suppliers instructions.
10. Position Gland Plate and tighten by hand only.
11. Final adjustment is carried out during operation of pump. Packed glands, when adjusted correctly are designed to have a very small amount of seepage. If packing is too tight it will generate excessive heat, if too loose it will leak excessively.
12. Lubricate Lipseal on Inner Lockring and slide Lockring along Shaft, screw Lockring in until it protrudes

approximately 4mm from thread on pump side.

13. Fit Inner Spacer to shaft and fit Bearing Spacer Sleeve to Bracket. Lubricate Bracket Ball Bearing. Fit Bearing to Shaft and drive Bearing into position against Inner Spacer using a suitable drift. Bearing should only be tapped on by using a drift on its inner ring. Tapping on the outer ring could damage the bearing.
14. Lubricate Outer Lockring Lipseal and screw Outer Lockring into Bracket.
15. Slide Ball Bearing locknut along Shaft through Lipseal and tighten firmly using a suitable tool. Tighten Locknut Locking Screws.
16. Replace lubrication/cooling circulation harness assemblies if fitted.

#### 4.7 ROTOR AXIAL CLEARANCE ADJUSTMENT

The Inner and Outer Lockrings when finally positioned determine the Bracket Ball Bearing location within the Bracket. As the Ball Bearing is positively locked to the Shaft shoulder by the Bearing Locknut, the positioning of the Ball Bearing will control the Rotor axial clearance.

To adjust axial clearance:

- a) A crank handle or other suitable arrangement should be affixed on the coupling end of the Rotor/Shaft assembly to facilitate rotating of the assembly by hand.
- b) Screw Outer Lockring in a clockwise direction whilst simultaneously rotating assembly. This enables sensing the rotor-cover point of contact i.e. a slight drag is felt by hand.
- c) Mark Outer Lockring position relative to Bracket i.e. establish a datum point for setting axial clearance.
- d) Back off Outer Lockring 180 degrees to eliminate any backlash.
- e) Reposition Outer Lockring to a point measured radially from the previously marked datum equal to the amount of desired axial clearance.

**Note:** For models HD300 & HD400 – Std Bracket, 4.71 mm radial movement on the O.D. of the Outer Lockring equals 0.025 mm axial movement of the Rotor/Shaft assembly. Refer Table of Clearances for actual clearances.

Example: Standard 'A' clearance 0.13 - 0.18 mm

$$(0.10 \div 0.025) \times 4.71 = 18.8$$

$$(0.15 \div 0.025) \times 4.71 = 28.3$$

is equivalent to 18.8 – 28.3 mm radial movement on the outside diameter of the Outer Lockring.

- f) Screw in Inner Lockring to lock hard against ball bearing. At this point, check for freedom of rotation of assembly. Axial clearance should now be established.
- g) Tighten Inner and Outer Lockring Lockscrews.

## SECTION 5 - INTEGRAL BYPASS VALVES

### 5.1 GENERAL

This Bypass Valve is intended for integral installation in EBSRAY's Internal Gear Pumps. The valve is mounted in such a manner as to return liquid from the discharge side of the pump to the inlet side of the pump when differential pressure reaches or exceeds a preset level.

The Bypass Valve is mounted with the Adjusting Screw pointing toward the inlet chamber of the pump.

### 5.2 OPERATION

The BYPASS VALVE is spring loaded and adjustable within a pressure range determined by the actual spring used. EBSRAY can supply a variety of springs to suit varying differential pressures. They are designed for liquid service and to provide pump and drive protection from excessive differential pressures above specified duty point parameters. Upon commissioning, the Bypass Valve should be adjusted in accordance with the predetermined pump differential pressure required.

### 5.3 MAINTENANCE

*PRIOR TO ANY DISASSEMBLY OR SERVICE, VERIFY THAT ALL REQUIREMENTS OF STATUTORY REGULATIONS OR CODES ARE MET AND THAT SPECIFIC SITE REQUIREMENTS ETC. ARE SATISFIED.*

Apart from Bypass Valve Body replacement, other maintenance tasks and inspections can be carried out with the Bypass Valve fixed to the pump Cover, so long as complete isolation, depressurising and purging have been completed.

### 5.4 DISASSEMBLY

1. Remove Adjusting Screw Cap. (if fitted)
2. Unlock Adjusting Screw Locknut.
3. Release spring pressure by rotating Adjusting Screw anti-clockwise.
4. Unscrew/unbolt the Bypass Valve Cap from the Bypass Valve Body.
5. Remove the Cap assembly complete with Adjusting Screw, Locknut, Gasket, Spring Cap and, Valve.
6. Remove Adjusting Screw and Locknut from Cap.
7. Remove Valve from Body.

### 5.5 INSPECTION

1. Inspect Bypass Valve Body, particularly valve seat, for damage or wear. If required remove Bypass Valve Body and re-machine or replace.
2. Check Valve for damage or deposits. Clean thoroughly or replace Valve as required. If worn, or if seat or Valve is damaged, lap cleaned/replaced Valve into valve seat.
3. Inspect Bypass Valve Spring. Replace if broken or damaged.

4. It is advised that all gaskets be replaced whenever disassembled.
5. Check Cap, Washer, Adjusting Screw and Locknut for damage. Replace as required.

### 5.6 REASSEMBLY

(Refer Drawing – Section 7)

1. Screw Locknut onto Adjusting Screw and then screw Adjusting Screw into Cap.
2. Fit Valve into Body, ensuring freedom of movement.
3. Fit Spring Cap and Spring into Cap.
4. Fit Gasket to Cap, position Cap on Body ensuring that the Spring locates correctly on the Valve.

NOTE This may be achieved easily by screwing the Adjusting Screw all the way in for positioning and then backing off the Adjusting Screw to Screw the Cap into the Body.

### 5.7 ADJUSTMENT

NOTE: Final adjustment is carried out after the valve is mounted on the pump.

1. For increased bypass pressure, rotate Adjusting Screw in clockwise direction ( i.e.screw in ). DO NOT exceed pump or system design pressure.
2. For decreased bypass pressure, rotate Adjusting Screw anti-clockwise (i.e. screw out).
3. Lock Adjusting Screw Lock Nut against Cap immediately after any adjustment is made.

NOTE: Bypass valves characteristically exhibit three distinct differential pressures during their operation :

- a) The set or 'cracking' pressure which occurs when product initially begins to be bypassed against the preset spring load.
- b) The maximum differential pressure developed when bypassed product passes through the Bypass Valve. This does not necessarily occur at full flow and is dependent on Bypass Valve Design.
- c) Full flow differential pressure which occurs when all the product being pumped passes through the Bypass Valve.

It is important to ensure the above characteristics are understood fully in order to correctly apply and adjust the Bypass Valve in a given system.



## SECTION 6 - TROUBLE SHOOTING

### 6.1 PUMP FAILS TO PRIME OR DELIVER LIQUID

- 1 No liquid in supply tank.
- 2 Not all valves open.
- 3 Incorrect direction of rotation.
- 4 Speed too low:
  - (a) If motor driven, check speed, line voltage and phases.
  - (b) If engine driven, check governor setting and engine speed.
- 5 System discharge head (pressure) too high - check system head, friction losses and bypass valve setting.
- 6 Excessive inlet (suction) restrictions - check NPSHA (undersized inlet piping may cause high friction losses or vapour pressure of liquid may be too high). Check with vacuum or compound gauge.
- 7 Air leaks and/or air pockets in inlet line - check piping.
- 8 Bypass valve setting too low or valve jammed open due to obstruction under seat of valve.
- 9 Inlet filter/strainer blocked or leaking air.
- 10 Pump cannot clear vapour due to excessive discharge pressure e.g. static head.

### 6.2 LOW OUTPUT FLOW

- 1 Discharge head (pressure) too high.
- 2 Entrained air or gases in liquid pumped.
- 3 Inlet filter/strainer blocked or leaking air.
- 4 Excessive inlet (suction) restrictions - check NPSHA (undersized inlet piping may cause high friction losses or vapour pressure of liquid may be too high). Check with vacuum or compound gauge.
- 5 Bypass valve pressure setting too low - Increase pressure. DO NOT exceed pump or system design pressure, or overload motor etc. (Refer adjustment instructions)
- 6 Insufficient NPSH available.
- 7 Excessive internal clearances in pump.

### 6.3 EXCESSIVE POWER CONSUMPTION

- 1 Differential pressure too high.
- 2 Bypass valve pressure setting too high. Decrease pressure. (Refer adjustment instructions)
- 3 Viscosity too high.
- 4 Rotating parts bind - check for proper clearances, galling or foreign matter in pump.
- 5 Bearings worn - inspect and replace as required.
- 6 Obstructions in pipe lines, clogged strainers, partially open valves.
- 7 Pump speed too high.
- 8 Voltage too low.

### 6.4 PUMP IS NOISY

- 1 Cavitation is taking place - increase NPSHA by:
  - (a) Removing inlet line restrictions created by:
    - (i) Undersize pipes / excessive line lengths.
    - (ii) Incorrect selection of valves, fittings etc.
    - (iii) Strainer restricting flow of liquid to pump.
  - (b) Increasing static head in supply vessel.
  - (c) Reducing product viscosity.
- 2 Rotating parts bind - check for proper clearances, foreign matter in pump, galling etc.
- 3 Pump and driver misaligned - check coupling and realign as required.
- 4 Mechanical damage to pump, check for galling or foreign objects in pump, if necessary dismantle pump and inspect.

## SECTION 7 - PARTS DESIGNATION

### EBSRAY Internal gear pump model HD 300 & HD400 – Std Bracket

CAT#	DESCRIPTION	QUANTITY
1	Body.....	1
3	Cover .....	1
3A	Cover Plate.....	1
5	Cover Gasket.....	1
5A	Cover Plate Gasket .....	1
17	Gland Plate.....	1
21	Gland Packing .....	To Suit
22	Mechanical Seal Rotating Face.....	1
23	Mechanical Seal Stationary Face.....	1
24	Mechanical Seal Drive Washer .....	1
25	Mechanical Seal Spring.....	1
27	Mechanical Seal Plate.....	1
29	Mechanical Seal Stationary O-Ring .....	1
30	Mechanical Seal Rotating O-Ring .....	1
31	Mechanical Seal Circlip .....	1
32	Mechanical Seal Circlip Retainer .....	1
36	Outer Rotor on Shaft assembly.....	1
48	Bypass Valve.....	1
49	Bypass Valve Body .....	1
50	Bypass Valve Body Cap.....	1
50A	Bypass Valve Cap Gasket.....	1
51	Bypass Valve Spring Cap.....	1
53	Bypass Valve Spring .....	1
54	Bypass Valve Lock Nut .....	1
54A	Bypass Valve Lock Nut Seal .....	1
55	Bypass Valve Adjusting Screw.....	1
56	Bypass Valve Adjusting Screw Cap .....	1
57	Bypass Valve Gasket .....	2
60	Inner Rotor.....	1
61	Inner Rotor Bearing .....	1
62	Inner Rotor Pin .....	1
63	Inner Rotor Pin Nut.....	1
64	Inner Rotor Pin Washer .....	1
64A	Inner Rotor Pin Spacer.....	1
68	Bracket .....	1
69	Rotor Bearing .....	1
69A	Extraction Washer (use with carbon Rotor Bearing).....	1
69B	Extraction Washer O-Ring (use with carbon Rotor Bearing) .....	1
70	Bracket Gasket.....	1
74	Bracket Ball Bearing.....	1
77	Bracket Ball Bearing Inner Lockring.....	1
79	Bracket Ball Bearing Inner Spacer .....	1
80	Bracket Ball Bearing Inner Seal .....	1
81	Bracket Ball Bearing Outer Lockring.....	1
83	Bearing Sleeve .....	1
84	Bracket Ball Bearing Outer Seal.....	1
85	Bracket Ball Bearing Locknut .....	1
100	Lantern Ring.....	1
135	Inner Rotor Pin Sealing Washer.....	1

NOTE: ..... This list covers various pump configurations, before ordering parts, please check the requirements for your particular pump. Ensure that Pump SERIAL No is quoted when ordering parts.

**Model HD300 – Std Bracket**

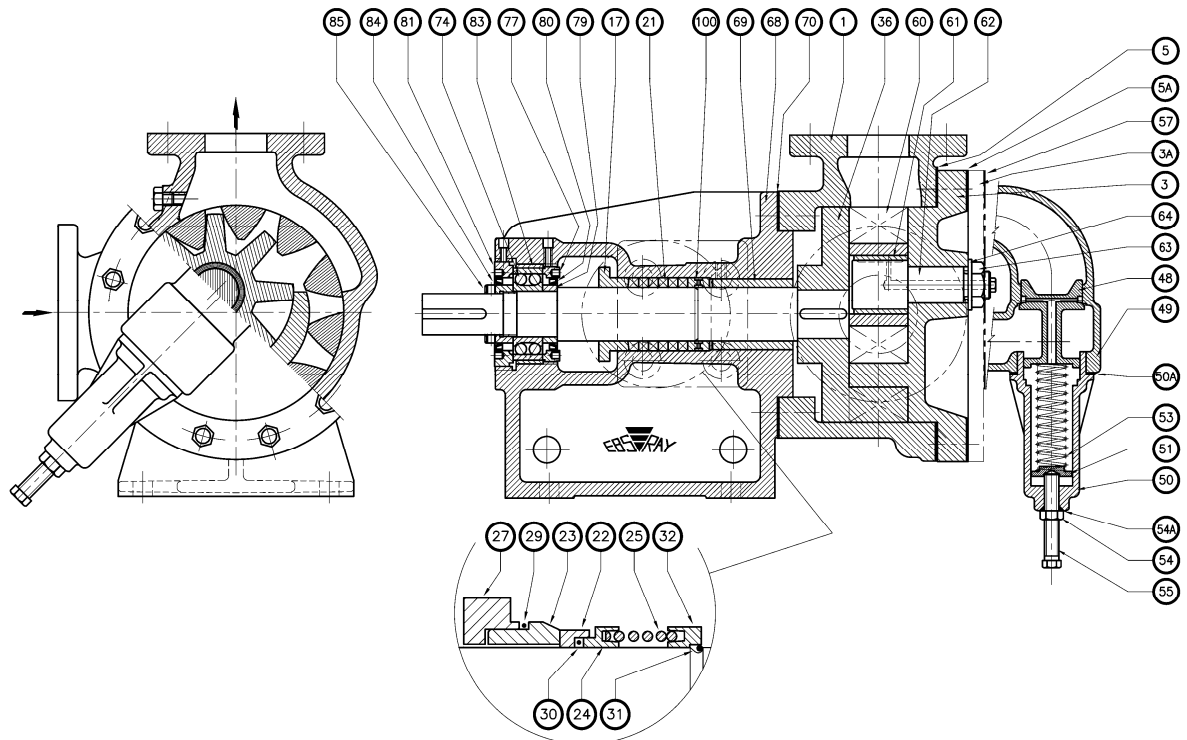

**Model HD400 – Std Bracket**

