



part of PSG | a **DOVER** company



# INSTALLATION, OPERATION & MAINTENANCE INSTRUCTIONS

## MODEL: R75 REGENERATIVE TURBINE PUMP

### 1.1 TABLE OF CONTENTS

1.1	TABLE OF CONTENTS	1
1.2	SAFETY DATA	1
1.3	ESSENTIAL HEALTH & SAFETY REQUIREMENTS	1
<b>SECTION 2 – PUMP DATA</b>		<b>2</b>
2.1	PUMP IDENTIFICATION	2
2.2	TECHNICAL DATA	2
2.3	INITIAL PUMP START UP INFORMATION	2
<b>SECTION 3 – INSTALLATION</b>		<b>3</b>
3.1	INTRODUCTION	3
3.2	WARRANTY	3
3.3	TRANSPORTATION, HANDLING & INSPECTION	3
3.4	PUMP LOCATION & PIPING CONNECTIONS	3
3.5	ALTERNATE INLET	4
3.6	PRE-INSTALLATION CLEANING	4
3.7	PUMP ROTATION	4
3.8	HYDRAULIC DRIVE	4
3.9	PUMP INTERNAL RELIEF VALVE	4
3.10	COUPLING ALIGNMENT	4
<b>SECTION 4 – OPERATION</b>		<b>5</b>
4.1	PRE-STARTUP CHECKLIST	5
4.2	COMMISSIONING/STARTUP PROCEDURE	5
4.3	PERIODIC INSPECTION	5
<b>SECTION 5 – MAINTENANCE</b>		<b>6</b>
5.1	ROUTINE MAINTENANCE & INSPECTION	6
5.2	MAINTENANCE – REPAIR & OVERHAUL	6
5.3	SPARE PARTS	6
5.4	INSPECTION UPON DISSASSEMBLY	6
5.5	IMPELLER & MECHANICAL SEAL REPLACEMENT	7
5.6	BEARINGS OR SHAFT REPLACEMENT	8
5.7	VALVE & VALVE SPRING REPLACEMENT	8
5.8	RE-HANDLING THE PUMP	8
<b>SECTION 6 – PARTS DESIGNATION</b>		<b>9</b>
<b>SECTION 7 – TROUBLESHOOTING</b>		<b>11</b>

### 1.2 SAFETY DATA



**This is a SAFETY ALERT SYMBOL.**

When you see this symbol on the product, or in the manual, look for one of the following signal words and be alert to the potential for personal injury, death or major property damage.



**Warns of hazards that WILL cause serious personal injury, death or major property damage.**



**Warns of hazards that CAN cause serious personal injury, death or major property damage.**



**Warns of hazards that CAN cause personal injury or property damage.**

**NOTE:**

**Indicates special instructions which are very important and must be followed.**

### 1.3 ESSENTIAL HEALTH & SAFETY REQUIREMENTS

This publication is intended to assist those involved with the installation, operation and maintenance of the R75 Regenerative Turbine Pump and **MUST** be kept with the pump.

Thoroughly review this manual, all instructions and hazard warnings, **BEFORE** performing any installation, operation or maintenance.

Maintain **ALL** system and Ebsray liquefied gas pump operation and hazard warning decals.

This publication is **TYPICAL ONLY**.

Ebsray reserves the right to retract or alter this or any other relevant documents at any time without notification. Ebsray also reserves the right to determine the validity of any warranty claims based on the proper application of Ebsray supplied equipment by way of adherence to the specifications within this publication and any other relevant Ebsray documents.

This Publication does **NOT** depict:

1. Ancillary required equipment related to the installation, operation & maintenance of the Pump e.g. miscellaneous flanges, fittings etc.
2. Required equipment unrelated to the pumpset e.g. tank fill lines, vapour return lines, emergency shutdown systems etc.

- 3. The materials and method of fabrication of any required sub-systems.

It is the responsibility of the designer, fabricator and the installer of each required sub-system to ensure that:

- a) The Ebsray specifications within this publication and any other relevant Ebsray documents are **STRICTLY** adhered to.
- b) Any variation (including the use of equipment deemed "Equivalent") or addition to Ebsray specifications, as related to the pumpset and pumping system in general, meet Ebsray's minimum requirements.

- c) All design, fabrication and installation of the tank and sub-systems is **STRICTLY** in accordance with all relevant National, State and Local Directives, Standards, Codes and Regulations.
- d) All equipment is suitable for the hazardous area as defined by EN6079.10.1
- e) All Essential Health and Safety Requirements (EHSR's) as outlined in EN60079.14, EN15198, EN ISO 80079-36 and EN ISO 80079-37 are adhered to.

This product is CE marked (meaning the equipment has been assessed and supplied in conformity to those Directives), strict adherence with all instructions and recommendations forms an essential part in maintaining the product/equipment's conformity. Failure to comply with the instructions and recommendations contained in this Publication may void CE conformity.



**Failure to set the vehicle emergency brake and chock wheels before performing service can cause severe personal injury or property damage**

Hazardous machinery can cause serious personal injury.

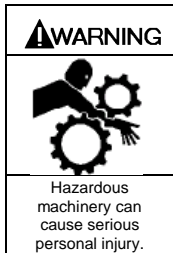

**Failure to disconnect and lockout electrical power or engine drive before attempting maintenance can cause severe personal injury or death**

Hazardous machinery can cause serious personal injury.

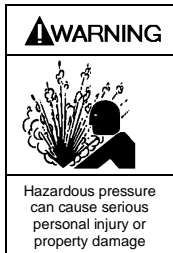

**Disconnecting fluid or pressure containment components during pump operation can cause serious personal injury or property damage.**

Hazardous pressure can cause serious personal injury or property damage



**Failure to relieve system pressure prior to performing pump service can cause serious personal injury or property damage. Systems with meters will still be pressurized even after the hose is emptied**

Hazardous pressure can cause serious personal injury or property damage

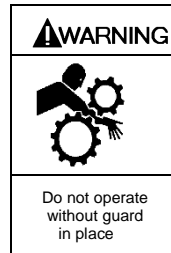

**Operation without guards in place can cause serious personal injury, major property damage, or death.**

Do not operate without guard in place

## SECTION 2 - PUMP DATA

### 2.1 PUMP IDENTIFICATION

A pump identification tag, containing the pump serial number, I.D. number, and model designation, is attached to each pump. It is recommended that the data from this tag be recorded in SECTION 2.3. If replacement parts are needed, or if information pertaining to the pump is required, this data must be furnished to an Ebsray representative.

The R75 pump is listed by Underwriters' Laboratories for liquefied petroleum gas service.

### 2.2 TECHNICAL DATA

Maximum Operating Temperature	135°C (275°F)
Maximum Pump Speed	3450 RPM
Maximum Differential Pressure	1400 kPa (14 Bar)
Maximum Working Pressure	2920 kPa (29.2 Bar)

Technical Data is for standard materials of construction. Consult Ebsray Material Specs for optional materials of construction.

### 2.3 INITIAL PUMP START UP INFORMATION

Model No.	
Serial No.	
Equipment No.	
Date of Installation	
Inlet Gauge Reading	
Discharge Gauge Reading	
Flow Rate	

## SECTION 3 - INSTALLATION

<b>⚠ WARNING</b>
<b>FRAGILE</b>
Foreign matter entering the pumps inlet will cause serious damage

Debris left in pipework will cause significant damage to the pump and will void the warranty.

<b>⚠ WARNING</b>
<b>FRAGILE</b>
Follow all lifting codes and do not drop the pump

Due care must be used when handling the pump. Failure to do so may result in serious personal injury or property damage.

<b>⚠ DANGER</b>
<b>FRAGILE</b>
Flush tank and supply piping prior to installing pump

Foreign matter entering the pump **WILL** cause serious damage to the pump

### 3.1 INTRODUCTION

**NOTE:**

**Ebsray pumps must only be installed in systems designed by qualified competent engineering personnel. System design must conform to all applicable regulations and codes and provide warning of all system hazards.**

**NOTE:**

**This installation must be performed by qualified, competent personnel and they must, completely read/review this entire document prior to starting any work. If any part of this publication is unclear, obtain clarification before proceeding with any work.**

**NOTE:**

**These instructions are additional to, and do not supersede or override any applicable statutory, legal or regulatory requirements.**

**NOTE:**

**New pumps contain residual test fluid and rust inhibitor. If necessary, flush pump prior to use.**

The design, materials and workmanship incorporated in the manufacture of Ebsray pumps make them capable of reliable operation over a long working life. Correct installation is essential to ensure a long service life.

When the equipment supplied utilises components other than those manufactured by Ebsray (e.g. electrical equipment, switches, fittings or valves), refer to the original manufacturer's data before installation or servicing is commenced. Failure to observe these details may void the Warranty.

### 3.2 WARRANTY

All Ebsray manufactured pumps and equipment are warranted as standard for one (1) year against faulty workmanship and/or materials. Refer to Ebsray pumps for details.

Ancillary equipment supplied by Ebsray but manufactured by others are not covered under Ebsray's warranty.

### 3.3 TRANSPORTATION, HANDLING & INSPECTION

Standard domestic packing is suitable for shipment in covered transports. When received, inspect the pump/pumpset against dispatch documentation and for damage.

Any damage or shortage incurred during transit should be noted on the packing note and on both your own and the carrier's copy of the consignment note.

Should a shortage be evident on receipt, notify Ebsray immediately giving full details and packing note number. Additionally a claim should be made with the transport company.

When received on site the pump set must be stored in a dry covered area.

**NOTE:**

**Never allow water or any corrosive product to enter the pump. Hydrostatic testing of pipework with pump installed may void the Warranty.**

If the pump/pumpset is not installed and commissioned immediately or has been removed from service, then the pump internals should be filled or thoroughly flushed with a light rust inhibiting hydrocarbon fluid. In addition to this pump ports must be sealed to exclude ingress of condensation, moisture or foreign material.

### 3.4 PUMP LOCATION & PIPING CONNECTIONS

The R75 pump is designed to flange mount directly or remotely to a commercial internal control valve in combination with the tank of a bobtail truck or transport.

Pump life and performance will be significantly reduced when installed in an improperly designed system. Before starting the layout and installation of the piping system, review the following:

1. When locating the pump, safety **MUST** be the first consideration.
2. The discharge hose and fittings should be large enough to minimize the pressure drop in the system. The lower the friction loss, the higher the flow rate.
3. All piping and fittings **MUST** be properly supported to prevent any piping loads from being placed on the pump.

- Check alignment of pipes to pump to avoid strains which might later cause misalignment. See Figure 1. Unbolt flanges or break union joints. Pipes should not spring away or drop down. After pump has been in operation for a one to two weeks, completely recheck alignment.

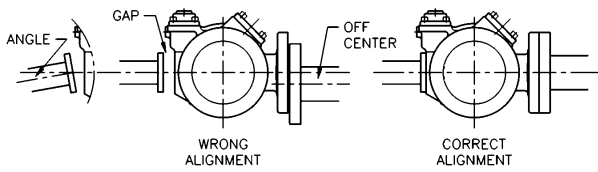

**NOTE:**  
Pumps with welded connections contain non-metallic O-ring seals that will be damaged if welding is done with these O-rings installed.

Prior to welding the piping, remove the O-rings from under the alternate inlet flange and discharge flange. After the welding is complete, reinstall the lubricated O-rings into the cleaned O-ring grooves.

Ebsray recommends that the pump and its inlet pipework are painted white.

### 3.5 ALTERNATE INLET

The alternate inlet port can be used as a fill connection for bottom loading of the tank by stationary pumps at the terminal or bulk plant. It can also be used as an alternate pump inlet, allowing the pump to unload another tank in an emergency.

To minimize vapor formation, the alternate inlet line must be as large in diameter as the inlet port (DN50) and as short as possible. The line must be connected through a suitable strainer using a minimum 40 mesh strainer screen.

### 3.6 PRE-INSTALLATION CLEANING

**NOTE:**  
New pumps contain residual test fluid and rust inhibitor. If necessary, flush pump prior to use.

The supply tank and intake piping MUST be cleaned and flushed prior to pump installation and operation.

### 3.7 PUMP ROTATION

**NOTE:**  
Confirm pump rotation by checking the pump rotation arrows respective to pump driver rotation.

The pump rotation is always clockwise looking from the shaft end. See SECTION 5.7 for instructions for re-handing the pump.

### 3.8 HYDRAULIC DRIVE

R75 truck mounted pumps are designed to be hydraulically driven and PTO driven. Hydraulic motors should be well supported with their shafts parallel to the pump shaft in all respects.

Ebsray provides an optional close-coupled hydraulic motor adapter. The adapter provides for straight alignment of a hydraulic motor drive through a coupling connected to a straight key pump shaft.

### 3.9 PUMP INTERNAL RELIEF VALVE

**NOTE:**  
The pump internal relief valve is designed to protect the pump from excessive pressure and must not be used as a system pressure control valve.

For ALL liquefied gas applications, install an external bypass valve which must have a free and clear passage back to the tank.

External Bypass Valves are integral to the performance and operation of liquefied gas pumps and control the maximum operating differential pressure of the system.

DO NOT pipe the bypass valve back into the pumps inlet line. The setting on the external bypass valve must not exceed 1400 kPa (14 Bar). The pumps non-adjustable internal relief valve is factory set to 1450 kPa (14.5 bar)

### 3.10 COUPLING ALIGNMENT

To maximise the life of the pump appropriate alignment of the coupled shafts is a fundamental requirement of any coupling installation. If pump was supplied by Ebsray as part of a pumpset unit, pump and driver have been accurately aligned at factory.

To ensure that alignment has been maintained during transit and installation, alignment MUST BE CHECKED upon final installation and prior to startup.

Ensure 'distance between shaft ends' (DBSE) is correct for the type of coupling utilised.

#### Angular misalignment

As shown in Figure 2 where shafts are at an angle to one another should be corrected before parallel misalignment.

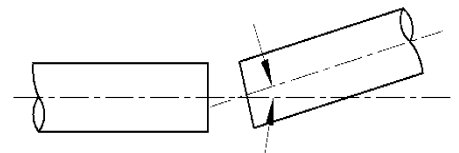

#### Parallel misalignment

As shown in Figure 3 where shafts are in line angularly and parallel to each other but are offset can now be corrected.

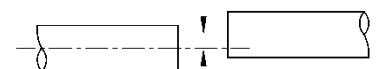
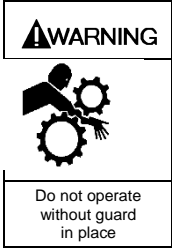

Figure 3

Horizontal adjustment by use of shims under the driver (or pump) will effectively correct error in the vertical plane.

## SECTION 4 - OPERATION



**Operation without guards in place can cause serious personal injury, major property damage, or death.**

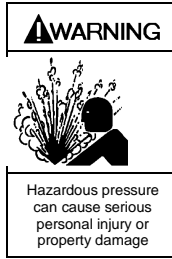

**Disconnecting fluid or pressure containment components during pump operation can cause serious personal injury or property damage.**



**Failure to relieve system pressure prior to performing pump service can cause serious personal injury or property damage. Systems with meters will still be pressurized even after the hose is emptied**

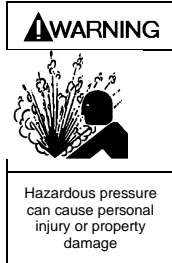

**Pumps operating against a closed valve can cause system failure, personal injury and property damage**

### 4.1 PRE-STARTUP CHECKLIST

- a) Check the alignment of the pipes to the pump. Pipes must be supported so that they do not spring away or drop down when the pump flanges or union joints are disconnected.
- b) Install pressure gauges in the 1/4" NPT ports located on the pump casing. These can be used to check the actual inlet and discharge conditions after pump start-up.
- c) Inspect complete piping system to ensure that no piping loads are being placed on the pump.
- d) Secure appropriate hose connections. Check entire piping system not leaking.
- e) Check shaft rotation and freedom of shaft rotation.
- f) Open inlet and discharge valves.

Inspect pump frequently during the first few hours of operation for such conditions as excessive heating of ball bearings, vibration or unusual noises.

**NOTE:**

**Consult SECTION 7 of this manual if difficulties during start up are experienced and troubleshooting is required.**

### 4.2 COMMISSIONING/STARTUP PROCEDURE

1. Open the shut-off valve in the bypass return line.
2. Open the tank outlet valve (same as pump inlet valve).
3. Start the pump. Confirm proper pump rotation by checking the pump rotation arrow on the cover.
4. Check the pump speed. Pump speed must never exceed the recommended maximum. Refer to SECTION 2.2 of this manual.
5. Check the pressure gauges to ensure the system is operating within expected parameters. Record the gauge readings in SECTION 2.3 of this manual for future reference.
6. Inspect piping, fittings, and associated system equipment for leaks, noise, vibration and overheating.
7. Close the discharge valve and check the differential pressure. It must not exceed the pressure setting of the external bypass valve.

### 4.3 PERIODIC INSPECTION

Periodic inspection of the Pump, Pump System and Ancillary Equipment is required to maintain safety, conformity, operational functionality and reliability.

If any abnormal condition is discovered, cease operation of pump immediately and take action to rectify the problem.

For safe operation, the following items should be included in the routine periodic inspection:

1. Inspect the system for leaks, vibration, abnormal noises, and signs of overheating or discoloration.
2. Inspect coupling assembly for signs of wear, overheating or discoloration
3. Check Pump differential pressure
4. Check Motor Current.
5. Inspect motor for vibration, abnormal noises, and signs of overheating or discoloration.

## SECTION 5 - MAINTENANCE



**Failure to set the vehicle emergency brake and chock wheels before performing service can cause severe personal injury or property damage.**

Hazardous machinery can cause serious personal injury.

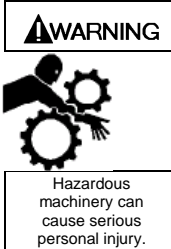

**Failure to disconnect and lockout electrical power or engine drive before attempting maintenance can cause severe personal injury or death**

Hazardous machinery can cause serious personal injury.

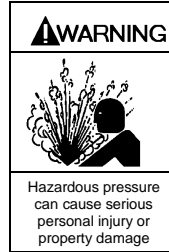

**Failure to relieve system pressure prior to performing pump service can cause serious personal injury or property damage. Systems with meters will still be pressurized even after the hose is emptied**

Hazardous pressure can cause serious personal injury or property damage

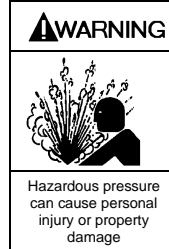

**Disconnecting fluid or pressure containment components during pump operation can cause serious personal injury or property damage.**

Hazardous pressure can cause personal injury or property damage

### 5.1 ROUTINE MAINTENANCE & INSPECTION

**NOTE:**

**Maintenance shall be performed by qualified technicians only, following the appropriate procedures and warnings as presented in this manual.**

Routine maintenance and inspections can be performed with the pump "in-situ", so long as complete isolation, depressurising and purging procedures have been completed. However for repair/overhaul, it is recommended that the pump be removed from the installation.

The R75 ball bearings are sealed for life. As such there are NO routine maintenance requirements.

Ebsray recommends a maximum interval of three months or 500 hours operation between routine inspections (More frequent inspections may be necessary dependent upon usage, site conditions, and operation). These inspections should include (but not limited to) checking for;

- Leakage from the pump, • Excess vibration/noise pipework, valves etc.
- Excessive heat from the R75 or hydraulic system.

### 5.2 MAINTENANCE – REPAIR & OVERHAUL

If the pump is being sent to Ebsray for maintenance or repair the pump must be fully flushed out. i.e. returned in the state it was provided.

Numbers in parentheses (i.e. Cover (2)) following individual parts indicate reference numbers specified in SECTION 6.

Steps before disassembly

1. Obtain the appropriate Work Permit if required.
2. Isolate power supply to motor – if fitted.
3. Isolate pump from liquids in inlet and discharge lines, depressurise and purge out any toxic, flammable, corrosive or air hardening liquids (if present).

Once the pump is removed from the pipework, flange O-rings and gaskets cannot be re-used.

Short video tutorials are available on the Ebsray pumps website covering main maintenance tasks.

Table 1: Torque required for bolted connections

Metric setscrew size	Reference number/s	Torque required in Nm (ft-lbs)
M12	6, 27	100 (75)
M10	100B, 103B	58 (43)
M6	99B	13 (10)
M5	57A	7 (5)

Tools required for maintenance:

- Metric Allen key set
- Metric socket drive Allen key set
- Torque wrench
- Small flat head screwdriver
- Short (100mm long) piece of 1-1/4 inch schedule 40 pipe
- Soft head mallet
- External circlip pliers

Before any re-assembly ensure all parts are deburred and cleaned. All O-rings MUST be replaced when any disassembly occurs.

### 5.3 SPARE PARTS

When ordering spare parts, to minimise pump downtime, ALWAYS quote the pump Serial Number located on the nameplate of the pump or SECTION 2.3 of this publication.

**NOTE:**

**Substitute or so-called 'equivalent' spare parts are not to be used. Safe operation and pump performance may be severely compromised if any substitute parts are used. The use of substitute parts may void the warranty.**

### 5.4 INSPECTION UPON DISASSEMBLY

1. Check Impeller (3) and seal zone of the Bearing Housing (20) for damage or wear. Replace Impeller if blades have been damaged or wear exceeds minimum recommended dimensions:
  - Minimum Impeller width is 21.70mm
  - Minimum outside diameter is 155.75mm.
2. Check Shaft for wear, damage or run-out. Replace as required.
3. Inspect both Bearings for wear. It is recommended during major overhauls that Bearings be replaced. Ball bearings are to be replaced after 50,000 operational hours.
4. Check Mechanical Seal components for wear or damage. It is recommended during major overhauls that Mechanical Seal components be replaced.

**5.5 IMPELLER & MECHANICAL SEAL REPLACEMENT**

The removal or replacement of the Impeller (3) or Mechanical Seal Assembly (56) requires the respective Kits K900300 and L752-27-096-05 supplied by Ebsray.

<b>Impeller Kit:</b>	<b>Mechanical Seal Kit:</b>
Impeller (3)	Seal Seat O-ring (48)
Impeller Key (8)	Cartridge O-ring (57B)
M8x12mm socket	Cartridge O-ring (57C)
Cover O-ring (4)	Oil Seal – Secondary (55)
2 0.004 inch (0.1mm) feeler gauges	Mechanical Seal Assembly (56)
2 M8x75mm setscrews	

The pump should rest on its inlet flange.

1. Remove the Cover's eight cap head setscrews (6). If required fit two of the setscrews to the tapped jacking holes.
2. Remove the Cover (2), remove the Cover O-ring (4), discard and replace with lightly lubricated new O-ring.

**NOTE:**

**The cover is a very neat fit into the pump body. Do not use excessive force to remove the cover. If the cover gets stuck, gently rock loose or gently tap loose with a soft mallet.**

3. Loosen the Impeller's locking screw (10) and remove the Impeller (2) and Impeller Key (8). If required, use the provided M8x75mm setscrews as jacking screws.
4. Remove the Circlip (58). At this point you can remove the dynamic element by using two of the four cartridge cap head setscrews (57A) and fit them to the back of the Seal Sleeve (42) (part of the dynamic element (56)) and use as extraction screws. If replacing the entire seal follow steps below.
5. Remove the cartridge cap head setscrews and screw two of them into the Mechanical Seal Cartridge's (57) tapped jacking holes. Jack the Cartridge and/or Mechanical Seal Assembly (56) off the shaft.
6. Remove the dynamic element (41, 42, 45, 46 assembled) and Seal Seat (40) from the Cartridge. Remove the O-rings (57B & C) from the Cartridge and discard.



Figure 4

7. Fit a small screwdriver or punch to the Cartridge's holes and gently tap the Lip Seal (55) out (See Figure 4).
8. Clean the Cartridge using non-residual contact cleaner or similar.
9. Loosely fit the new Lip Seal to the Cartridge (with the lip facing out, See Figure 5). Using the piece of 1-1/4 inch pipe as a drift, gently tap the Lip Seal into the Cartridge. Ensure that the Lip Seal is flat (flush) by checking the holes in the back of the Cartridge.



Figure 5

10. Fit the smallest new O-ring (48) to the Seal Seat and lightly lubricate.
11. Without removing the protective cover, press the Seal Seat into the Cartridge with fingers (ensuring complete and square engagement).
12. Remove the protective cover from the Seal Seat, clean with non-residue contact cleaner.

13. Fit the new O-rings (57B & 57C) to the Cartridge and lightly lubricate. The smaller cross section O-ring goes on the back.
14. Lightly lubricate the Cartridge O-rings, Lip Seal and bore of the Bearing Housing (20).
15. Aligning the four holes of the Cartridge with the tapped holes in Bearing Housing, fit the Cartridge to the Bearing Housing.
16. Fit the four Cartridge cap head setscrews with 'Loctite 243' or similar and tighten to 7N-m (5ft-lbs).
17. Remove the protective cover from the dynamic element and clean face with non-residual contact cleaner. Lightly lubricate the new internal Shaft O-ring (46) and lubricate seal face with clean light machine oil.

18. Aligning the dynamic element pin with the Impeller's keyway, fit the dynamic element onto the shaft and rest gently on the Seal Seat's face.
19. Loosely fit the Circlip (58) onto the shaft. Using the 1-1/4 inch pipe as a press tool, snap the circlip into place. Ensure the Circlip is correctly seated (See Figure 6).
20. Rotate the Shaft (21) such that the impeller keyway is at the 3 o'clock position. Fit the new Impeller Key (8) to the keyway.



Figure 6

21. To set the Impeller (3) clearance, tape the feeler gauges as shown in Figure 7 such that the ends come up against the shaft.
22. Fit the Impeller to the shaft and then fit the Impeller's locking screw (10) tightly to the Impeller with Loctite 243 or equal.

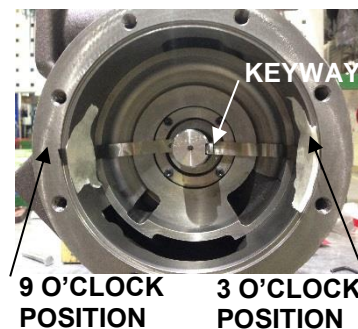

Figure 7

**NOTE:**

**The feeler gauges must be aligned horizontally at 9 o'clock & 3 o'clock. While applying even pressure to the Impeller, tighten the locking screw.**

23. Remove the feeler gauges. If they are tight or stuck gently tap the shaft on the opposite side while pulling the feeler gauges.
24. Gently fit the Cover (2) to the Body (1). Do not force the cover into the body. If it gets stuck, gently rock loose or gently tap it in with a soft mallet.
25. Do a final check to ensure the Cover O-ring (4) is correctly located (See Figure 8), then hand fit the eight cover cap head setscrews (6). Torque setscrews to 100Nm (75 ft-lb's)



Figure 8

## 5.6 BEARINGS OR SHAFT REPLACEMENT

A press and two pieces of flat bar are required to remove the Shaft (21) and Bearing's fixed assembly from the Bearing Housing and also to remove and replace the Bearings from the Shaft.

To replace the Drive End Bearing (DEB, 24) and the Inspection End Bearing (IEB, 23) complete steps one to five in SECTION 5.4, then complete the following steps:

1. Remove the Driver Key (34).
2. Remove the Bearing Cap's (99) eight cap head setscrews (99B). Remove the Bearing Cap, remove the Bearing Cap's O-ring (99A), discard and replace with lightly lubricated new O-ring.
3. Replace the Bearing Dust Seal (33)
4. Push or gently tap the Impeller end of the Shaft (21) and Bearing's fixed assembly from the Bearing Housing.
5. Remove the Bearing Circlip (25), starting with the DEB, support the Impeller side of the DEB's inner raceway and press the driven end of the Shaft until the DEB is pushed off the Shaft.
6. Then support the driven side of the IEB and press from the Impeller end of the Shaft. Press until the IEB is pushed off the Shaft.
7. To press the IEB onto the Shaft fully support the inner raceway of the IEB using two pieces of flat bar (See Figure 9). Locate the Impeller end of the Shaft (Impeller has a 10mm wide keyway) through the IEB. Press the driven end of the shaft until it fully rests on its shoulder.

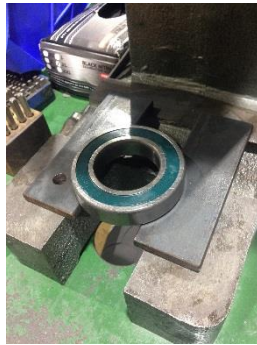

Figure 9

8. To press the DEB onto the Shaft, fully support the inner raceway of the DEB and press the Impeller end of the Shaft onto the DEB. Press the Impeller end of the Shaft until the circlip groove is fully exposed.
9. Fit the Bearing Circlip. Press the driven end of the Shaft and Bearing's fixed assembly into the Bearing Housing until the IEB is fully seated in the Bearing Housing.
10. Fit the Bearing Cap over the driven end of the Shaft. Check the Bearing Cap's O-ring is correctly located before, hand fitting the eight cap head setscrews. Torque the setscrews to 13 Nm (10 ft-lb's).
11. Replace the Driver Key. Continue on with step six of SECTION 5.4.

## 5.7 VALVE & VALVE SPRING REPLACEMENT

1. Remove the four Valve Cover cap head setscrews (103B).
2. Discard the Valve Cover O-ring (103A), and replace with a lightly lubricated new O-ring.
3. Remove the Bypass Spring. Then remove the Valve (105). If the Valve is stuck use pliers or similar to pull the Valve out.

### NOTE:

**Be careful not to scratch the Valve with the pliers as any foreign materials left inside the pump WILL seriously damage the pump.**

4. Fit the new Valve and or Bypass Spring then the Valve Cover.
5. Ensuring the valve cover O-ring is located properly, hand fit the four Valve Cover cap head setscrews. Torque setscrews to 58 Nm (43 ft-lbs).

## 5.8 RE-HANDING THE PUMP

Looking at the pump from the shaft end with the inlet flange up, the R75 can be configured with the alternate inlet on the left or the right.

1. Remove the eight cover cap head setscrews (6).
2. If required fit two of the setscrews to the tapped jacking holes.
3. Remove the Cover (2), remove the Cover O-ring (4), discard and replace with lightly lubricated new O-ring.

### NOTE:

**The cover is a very neat fit into the pump body. Do not use excessive force to remove the cover. If the cover gets stuck, gently rock loose or gently tap loose with a soft mallet.**

4. Lightly lubricate and refit to Cover, ensure that the O-ring is properly fitted.
5. Remove the eight bearing housing cap head setscrews (27). Repeat step two if required.
6. Remove the Bearing Housing (20), remove the Bearing Housing O-ring (26), discard and replace with lightly lubricated new O-ring.
7. Lightly lubricate and refit to the Bearing Housing, ensure that the O-ring is properly fitted.
8. Refit the Bearing Housing to the opposite side of the pump. The Bearing Housing inlet port aligns to the Body (1) inlet port.

### NOTE:

**This is guaranteed as one of the bolt holes is 1.5 degrees out of pitch. In other words if all eight bolts do not start in the Body's tapped holes the angular orientation is not correct.**

9. Do not force the Bearing Housing into the Body. If it gets stuck, gently rock loose or gently tap in with a soft mallet.
10. Do a final check to ensure the Bearing Housing O-ring is correctly located.
11. Fit all eight bearing housing cap head setscrews and torque to 100 Nm (75 ft-lbs).
12. Fit the Cover to Body, note that the raised cast text "IN" aligns with the Body's inlet flange. Again beware the close fit and don't force the cover in. Again check that the Cover O-ring is correctly located.
13. Fit all eight cover cap head setscrews and torque to 100 Nm (75 ft-lbs).



## SECTION 6 – PARTS DESIGNATION

Cat#	Description	Qty	Cat#	Description	Qty
1	Body	1	55	Lip Seal - Secondary seal	1
2	Cover	1	56	Mechanical Seal Assembly	1
3	Impeller	1	57	Cartridge - Mechanical seal	1
4	O-ring - Cover	1	57A	Cap Head Setscrew	4
6	Cap Head Setscrew	8	57B	O-ring - Cartridge primary	1
7	Plug - Gauge Tapping	2	57C	O-ring - Cartridge secondary	1
8	Key - Impeller	1	58	Circlip - Mechanical seal	1
10	Socket setscrew	1	99	Bearing Cap	1
20	Bearing Housing	1	99A	O-ring - Bearing Cap	1
21	Shaft	1	99B	Cap Head Setscrews	8
23	Ball Bearing - Inspection end	1	100	Adaptor Flange - Straight	1
24	Ball Bearing - Drive end	1	100A	O-ring - Adaptor Flange	2
25	Circlip - Bearing	1	100B	Cap Head Setscrews	8
26	O-ring - Bearing Housing	1	101	Adaptor Flange - Elbow	1
27	Cap Head Setscrew	8	101A	Adaptor Flange - Elbow Plug	1
33	Dust Seal - Bearing	1	102	Blanking Flange	1
34	Key - Driver	1	103	Valve Cover	1
40	Seal Seat	1	103A	O-ring - Valve cover	1
41	Seal Face	1	103B	Cap Head Setscrews	4
42	Seal Sleeve	1	104	Bypass spring	1
45	Seal Spring	6	105	Valve	1
46	O-ring - Shaft	1	106	Spring Cap	1
47	O-ring – Seal Sleeve	1	106A	O-ring - Spring Cap	1
48	O-ring - Seal Seat	1	107	Adjusting setscrew	1
<b>Adaptor Flange Options</b>					
Alternate Inlet			Discharge		
100	Adaptor Flange (Straight) - 2" NPT		100	Adaptor Flange (Straight) - 2" NPT	
100	Adaptor Flange (Straight) - Slip-on weld		100	Adaptor Flange (Straight) - Slip-on weld	
101	Adaptor Flange (Elbow) - 2" NPT		101	Adaptor Flange (Elbow) - 2" NPT	
101	Adaptor Flange (Elbow) - Slip-on weld		101	Adaptor Flange (Elbow) - Slip-on weld	
102	Blanking Plate (Mild Steel)				
102	Blanking Plate (Ductile Iron)				

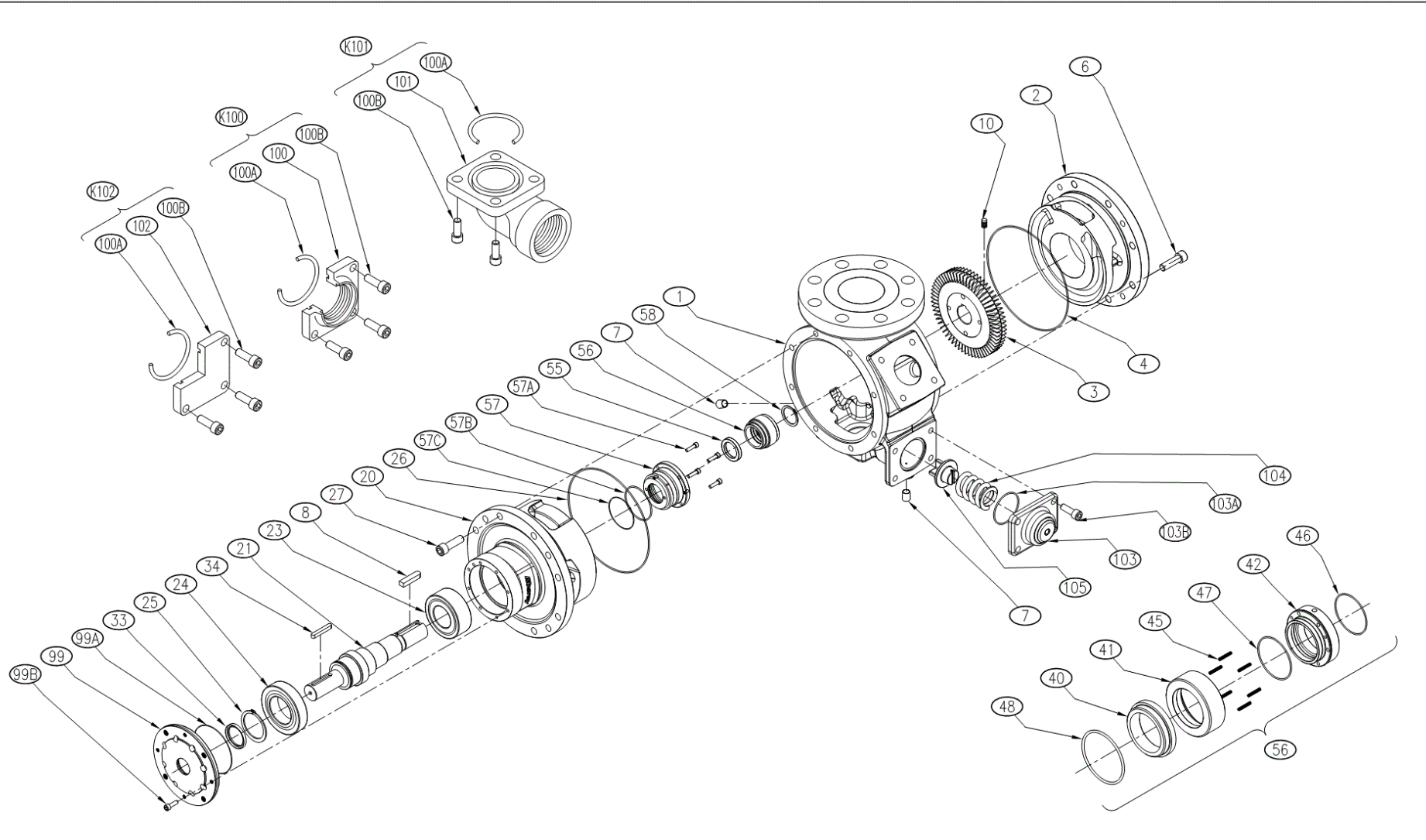

**Ebsray**  
part of PSG | a **BOVEL** company  
ABN 52 000 061 003

EBSRAY R75 PUMP  
EXPLODED VIEW  
DRG. No.: A900001L REV A  
DATE:17.03.17

## SECTION 7 – TROUBLESHOOTING

Symptom	Possible cause	Symptom	Possible cause
No Liquid Delivery	<ul style="list-style-type: none"> <li>• No power to drive shaft</li> <li>• Coupling damaged or disengaged</li> <li>• Foreign matter in the pump</li> <li>• Ball Bearings seized</li> <li>• Inlet/Discharge valves closed</li> <li>• No liquid in supply tank</li> <li>• Incorrect direction of rotation</li> <li>• Strainer blocked</li> <li>• High static discharge pressure</li> <li>• Inadequate N.P.S.Ha</li> <li>• Pump vapour lock</li> </ul>	Reduced Output	<ul style="list-style-type: none"> <li>• Incorrect driver speed</li> <li>• Faulty driver</li> <li>• Discharge piping restricted</li> <li>• Strainer blocked</li> <li>• Inlet piping too small or too long</li> <li>• Foreign object in suction line</li> <li>• External bypass pressure setting too low</li> <li>• End of service life or adverse pumping conditions</li> </ul>
Excessive Power Consumption	<ul style="list-style-type: none"> <li>• Foreign matter in discharge line</li> <li>• Collapsed or kinked discharge hose</li> <li>• Pressure, Viscosity, Temperature or Speed not as per design conditions</li> <li>• Foreign matter jamming parts</li> <li>• Pump out of alignment with driver</li> <li>• Parts worn</li> <li>• End of service life or adverse pumping conditions</li> </ul>	Excessive Noise	<ul style="list-style-type: none"> <li>• Foreign matter jamming parts</li> <li>• Parts worn</li> <li>• End of service life or adverse pumping conditions</li> <li>• Incorrect driver speed</li> <li>• Faulty or incorrect size driver</li> </ul>
Leakage from Pump	<ul style="list-style-type: none"> <li>• Seals incorrectly installed</li> <li>• Excessive dry running or pump</li> <li>• O-rings nicked, cut or twisted</li> <li>• O-rings not compatible with liquid</li> <li>• Worn or damaged shaft in seal zone</li> <li>• Misalignment causing excessive shaft distortion</li> <li>• Excess system pressure</li> <li>• O-ring failure</li> <li>• Fasteners not tightened to specified torque.</li> <li>• Thermal expansion of product when locked between valves either side of pump</li> <li>• Excessive static pressure</li> <li>• Seal faces cracked, scratched, pitted or dirty</li> </ul>		

***Ebsray***<sup>®</sup>

part of PSG | a **DOVER** company

Visit [www.ebsraypumps.com.au](http://www.ebsraypumps.com.au) for more information on any Ebsray products

156 South Creek Rd, Cromer 2099, Australia  
Telephone: (+612) 9905 0234 | Fax: (+612) 9938 3825  
Email: [sy.sales@psgdover.com](mailto:sy.sales@psgdover.com)