

EBSRAY PUMPS

INSTALLATION, OPERATION & MAINTENANCE INSTRUCTIONS

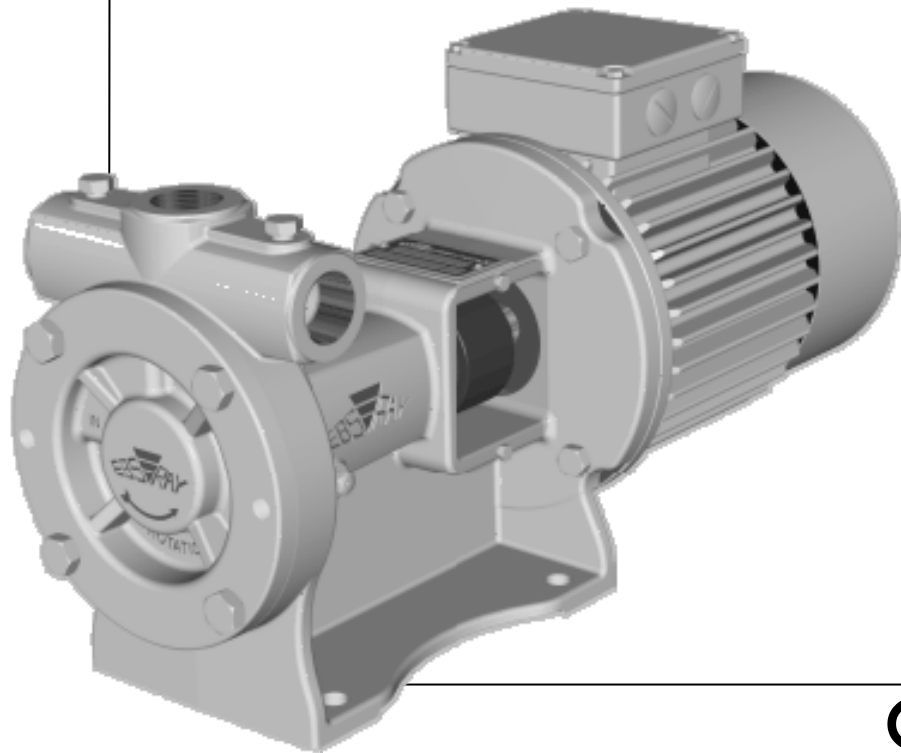

CE

RC SERIES MODELS RC20 & RC25

.... For LPG APPLICATIONS

CONTENTS

SECTION 1 – GENERAL	4
1.1 INTRODUCTION.....	4
1.2 TRANSPORTATION, PACKING & STORAGE	4
1.3 RECEIVING INSPECTION.....	4
1.4 HANDLING.....	4
1.5 WARRANTY.....	4
SECTION 2 – SYSTEM DESCRIPTION	5
2.1 EBSRAY RC20/RC25 LPG PUMPING SYSTEM.....	5
2.2 BYPASS VALVE – EBSRAY MODEL RV18 (VRS OR CBS OPTIONS).....	5
SECTION 3 – INSTALLATION	5
3.1 PUMP & SYSTEM LOCATION/INSTALLATION	5
3.1.1 Foundations.....	5
3.1.2 Coupling	5
3.1.3 Strainer	5
3.1.4 Pump Inlet	5
3.1.5 Pump Discharge	5
3.1.6 Bypass Valve.....	6
SECTION 4 – OPERATION	6
4.1 DESCRIPTION.....	6
4.2 LUBRICATION	6
4.3 PRE-STARTUP CHECKLIST	6
4.4 STARTUP PROCEDURE	6
4.5 PERIODIC INSPECTION	7
SECTION 5 – MAINTENANCE	7
5.1 PREPARATION FOR MAINTENANCE	7
5.2 TO REPLACE MECHANICAL SEAL ONLY	7
5.3 TO REPLACE COMPLETE QUILL ASSEMBLY ONLY.....	7
5.4 DISASSEMBLY	7
5.5 INSPECTION	8
5.6 SPARE PARTS	8
5.7 REASSEMBLY - PRELIMINARY.....	8
5.8 REASSEMBLY	8
SECTION 6 – PARTS DESIGNATION	10
APPENDIX A – TYPICAL INSTALLATION P&ID – (ABOVEGROUND)	16
APPENDIX B – SYSTEM PRE-STARTUP COMMISSIONING CHECKLIST	17
APPENDIX C – EBSRAY PUMP RUN LOG	18
APPENDIX D – DECLARATION OF CONFORMITY	19

EBS-RAY PUMPS Pty. Limited



628 Pittwater Road
Brookvale NSW 2100 Australia
Phone: (+612 9905 0234)
Fax: (+612 9938 3825)
www.ebsraypumps.com.au

or Contact Ebsray Representative:

IMPORTANT NOTES

1. This Publication is **TYPICAL ONLY** and only relates to the specifications of the minimum equipment required to ensure the optimum performance, maximum life and trouble-free operation of the Ebsray RC Series Pumps and the Pumping System in general.
2. Products with the mandatory European CE mark affixed indicate conformity to the essential health and safety requirements via their applicable EU Directives (e.g. ATEX 94/09/EC, Machinery 98/37/EC etc). As certain specific products/equipment outlined in this Publication are CE marked (meaning the equipment has been assessed and supplied in conformity to those Directives), **STRICT ADHERENCE** with **ALL** the instructions and recommendations forms an essential part in maintaining the product/equipment's conformity. **Failure to comply with the instructions and recommendations contained in this Publication may void CE conformity.**
3. This Publication does **NOT** depict:
 - a) Ancillary required equipment related to the fabrication, installation and operation of the Pumpset e.g. miscellaneous flanges, fittings etc.
 - b) Required equipment unrelated to the Pumpset e.g. tank fill lines, vapour return lines, emergency shutdown systems etc.
 - c) The materials and method of fabrication and/or installation of the tank and required sub-systems.
4. It is the responsibility of the designer, fabricator and the installer of each actual tank and required sub-systems to ensure that:
 - a) The Ebsray specifications within this Publication and any other relevant Ebsray documents are **STRICTLY** adhered to.
 - b) Any variation (including use of equipment deemed "Equivalent") or addition to the Ebsray Specifications, as related to the Pumpset and Pumping System in general, meet Ebsray's minimum requirements.
 - c) All design, fabrication and installation of the tank and sub-systems is **STRICTLY** in accordance with all relevant National, State and Local Codes, Regulations, Standards and Directives.
5. Ebsray reserves the right to:
 - a) Withdraw or alter any or all of the Ebsray specifications within this Publication and any other relevant Ebsray documents without notification.
 - b) Determine the validity of any Warranty claims for Ebsray equipment based on the proper application of Ebsray supplied equipment by the way of adherence to the Ebsray specifications within this Publication and any other relevant Ebsray documents.

Terms used in this publication requiring special attention:

1.  **DANGER**
Non-compliance with requirements under this heading could create circumstances which may lead to serious personal injury or death or substantial property damage.
2.  **WARNING**
Non-compliance with requirements under this heading could create circumstances which may lead to personal injury and/or which may cause damage to the Pumpset and/or ancillary equipment.
3.  **CAUTION**
Items under this heading draw attention to legal and/or statutory requirements which control the installation and use of this type of equipment. Non-compliance with these requirements may create a dangerous situation and/or result in damage to the Pumpset and ancillary equipment.
4. **NOTE:**
Items under this heading are to draw attention to assembly procedures, techniques and methods of operation etc. which are important to ensure correct installation and operation of equipment and which, if not followed, may result in damage, failure or poor performance of Pumpset and ancillary equipment.

ABBREVIATIONS:

AFL	Automatic Fill Limiting Valve
CBS	Constant Bleed System
EFV	Excess Flow Valve
FLA	Full Load Amps
VRS	Vapour Removal System

SECTION 1 – GENERAL

1.1 INTRODUCTION

This publication is intended to assist those involved with the installation, operation and maintenance of Ebsray RC Series Regenerative Turbine Pumps and the pumping system.

 **DANGER** Before starting any work, this publication should be completely read/reviewed by all persons involved with the work. If any part of this publication is unclear, obtain clarification before proceeding with any work.

 **DANGER** As LPG (Propane and Butane) is regarded as a flammable liquid, extreme caution must be taken to ensure total compliance with all necessary Statutory Standards, Directives, Codes and Regulations is fully understood and exercised in the installation, operation and maintenance of Ebsray RC Series pumps.

These instructions are intended to assist correct pump installation, operation and maintenance requirements. They are additional to, and do not supersede or override any applicable statutory, legal or regulatory requirements.

The design, materials and workmanship incorporated in the manufacture of Ebsray pumps make them capable of reliable operation over a long working life. Correct installation and operation is essential. Service life is enhanced by periodic inspection and careful maintenance.

 **CAUTION** Installation and servicing of this equipment should be performed by qualified competent personnel in accordance with relevant Standards, Directives, Codes, Regulations and site restrictions, in conjunction with these instructions.

When the equipment supplied utilises components other than those manufactured by Ebsray e.g. electrical equipment, switches, fittings, valves, etc reference should be made to the original manufacturer's data before installation or servicing is commenced. Failure to observe these details may void the Warranty.

 **WARNING** The pumpset must be operated within the original selected design parameters of pumped product (Use only LPG of internationally accepted (ISO) quality and specification), flow, pressure, temperature, voltage and current. Should any change be contemplated, please confer with Ebsray in order to verify the suitability of such a change

1.2 TRANSPORTATION, PACKING & STORAGE

Standard domestic packing is suitable for shipment in covered transports. Pump ports must be sealed to exclude ingress of condensation, moisture or foreign material. When received on site the Pump must be stored in a dry covered area..

NOTE: If Pump is not installed and commissioned immediately, special preservative techniques will be required. (Refer to Ebsray). e.g. If the Pump is installed, but not commissioned, low pressure nitrogen can be used to purge, seal and protect the Pump from the effects of condensation and atmospheric corrosion.

 **WARNING** NEVER allow water or any corrosive product to enter the pump (e.g. for hydrostatic testing of pipework). Severe internal damage may result and will void the Warranty

1.3 RECEIVING INSPECTION

SHORTAGES and/or DAMAGE: On receipt of equipment, check all items against the dispatch documents and inspect for damage. Any damage or shortage incurred during transit should be noted on the packing note and on both your own and the carrier's copy of the consignment note. A claim should be made immediately on the transport company.

Also advise Ebsray or their Appointed Representative. Should a shortage be evident on receipt, notify Ebsray immediately giving full details and packing note number.

1.4 HANDLING

Do not drop Pumpset! Care should be taken in moving/handling Pump/Pumpsets in order to minimise stress on the internal components.

The Pump/Pumpset should be lifted in such a manner as to ensure compliance with the relevant lifting codes. **Severe internal Pump damage may result if correct handling and due care is not taken.**

1.5 WARRANTY

1. All Ebsray manufactured pumps and equipment are warranted as standard for one (1) year against faulty workmanship and/or materials. Refer to Ebsray PUMPS 'Standard Conditions of Sale and Warranty' publication for details.
2. Ancillary equipment supplied by Ebsray but manufactured by others will be in accordance with those manufacturer's written warranty conditions

SECTION 2 – SYSTEM DESCRIPTION

2.1 EBSRAY RC20/RC25 LPG PUMPING SYSTEM

The RC Series Pumps are designed for installation aboveground when connected to aboveground storage tanks.

2.2 BYPASS VALVE – EBSRAY MODEL RV18 (VRS OR CBS OPTIONS)

The RC Series Pumps must be installed in conjunction with a bypass valve - connected back-to-tank. The EBSRAY Model RV18 fitted with VRS or CBS option is recommended. (Refer Appendix A - P & ID for details)

The Bypass Valve plays a pivotal role in the overall LPG system. It controls the following functions:

1. Maintains pump system differential pressure as required for optimum flow rates.
2. Controls Differential Pressure to maintain pump's and/or motor's correct operation within intended maximum operating parameters.
3. VRS option, when fitted, ensures rapid vapour passage for faster pump priming before acting in it's intended liquid handling mode.

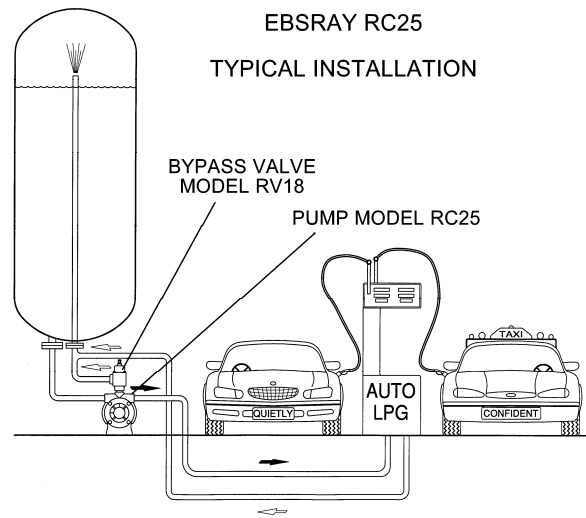

Fig 1

SECTION 3 – INSTALLATION

CAUTION Installation and removal of this equipment should be performed by suitably qualified competent personnel in accordance with relevant Directives, Standards, Codes, Regulations, and site restrictions - in conjunction with these instructions.

DANGER Never loosen or remove fittings, flanges, etc. while under pressure (vapour pressure of LPG may be very high), always isolate components or pipework and depressurise prior to work.

3.1 PUMP & SYSTEM LOCATION/INSTALLATION

Refer to P&ID Appendix A for system arrangement and relative positions of important components/equipment

3.1.1 Foundations

a) Pumpsets should be accurately and securely installed. When mounted direct on a concrete foundation, ensure that it has a solid footing and is levelled on the pump mounting surfaces.

b) Ensure floor area and headroom allotted is sufficient for inspection and maintenance. Allow for crane or hoist access if require

WARNING It is extremely important that no piping stresses be transferred to the pump.

3.1.2 Coupling

When using the coupling supplied by Ebsray – refer to Drg A316001C Rev C in Section 6. It is important that the sleeve moves freely in the axial direction

NOTE: Couplings must be of the non-sparking design and be in compliance with the relevant Directives, Standards, Codes & Regulations

3.1.3 Strainer

The pump inlet must always be protected by an efficient strainer of adequate size to accommodate the flow rate conditions without causing excessive inlet resistance or cavitation.

3.1.4 Pump Inlet

a) The pump is designed for installation with an adequately sized inlet pipe **with continuous fall** from the LPG liquid withdrawal outlet of the tank.

b) Ensure this aboveground (exposed) inlet piping is the shortest length possible – combined with the minimum diameter (without causing cavitation) – thus reducing the contained 'vapour volume' when priming.

c) Protection from direct sun will enhance pumping performance by minimising vaporisation in pump and inlet pipe. EBSRAY recommends that the pump and its inlet pipework are painted white.

NOTE: Debris e.g. welding materials, pipe scale, grinding swarf, shot blast material etc. left in the pipework or tank will cause serious pump damage and void the Warranty. Clean tank and pipework TOTALLY prior to pumpset installation.

3.1.5 Pump Discharge

Discharge pipe size is generally dependent upon run lengths at the specific site. Calculate as required to ensure optimum conditions and to minimise pressure drop.

3.1.6 Bypass Valve

Bypass Valve (Ebsray Model RV18-VRS or CBS) (Refer Appendix A - P & ID for details) is installed on the pump discharge side and returns back-to-tank. It may be mounted directly on the 'spare' discharge port or in the discharge pipe (before any isolation valve). This Bypass Valve is primarily for control of differential pressure. (NOTE: Variation in tank vapour pressure has a direct effect upon discharge pressure whilst constant differential pressure is maintained).

If VRS option is used (Refer Appendix A - P & ID for details), a critical function performed by this unique Bypass Valve is its rapid vapour handling capability

during the pump start-up/priming cycle. (Also refer to Ebsray RV18 Bypass Valve Brochure for details and functionality.)

Ensure correct orientation i.e. flow is 'IN' from pump discharge line and 'OUT' returns to tank.

NOTE: The Bypass Valve's return-to-tank pipeline MUST NOT have any restrictions which could adversely affect or limit the vapour clearing function during pump priming.

An Excess Flow Valve or other 'normally open' tank valve is recommended/ preferred.

Flow of LPG during bypassing should return to Storage Tank vapour space.

SECTION 4 – OPERATION

4.1 DESCRIPTION

1. Pump

The Ebsray RC Series pumps are designed for ultra quiet operation pumping LPG of Internationally accepted (ISO) quality and specification.

The Pump meets the requirements of Australian, European ATEX and other International Standards and Codes for use in potentially explosive atmospheres.

2. Motor

Certified explosion protected IEC frame 90 or 100 B5 Flange Mount 50Hz 2880 RPM or 60Hz 3500 RPM electric motors fit directly onto RC Series pumps.

The RC20 uses 1.5 or 2.2kW and the RC25 uses 2.2 or 3.0kW Motors which can be either supplied by EBSRAY or customer supplied. Motor must be wired with a correctly sized IEC class 10A thermal overload relay, and set to **no more than** the FLA of the motor.

Ensure motor conformity with all necessary Directives, Standards, Codes, Regulations and site requirements.

3. Coupling

Non-Sparking design (e.g. "polygear" type) – sized to suit duty. Supplied by Ebsray or customer supplied.

4.2 LUBRICATION

The Ball Bearings for the RC Series pumps are grease lubricated and 'sealed-for-life' design.

No 'in service' lubrication is required on EBSRAY's RC Series Pumps.

For motor, refer to specific motor manufacturer's recommendations.

4.3 PRE-STARTUP CHECKLIST

Refer to pre-start inspection checklist (Appendix B)

 **WARNING** *Do not run Pumpset dry. Do not start Pump against closed Discharge Valve. Severe internal damage to the Pumpset will result, voiding Warranty.*

4.4 STARTUP PROCEDURE

Fill in the 'Pump Run Log' provided in Appendix C

1. Ensure all conditions described in Pre-Startup Checklist have been met.
2. Check reading on discharge pressure gauge. Record product vapour pressure in the commissioning section of the Pump Run Log.

3. Back-off Bypass Valve Adjusting Screw (screw to maximum 'out' position).
4. Verify all site conditions and statutory requirements have been met.
5. Briefly activate power (i.e. 'jog' motor) to verify correct pump rotation. (Cast arrow on cover)
6. Start Pumpset.



WARNING *If any aspect of the pumpset or pumping system does not function properly, immediately turn the pump 'off' and rectify the problem before re-starting.*

7. After startup, pump should immediately begin to build **differential pressure**. If pump does not prime immediately, switch off to determine reason and rectify before re-starting.
8. After startup, initially ensure that liquid is flowing through Bypass Valve. This should be detectable by listening or feeling the Bypass Valve. Screw 'in' the Bypass Valve Adjusting Screw until the required system differential pressure is achieved. Record discharge pressure in the commissioning section of the Pump Run Log.
9. Check that motor current is below FLA rating. Record motor current readings in the commissioning section of the Pump Run Log.

NOTE: During this procedure, or at any time, motor current must not exceed FLA rating of motor.

10. Stop pump, restart and check for consistent results.
11. Record discharge pressure and current readings in the commissioning section of the Pump Run Log.
12. The Pumpset is now ready for normal operation.
13. After final Bypass Valve adjustment, tighten adjusting screw locknut and seal for security.
14. The startup procedure is now complete.
15. Inspect Pumpset/pumping system frequently during the first few hours of operation then periodically thereafter (see Section 4.5 for frequency). Record observations from these inspections in the Pump Run Log.

4.5 PERIODIC INSPECTION

Periodic Inspection of the Pump, Pump System and Ancillary Equipment is required to maintain safety, conformity, operational functionality and reliability. Ebsray recommends a maximum interval of three months or 500 hours operation between routine periodic maintenance inspections (More frequent inspections may be necessary dependent upon usage, site conditions, operation etc).

If any abnormal condition is discovered, cease operation of pump immediately and take action to rectify the problem. Record observations from these inspections in Pump Run Log.

For safe operation, the following items should be included in the routine periodic inspection:

- Inspect the Pump for LPG leaks, vibration, abnormal noises, signs of overheating, discolouration, etc.
- Inspect Coupling Assembly for signs of wear, overheating, discolouration, etc.
- Check Pump differential pressure
- Check Motor Current.
- Inspect motor for vibration, abnormal noises, signs of overheating, discolouration, etc.

SECTION 5 – MAINTENANCE

5.1 PREPARATION FOR MAINTENANCE



CAUTION

Prior to any system disassembly or service, verify that all requirements of statutory Codes, Regulations, Standards & Directives are met and that specific site requirements etc are satisfied. Obtain the appropriate Work Permit if required.

Most maintenance tasks and inspections can be performed with the pump 'in line' so long as complete electrical isolation, depressurising and purging procedures have been completed.

5.2 TO REPLACE MECHANICAL SEAL ONLY

Removal	Replacement
<p>Follow steps in Section '5.4 Disassembly' in the following order: 2,3,5,6,4,7.</p> <p>Inspect relevant components as described in Section '5.5 Inspection' and repair or replace as required.</p>	<p>Follow steps in Section '5.8 Reassembly' in the following order: 1,2,3.</p> <p>Fit Cartridge to Body before fitting and securing Mechanical Seal Assembly as shown in Fig 5.12 and Fig 5.13</p> <p>Then follow steps 10 and 11 in Section '5.8 Reassembly'</p>

5.3 TO REPLACE COMPLETE QUILL ASSEMBLY ONLY

Removal	Replacement
<p>Follow steps in Section '5.4 Disassembly' in the following order: 1,2,3,4,9.</p> <p>Inspect relevant components as described in Section '5.5 Inspection' and repair or replace as required.</p>	<p>Follow steps 3 & 7 to 14 in Section '5.8 Reassembly'</p>



CAUTION

Replace Ball Bearings at intervals not exceeding recommended operational hours. See Section 5.5.3

The following instructions are for complete pump disassembly (This may not be required - depending upon scope of maintenance)

5.4 DISASSEMBLY

(Refer Drg No A316001B – Section 6)

- Remove Motor, Coupling Guards, Pump Coupling half and Pump Shaft Key.
- Remove Cover, Impeller and Impeller Key.
- Unscrew four grub screws from Cartridge. Ref Fig 2
- Insert grub screws into the two extraction holes and screw in evenly to extract Cartridge or Quill Assembly.



Fig. 2



Fig 3 Complete Quill Assembly

NOTE: Complete Quill Assemblies are available from EBSRAY as a 'Spare Part' to enhance speed and efficiency of maintenance.

- Remove Circlip from end of Quill Assembly.

Refer Fig 4



Fig 4

- Remove Mechanical Seal Assembly (the Coupling Guard retaining screws may be screwed into the Impeller and/or Seal Assembly to aid removal).

- Remove Carbon Seal Seat and Lip Seal from Cartridge. Refer Fig 5



Fig 5

- Remove Circlip and press Bearings from Shaft.
- Remove Dust Seal (Bearing) from Body.

5.5 INSPECTION

- Check Impeller and Seal Zone of Body for damage or wear. Replace Impeller if blades have been damaged or wear exceeds minimum recommended dimensions. Refer Fig.6

MINIMUM IMPELLER DIMENSIONS mm		
Pump Model	RC20	RC25
Minimum worn width	8.86	9.86
Minimum worn diameter	109.86	109.86

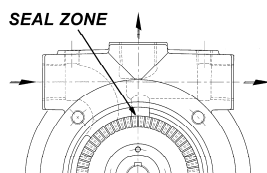

Fig 6

- Check Shaft for wear, damage or run-out. Replace as required.
- Inspect both Ball Bearings for wear. It is recommended on major overhauls that Ball Bearings be replaced.

Bearing Replacement recommended not exceeding 10,000 operational hours.

- Check Mechanical Seal components for wear or damage. It is recommended on major overhauls that Mechanical Seal components be replaced.
- It is recommended that as a standard procedure, all O-Rings be replaced at every overhaul or when any disassembly is conducted.

5.6 SPARE PARTS

- When ordering spare parts, to ensure a minimum of delay and correct replacement to original specification, **ALWAYS** quote the pump Serial Number located on the nameplate of the pump.
- Advise the name, Cat # and quantity required. Refer to Drg No A316001B (Section 6)
- Advise complete delivery instructions, transportation, etc.

NOTE: Substitute or so-called 'equivalent' item/spare parts are not recommended for use. Compliance, safe operation and pump performance may be severely compromised if incorrect or substitute spare parts – including Fasteners, O-Rings, Ball Bearings, etc – are used.

5.7 REASSEMBLY - PRELIMINARY

- Ensure all parts are clean before assembly. Remove any burrs.
- Ensure Impeller maintains an accurate free sliding fit on Shaft and key. **This is critical.**



CAUTION At all times when handling and installing mechanical seals, care must be taken to ensure lapped faces and seats are not damaged. Particular attention must be given to carbon seats to prevent marking or chipping.

- Lightly lubricate O-Rings, Lip Seals and Mechanical Seal Faces with a compatible good quality detergent-free light oil before assembly.

5.8 REASSEMBLY

(Refer Drg No A316001B & A316001L - Section 6)

Pump Fastener Torque settings		
M12	ISO Grade 8.8	85Nm
Motor Fastener Torque Settings		
M10	ISO Grade 4.6	20Nm
M10	ISO Grade 8	(nut)
M12	ISO Grade 4.6	30Nm
M12	ISO Grade 8	(nut)

Quill Assembly

- Fit Lip Seal to Cartridge. (note position of lip) Refer Fig 7



Fig 7

- Fit O-Ring to Seal Seat.
 - Fit Seal Seat to Cartridge. Refer Fig 8



Fig 8

- c) Press Seal Seat in with fingers. (Ensure complete and square engagement) Refer Fig 9

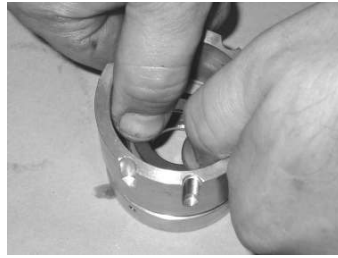

Fig 9

3. Fit Primary O-Ring to Cartridge then fit Secondary O-Ring. Refer Fig 10



Fig 10

4. a) Fit IE Bearing to Shaft. **(Note: this is an interference fit)** **(Note: Apply force to inner race of Bearing only.)**
b) Lock Bearing in position with Circlip. Refer Fig 11



Fig 11

5. Fit DE Bearing to Shaft. **(Note: this is an interference fit)** **(Note: Apply force to inner race of Bearing only.)** Refer Fig 12



Fig 12

6. a) Fit Bearing/Shaft Assembly into Cartridge.
b) Fit Seal rotating subassembly to Cartridge/Shaft Assembly. Refer Fig 13

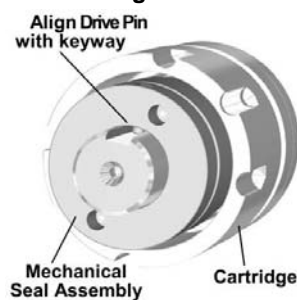

Fig 13

- c) Press down and lock in position with Circlip. (Fig 14)

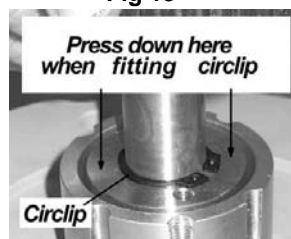

Fig 14

Final pump assembly

7. Fit Dust Seal to Body. (Note position of lip) Refer Fig 15



Fig 15

8. To assist assembly, lightly lubricate bore in cartridge zone with a compatible good quality detergent-free light oil and fit Quill Assembly to Body.



Fig 16

9. Lock in place with 4 grub screws. (apply Loctite 243 or equivalent to grub screws) Refer Fig 16

10. Fit Key and Impeller. Ensure Impeller maintains an accurate free sliding fit on Shaft and Key. **This is critical** Refer Fig 17



Fig 17

11. Fit O-Ring to Cover and fit Cover to Body. Tighten bolts to required torque as shown in Section 5.8. Refer Fig 18



Fig 18

12. Fit Key and Coupling half to Pump (and Motor if not already fitted). **Refer to Section 6: Drawing No: A316001C for dimensions.** (Apply Loctite 243 or equivalent to grub screws) Tighten grub screws. Refer Fig 19



Fig 19

13. Fit 'polygear' Coupling Element and securely mount Motor to Pump flange. **Note:** If IEC 100 frame motor is utilised, Motor Adaptor Kit must be fitted first.

14. Fit Coupling Guards.

Reassembly is now complete.

SECTION 6 – PARTS DESIGNATION

PARTS DESIGNATION - EBSRAY MODELS: RC20 & RC25 (Refer Drawing N^o: A316001B)

Cat #	Description	Qty	Cat #	Description	Qty
1	Body	1	37	Coupling Guard	2
2	Cover	1	37A	Setscrew -Coupling Guard	4
3	Impeller	1	38	Plug - Spare Port	1
4	O-Ring – Cover	1	39	Seal Drain Elbow	1
6	Bolt	4	55	Lip Seal - Secondary Seal	1
7	Plug –Gauge Tapping	2	56*	Mechanical Seal Assembly	1
8	Key – Impeller	1	Incl	#40 Seal Seat	1
21	Shaft	1	Incl	#41 Rotating Seal Face	1
23	Ball Bearing – Inspection End	1	Incl	#42 Seal Sleeve	1
24	Ball Bearing – Drive End	1	Incl	#45 Seal Spring	6
25	Circlip – Bearing	1	Incl	#46 O-Ring – Shaft	1
33	Dust Seal - Bearing	1	Incl	#47 O-Ring – Seal Sleeve	1
34	Key – Pump Shaft	1	Incl	#48 O-Ring – Seal Seat	1
36	Coupling Assembly	1	57	Cartridge - Mechanical Seal	1
incl	#36D Half Coupling – Motor	1	57A	Grubscrew	4
incl	#36E Coupling Element	1	57B	O-Ring – Cartridge Primary	1
incl	#36P Half Coupling – Pump	1	57C	O-Ring – Cartridge Secondary	1
			58	Circlip - Mechanical Seal	1
Motor Attachment – IEC D90 B5			Motor Attachment – IEC D100 B5		
29	Bolt – M10x40	4	35	Motor Adaptor Kit to suit D100	1
29A	Spring Washer – M10	4	incl	#29 Bolt – M12x50	4
29B	Nut – M10	4	incl	#29A Spring Washer – M12	4
			incl	#29B Nut – M12	4
			incl	#35A Motor Adaptor	1
			incl	#35B Stud – M10x40	4
			incl	#35C Nut – M10	4
			incl	#35D Spring Washer – M10	4

DIMENSIONS EBSRAY MODELS RC20 & RC25

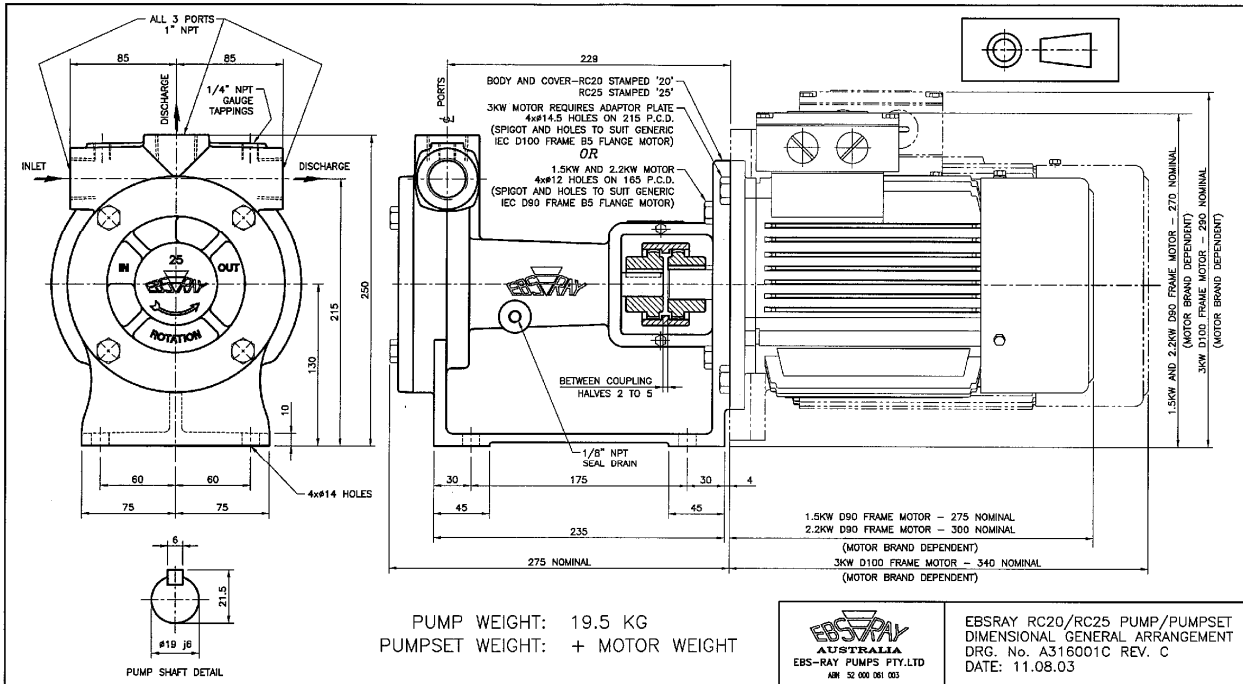

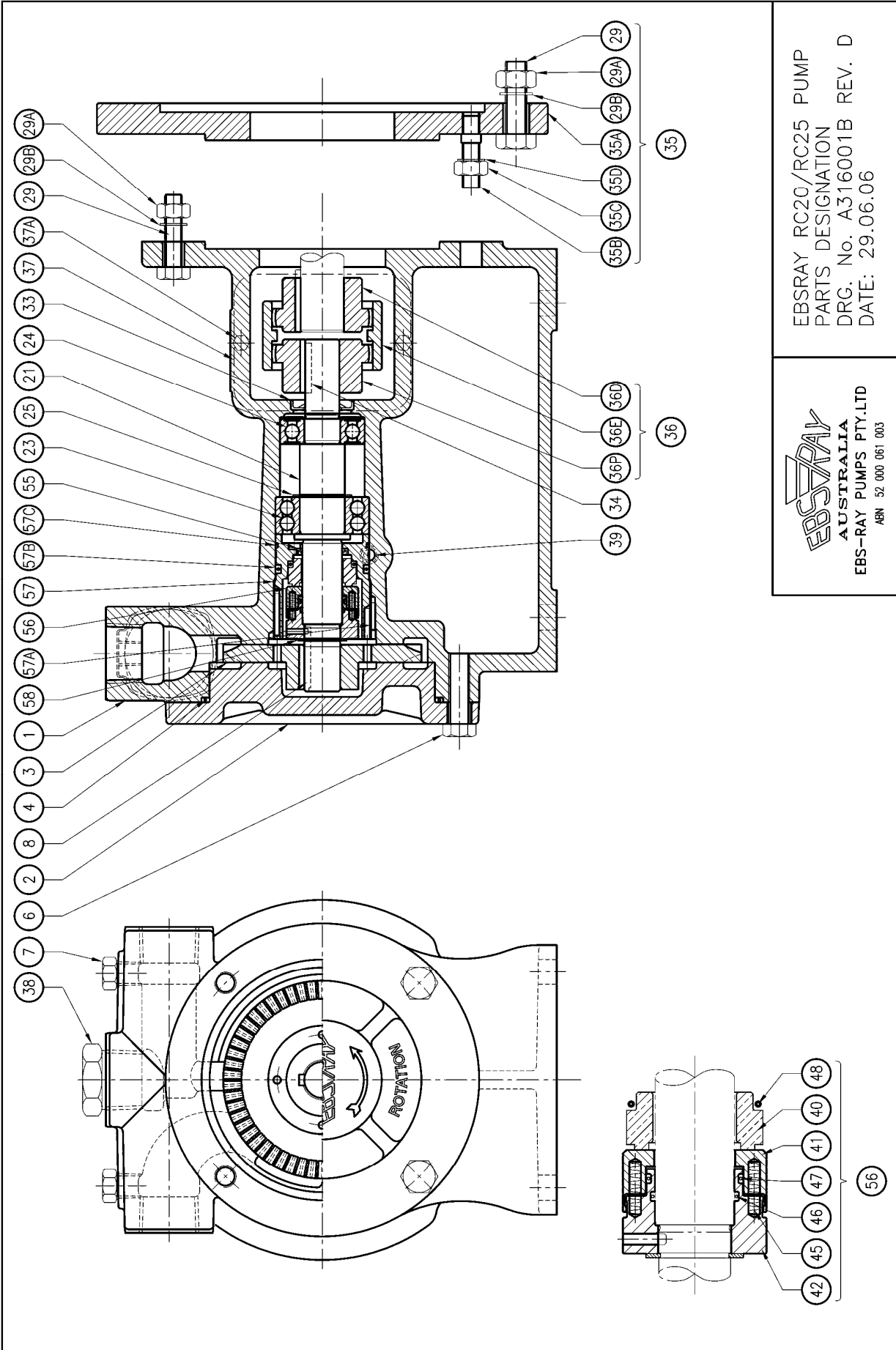

EBS-RAY RC20/RC25 PUMP
 PARTS DESIGNATION
 DRG. No. A316001B REV. D
 DATE: 29.06.06

EBS-RAY
 AUSTRALIA
 EBS-RAY PUMPS PTY.LTD
 ABN 52 000 061 003

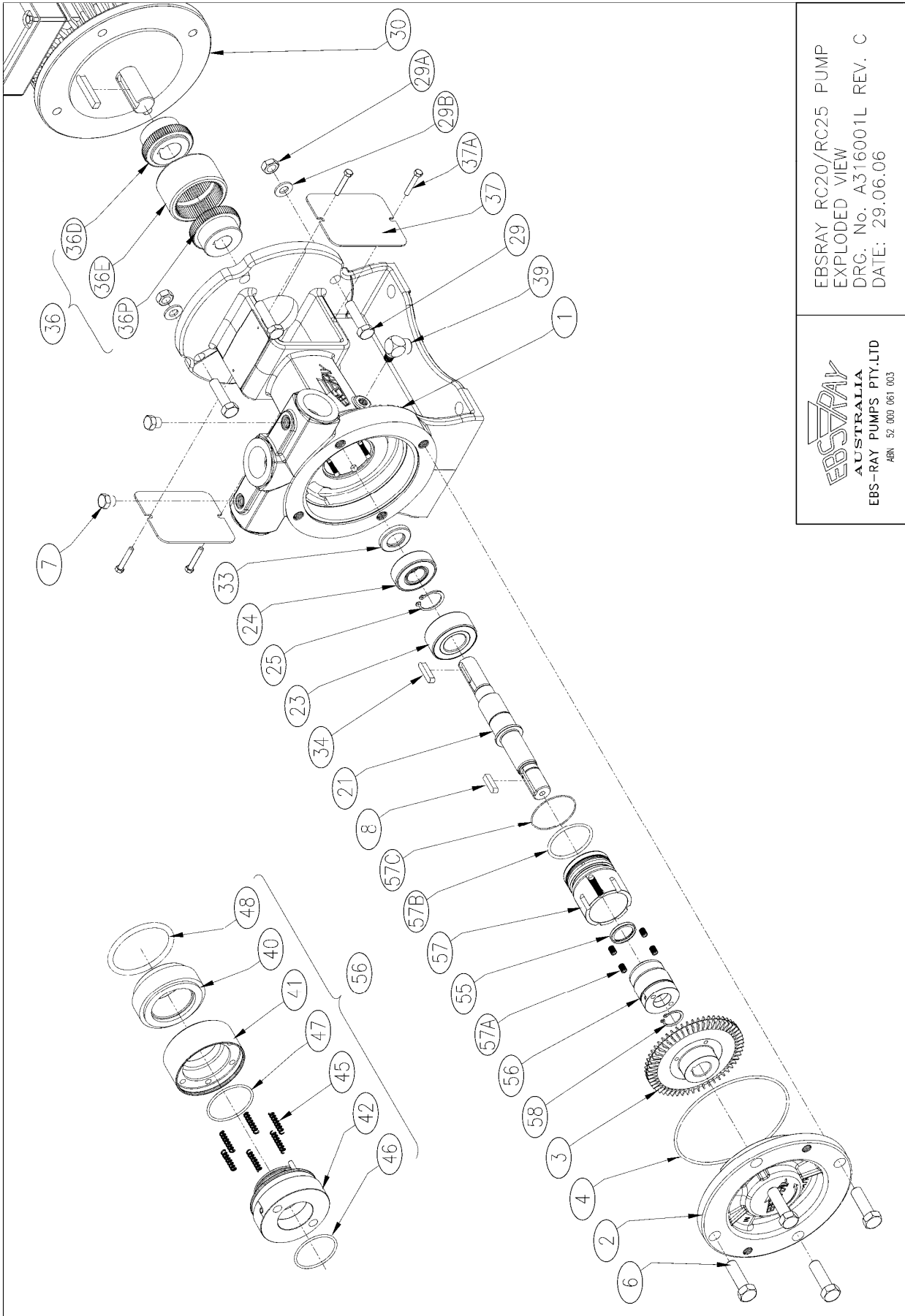

EBSRAY
 AUSTRALIA
 EBS-RAY PUMPS PTY.LTD
 ABN 52 000 061 003

EBSRAY RC20/RC25 PUMP
 EXPLODED VIEW
 DRG. No. A316001L REV. C
 DATE: 29.06.06

SECTION 7 - TROUBLE SHOOTING			
Symptom	Possible Problem	Possible Cause	Remedy
Pump running but will not generate adequate differential pressure	Pump not primed	Insufficient LPG in Storage tank	Fill Storage tank
		Inlet Valve not open	Open Inlet Valve
		Excessive heating (sun) on inlet piping and/or Pump	Cover Pump/piping with sunshade Paint Pump/piping white
		Pump unable to clear vapour due to excessive restriction in Bypass return-to tank line	Ensure unrestricted and fully open passage back to tank, clear blockage and/or restrictions
		Excessive volume of vapour to be cleared	Inlet (suction) pipe too long/too large – Shorten/reduce diameter
		Storage tank filling by tanker during dispensing/pumping operation	Wait until filling operation is completed and mix/temp/state has stabilised in tank
		Normal wear after extended service	Service Pump
	Incorrect pump rotation	Incorrect wiring to Motor	Reverse rotation by rewiring Motor
Pump will not run	Dispenser/Control/ Communications System faulty	Control System not providing signal	Repair Control System as required
	Power Supply faulty	Supply Power to Motor faulty	Check Power Supply
		Contact(s) or Coil in Motor Contactor faulty	Check Contactor, repair or replace as required
	No power to Motor	Motor Overload tripped out	Determine cause of trip-out before resetting
Jammed Pump	See Symptom 'Pump Motor using excessive power'		
Pump Motor using excessive power or over-heating	Differential Pressure too high	Incorrect Bypass Valve Setting.	Adjust (decrease) Bypass Valve setting to achieve required lower pressure.
		Discharge Valve not fully open	Open Discharge Valve
	Power Supply to Pump Motor faulty	Power Supply (incorrect voltage, phase imbalance or phase loss etc.)	Check Power Supply (with Pump running and with Pump stopped): a) To Main Switch Board b) To Pump Motor
	Pump jammed or damaged internally	Dirt/debris/contaminate from Storage Tank and/or inlet pipe	Clean blockage from Pump, Storage tank and/or inlet pipe before restarting Pump
		Impeller Damaged	Replace Impeller and inspect for damage to Body, Cover and Shaft.
Motor rapid cycling	Excessive starts per hour (refer motor manufacturer)	Inspect, repair or replace motor. Limit starts per hour	
Discharge Pressure too low	Differential Pressure too low	Insufficient LPG in Storage Tank	Fill Storage Tank
		Incorrect Bypass Valve setting.	Adjust (Increase) Bypass Valve setting to achieve required Differential Pressure.
		Bypass Valve jammed open or faulty	Check Bypass Valve, remove any obstruction, roughness, corrosion etc.
		Pump has 'Dead Headed' -Restriction in discharge system or Bypass line e.g. Discharge isolation valve, Bypass Valve, Bypass EFV or Isolation Valve closed	Check all devices in the discharge system and bypass line, remove blockage, repair or replace as required
		Excessive inlet (suction) restriction - Inlet Valve not opened fully - Blocked inlet strainer - Faulty Inlet Excess Flow Valve	Check / open Inlet Valve Clean strainer Check, repair or replace Inlet Excess Flow Valve as required
		Storage tank filling by tanker during dispensing/pumping operation	Wait until filling operation is completed and mix/temp/state has stabilised in tank
		Normal wear after extended service	Service Pump
		Discharge Valve not fully open	Open Discharge Valve
	Low vapour Pressure in Storage Tank	High% Butane in Storage tank	Increase Differential Pressure Increase Vapour Pressure

Symptom	Possible Problem	Possible Cause	Remedy	
No Tank/Vehicle fill	Pump operating (rotating) but fails to deliver LPG	Receiving Tank/Vehicle Tank already full	No problem exists	
		Insufficient LPG in Storage Tank	Fill Storage Tank	
		Blockage in Pump inlet/discharge line	Clear blockage e.g. open Valve, Excess Flow Valve, Valve at Dispenser etc.	
		Insufficient system Discharge Pressure (See Symptom "Discharge Pressure too low")	Increase Discharge Pressure (See Symptom "Discharge Pressure too low")	
		Excessive pressure in Receiving Tank/Vehicle Tank	Allow Receiving Tank/Vehicle Tank to cool until pressure decreases	
		Malfunctioning AFL Valve or blocked Filter in AFL Valve in Receiving Tank/Vehicle	Repair, clean filter or replace AFL Valve in Receiving Tank/Vehicle as required	
		Blocked Filter in Meter/Dispenser	Check and clean or replace as required	
		Blocked Filter in Nozzle	Check and clean or replace as required	
		Pump not primed with LPG	Refer to Symptom "Pump running but will not generate adequate differential pressure" Section of this manual	
		Storage tank filling by tanker during dispensing/pumping operation	Wait until filling operation is completed and mix/temp/state has stabilised in tank	
		Dispenser malfunctioning or not authorised correctly	Re-authorise or check Dispenser as required.	
Slow Tank/Vehicle fill	Low Pump flow	Insufficient LPG in Storage Tank - Pump Inlet (Suction) Port not fully covered with liquid	Fill Storage Tank	
		Excessive pressure in Receiving Tank/Vehicle tank	As filling proceeds, temperature (and pressure) will fall - increasing fill rate	
	Low Discharge Pressure	(See Symptom "Discharge Pressure too low")	(See Symptom "Discharge Pressure too low")	
		Restriction between Pumpset and Vehicle tank	Malfunctioning AFL Valve or blocked filter in AFL Valve in Receiving Tank/Vehicle	Repair, clean filter or replace AFL Valve in Receiving Tank/Vehicle as required
			Blocked filter in Meter/Dispenser	Check and clean or replace as required
			Blocked filter in Nozzle	Check and clean or replace as required
	Excessive System resistance to flow	Blockage within Receiving Tank/Vehicle's fill piping or Receiving Tank/Vehicle Back-check valve faulty	Clear blockage. Check, clean or replace as required	
		Long discharge line and/or small diameter	Increase diameter or increase differential pressure	
		Blocked filters in discharge system	Clean filters	
		High pressure drop equipment in discharge system (e.g. nozzle, dispenser, AFL valve, vehicle pipework)	Select 'lower loss' equipment	

Symptom	Possible Problem	Possible Cause	Remedy
Excessive Noise and/or Vibration	Obstruction in Pump	Dirt/debris/contaminate in Pump	Clean blockage from Pump, Storage tank and/or inlet pipe before restarting Pump
	Faulty EFV on inlet, Bypass or Discharge	EFV Spring faulty or EFV ports partially blocked	Check EFV(s), repair or replace as required
	Faulty Back-check Valve in Discharge Line	Inspect Back-check Valve: Spring, Seat, Poppet, Flapper etc.	Repair or replace Back-check Valve as required
	Faulty/noisy Bypass Valve	Bypass Valve faulty, worn or damaged	Check Bypass Valve, adjust, repair or replace as required
	Motor / Pump ball Bearings worn	Normal wear after extended service	Service Pump/motor
"Pulsing" flow or Pump losing prime	Pump cavitating or drawing vapour	Insufficient LPG in Storage tank - Pump Inlet (suction) Port not fully covered with liquid	Fill Storage tank
		Excessive Inlet (suction) restriction - Inlet Valve not opened fully - Faulty Inlet Excess Flow Valve - Blocked inlet strainer	Check / Open Inlet Valve, repair or replace Excess Flow Valve as required Clean strainer
		Pump has 'Dead Headed' - Restriction in discharge system or Bypass line e.g. Discharge isolation valve, Bypass Valve, Bypass EFV or Isolation Valve closed	Check all devices in the Discharge Line or the Bypass Line, remove blockage, repair or replace as required
	Worn Pump	Normal wear after extended service	Service Pump

APPENDIX A – TYPICAL INSTALLATION P&ID – (ABOVEGROUND)

IMPORTANT NOTES

- 1 This P&ID is **TYPICAL ONLY** and only relates to the specifications of the minimum equipment required to ensure the optimum performance, maximum life and trouble-free operation of the Ebsray RC20/RC25 Pumpsets and the pumping system in general.
- 2 This P&ID does **NOT** depict:
 - 2.1 Ancillary required equipment related to the fabrication, installation and operation of the Pumpset e.g. misc. flanges, fittings, etc...
 - 2.2 Required equipment unrelated to the Pumpset e.g. tank fill lines, vapour return lines, emergency shutdown systems, etc.
 - 2.3 The materials and method of fabrication and/or installation of the tank and required sub-systems.
- 3 It is the responsibility of the designer, fabricator and the installer of each actual tank and required sub-systems to ensure that:
 - 3.1 All design, fabrication and installation of the tank and required sub-systems is **STRICTLY** in accordance with all relevant Federal, State and Local Codes, Regulations and Standards.
 - 3.2 The Ebsray Specifications within this P&ID and any other relevant Ebsray Documents are **STRICTLY** adhered to.
 - 3.3 Any variation (including use of equipment deemed "equivalent") or addition to the Ebsray Specifications, as related to the Pumpset and the pumping system in general, meet Ebsray's minimum requirements.
- 4 Ebsray reserves the right to:
 - 4.1 Withdraw or alter any or all of the Ebsray Specifications within this P&ID and any other relevant Ebsray Documents without notification.
 - 4.2 Determine the validity of any warranty claims for Ebsray Equipment based on the proper application of Ebsray supplied equipment by the way of adherence to the Ebsray Specifications within this P&ID and any other relevant Ebsray Documents.

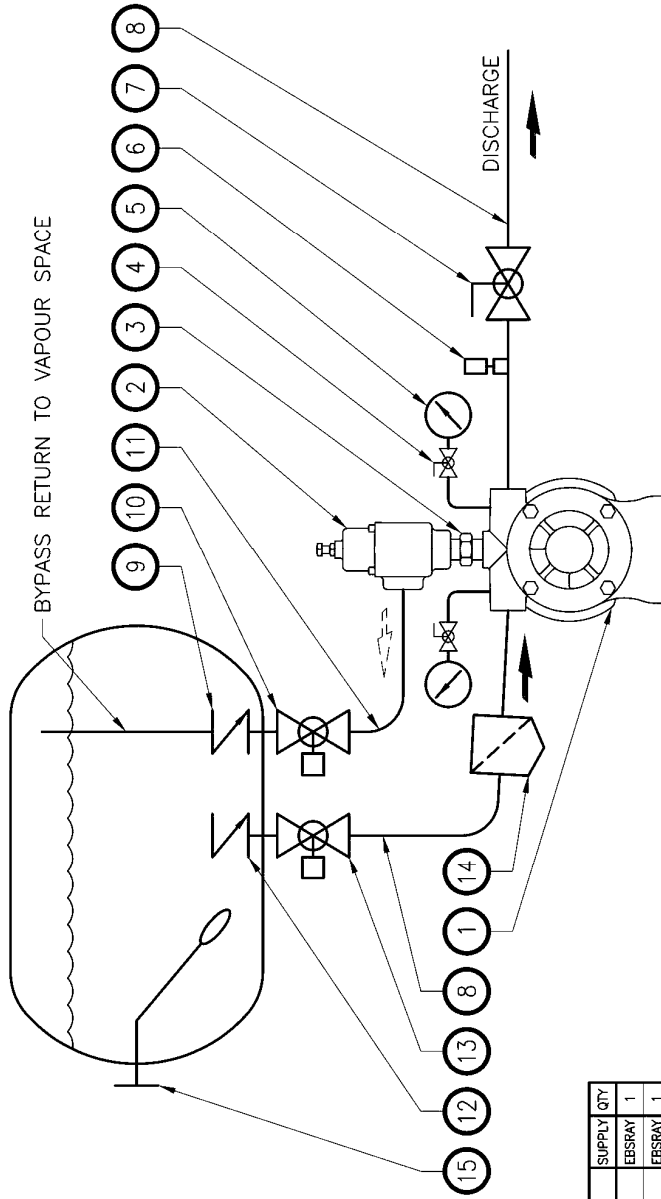

ITEM	DESCRIPTION	SUPPLY	QTY
1	EBSRAY RC20/RC25 PUMPSET THREADED 1" NPT INLET, DISCHARGE PORTS	EBSRAY	1
2	EBSRAY RV18 BYPASS VALVE THREADED 1" NPT (SEE TABLE)	EBSRAY	1
3	1" NPT SCHEDULE 80 HEX NIPPLE	EBSRAY	1
4	DN 8 ISOLATION VALVE	COM'L	2
5	63mm, 0-2500 kPa (0-25 BAR) PRESSURE GAUGE	COM'L	2
6	DN8 HYDROSTATIC RELIEF VALVE	COM'L	1
7	DN25 (MIN) BALL VALVE	COM'L	1
8	DN25 (MIN) SCHEDULE 80 PIPE (PUMP INLET AND DISCHARGE)	COM'L	1
9	EXCESS FLOW VALVE (BYPASS RETURN)	COM'L	1
10	DN20 (MIN) FULL BORE PNEUMATIC/SOLENOID ACTUATED BALL VALVE	COM'L	1
11	DN20 (MIN) SCHEDULE 80 PIPE (BYPASS RETURN TO TANK)	COM'L	1
12	EXCESS FLOW VALVE (PUMP INLET)	COM'L	1
13	DN25 (MIN) FULL BORE PNEUMATIC/SOLENOID ACTUATED BALL VALVE	COM'L	1
14	ADEQUATELY SIZED INLINE STRAINER	COM'L	1
15	LIQUID LEVEL GAUGE/ALARM	COM'L	1

EBSRAY MODEL - DUTY	EBSRAY BYPASS VALVE SELECTION	SUPPLY	QTY
RC20 - 50HZ	EBSRAY RV18CBS2	EBSRAY	1
RC20 - 60HZ	EBSRAY RV18VRS10 or RV18CBS2	EBSRAY	1
RC25 - 50HZ	EBSRAY RV18VRS14 or RV18CBS2	EBSRAY	1
RC25 - 60HZ	EBSRAY RV18VRS14 or RV18CBS2	EBSRAY	1



EBSRAY MODEL RC20/RC25 PUMPSET
TYPICAL SYSTEM INSTALLATION P&ID
DRG. No. A316001K REV. D
DATE: 07.11.06

EBS-RAY PUMPS PTY.LTD
4BN 52 000 061 003

APPENDIX B – SYSTEM PRE-STARTUP COMMISSIONING CHECKLIST

Date: _____ Pumpset Serial No. _____

Location: _____ Bypass Valve Model No / Serial No: _____

Installation Company: _____ Installer's Name: _____

Indicate Inspection Satisfactorily Completed with a in the appropriate box

- 1. Check for leak free installation at Pump and pipe connections.
- 2. Check for correct pipe/port orientation (check IN / OUT marking on Pump).
- 3. Ensure voltage is correct and that all relevant electrical components are adequate for the application.....
- 4. Ensure motor overload relay setting does not exceed FLA of motor



WARNING

***Do not run Pump in reverse.
Severe internal damage to the Pump may result.***

- 5. Direction of rotation –
 This **MUST** be tested prior to Pump operation (check marking on Pump)



WARNING

***Do not run Pump dry.
Severe internal damage to the Pump will result, voiding Warranty.***

- 6. Valves should be in the following positions:
 (see Appendix A – P&ID for locations)
- Pump Inlet Valve.....OPEN.....
- Valves to both Pressure GaugesOPEN.....
- Discharge Line Valve/s.....OPEN.....
- Vapour/Bypass Return Line Valve/sOPEN.....



WARNING

***Do not start Pump against closed Discharge Valve or
with Inlet Valve closed or throttled***

- 7. Ensure Storage Tank has adequate liquid and Pump is liquid filled before starting motor.....
- 8. Back off Bypass Valve Adjusting Screw fully i.e. Minimum differential pressure.....

Notes:

APPENDIX D – DECLARATION OF CONFORMITY



Publication No 2011-05

EC DECLARATION OF CONFORMITY

Item	Content based upon Annex X of ATEX Directive 94/9/EC
Manufacturer	Ebsray Pumps Pty Ltd
Address	628 Pittwater Road Brookvale NSW 2100 Australia
Manufacturer's Declaration	We, Ebsray Pumps Pty Ltd declare that the following equipment :
Description of Equipment	Ebsray R Series Regenerative Turbine bareshaft Pump ; Model / Type : RC20 (all Types) RC25 (all Types) R10 (all Types) RB10 (all Types) for pumping LPG and other light liquids ; and bearing the following marking :
Declaration of compliance	Is designed and manufactured in compliance with the following applicable Directives :
Applicable Directives evaluated by Manufacturer - not checked by Notified Body	
First applicable Directive 1. Individual declaration of compliance	ATEX Directive 94/9/EC - by application of the following Standards : EN 1127-1 (1998) EN 13463-1 (2001) EN 13463-5 (2003)
Second applicable Directive	Pressure Equipment Directive (PED) 97/23/EC - but excluded under Article 3.10
Third applicable Directive	Machinery Directive (MD) 98/37/EC – by application of the following Standards : EN ISO 12100-1 (2003) EN ISO 12100-2 (2003) EN 809 (1998)
Manufacturer's own warning	Subject to the use for which the product(s) were designed and/or installed in accordance with the relevant Standards and Codes – all in conjunction with the Manufacturer's own Installation and Operating Instructions and recommendations
Final declaration	We, the undersigned, hereby declare that the product(s) specified conform to the listed Directive(s) and Standard(s)
Signatory of person legally responsible	Ebsray Pumps Pty Ltd W.A.Ebsary - Managing Director
Place / Date	Brookvale, Australia / 10 September 2004



Publication No 2041-05

EC DECLARATION OF CONFORMITY

Item	Content based upon Annex X of ATEX Directive 94/9/EC
Manufacturer	Ebsray Pumps Pty Ltd
Address	628 Pittwater Road Brookvale NSW 2100 Australia
Manufacturer's Declaration	We, Ebsray Pumps Pty Ltd declare that the following equipment :
Description of Equipment	Ebsray Polygear Series Mechanical Shaft Coupling ; Model / Size / Type : 575 (all Sizes) (all Types) for pumps in LPG and other liquid service ; and bearing the following marking :
Declaration of compliance	Is designed and manufactured in compliance with the following applicable Directives :
Applicable Directives evaluated by Manufacturer - not checked by Notified Body	
First applicable Directive 1. Individual declaration of compliance	ATEX Directive 94/9/EC - by application of the following Standards : EN 1127-1 (1998) EN 13463-1 (2001) EN 13463-5 (2003)
Second applicable Directive	Machinery Directive (MD) 98/37/EC – by application of the following Standards : EN ISO 12100-1 (2003) EN ISO 12100-2 (2003)
Manufacturer's own warning	Subject to the use for which the product(s) were designed and/or installed in accordance with the relevant Standards and Codes – all in conjunction with the Manufacturer's own Installation and Operating Instructions and recommendations
Final declaration	We, the undersigned, hereby declare that the product(s) specified conform to the listed Directive(s) and Standard(s)
Signatory of person legally responsible	Ebsray Pumps Pty Ltd W.A.Ebsary - Managing Director
Place / Date	Brookvale, Australia / 10 September 2004

NOTES