

REV.	DESCRIPTION	BY	CHK.	APP.	DATE
A	RELEASED INTO PRODUCTION SEE ECN #GRT001328	-	-	-	-

NOTES: UNLESS OTHERWISE SPECIFIED

- DIMENSIONS AND TOLERANCES PER ASME Y14.5M-1994.
- * INDICATES DIMENSIONS AND/OR FEATURES MODIFIED ON CURRENT REVISION LEVEL.

 DIMENSIONS REFLECT STANDARD MFG TOLERANCES.

 WEIGHTS ARE APPROXIMATE AND MAY VARY BASED ON MANUFACTURER'S MATERIALS AND PUMP CONFIGURATION.

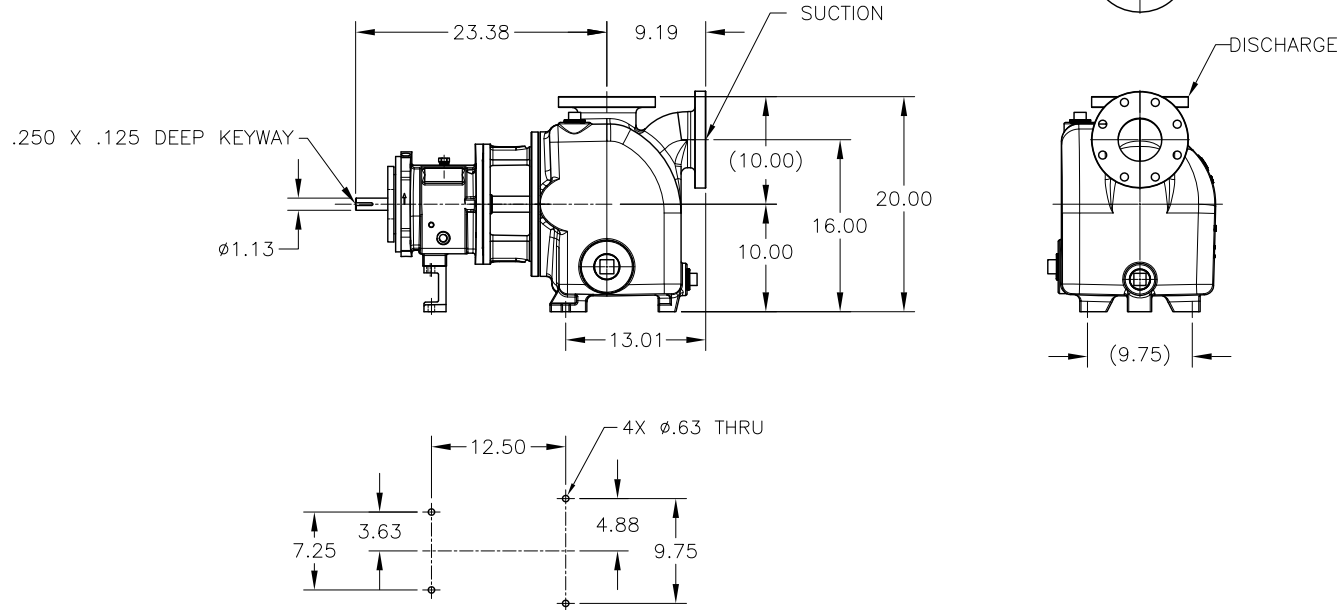

**CERTIFIED
FOR
CONSTRUCTION**

ONLY WHEN SIGNED

Signature _____
Date _____
Customer _____
Customer P.O. # _____

OPTION ✓	AVAILABLE OPTIONS
	PUMP MATERIAL
	X4 CD4MCU SS
	OTHER
	FLANGE FACE
	FLAT FACE
	RAISED FACE

FLANGE OPTION DIMENSIONS

OPTION ✓	NOMINAL PIPE SIZE	FLANGE DIAMETER	BOLT CIRCLE DIAMETER	NO. OF BOLTS	DIAMETER OF BOLTS	BOLT HOLE	FLANGE
	4" ASME 150# (SHOWN)						DISCHARGE
	4.00	9.00	7.50	8	0.63	0.75	
	4" ASME 150# (SHOWN)						SUCTION
	4.00	9.00	7.50	8	0.63	0.75	
	4" ASME 300#						DISCHARGE
	4.00	10.00	7.88	8	0.75	0.88	
	4" ASME 300#						SUCTION
	4.00	10.00	7.88	8	0.75	0.88	

 PUMP WT. - 450 LBS

DO NOT SCALE DRAWING UNLESS OTHERWISE SPECIFIED DIMENSIONS ARE IN INCHES TOLERANCES ARE:	
DECIMALS .XX ± -	
.XXX ± -	
ANGLES ± -	
SCALE 1/8	SHEET 1 OF 1



GRISWOLD PUMP COMPANY
22060 VAN BUREN STREET
GRAND TERRACE, CA 92313-9007
PHONE: (909) 642-2222 / (209) 526-5355
WWW.GRISWOLDPUMP.COM

TITLE 4 x 4 - 10, 811SP PEO, MD PF			
DRAWN BY R. ANDRADE	DATE 03/05/21	ASSY. NO.	
CHECKED BY T. VOVAN	DATE 03/09/21	DRAWING NO.	
APPROVED BY R. BEACH	DATE 3/30/21	REV.	LG1879 A