



Micro C Series Chemical Eccentric Disc Pump

Seal-less Design

The Unique seal-less design features a Stainless Steel bellows which ensures durability, safety and product containment. The Micro C Series provides very high suction and discharge pressures which allows it to selfprime and fully strip lines, maximizing product recovery.

Run Dry Capability

The Micro C can run dry for up to 5 minutes, and the self-compensating eccentric disc principle provides consistent flow rates over a long period of time. The flow rate is extremely accurate even at low speeds.

Dependable

There are fewer moving parts, which results in reduced maintenance and downtime.

Advantages:

- Eccentric Disc design allows for consistent flow and improved energy savings
- Extremely gentle, pulse-free flow to protect shear-sensitive products
- Reduced maintenance with no mechanical seals or timing gears
- Easy to install

Options:

- DIN 11851: DN20 / 3/4"
- BSP/NPT: DN15 / 1/2"
- SMS: DN25 / 1"
- DIN 32676 Clamp: DN20 / 3/4"
- ISO Clamp: DN25 / 1"
- ASME - BPE Clamp: DN25 / 1"
- Mobile-mounted

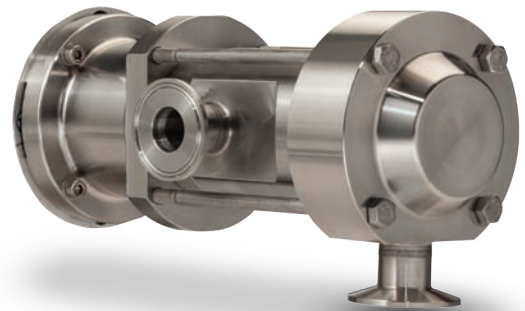



Micro C Series Chemical Eccentric Disc Pump



Operation:

- Principle: Eccentric Disc, positive displacement
- Installation: Can be base mounted or cart mounted for mobility

Construction:

- All Stainless Steel construction
- Shaft sealed by Stainless Steel bellows
- Ra 0.8 µm (32 µ inch) wetted surfaces

Features & Benefits:

- Seal-less design eliminates leakage
- Ability to strip and drain transfer piping/tubing
- Line-stripping capabilities
- Self-priming
- Strong Suction and Discharge Pressure
- Shear-sensitive handling
- Consistent flow rate independent of pressure
- Low linear speed
- Precise dosing
- Accurate volume metering with high turn down
- Dry-run capable
- Maintains performance over time
- Effective with both high- and low-viscosity fluids
- Full drainability
- Easy integration

Applications:

Plastics

- Transfer and dosing isocyanates, d'amines, MDI, TDI
- Injection polyuréthane, polyols
- Dosing additives (carbon, mineral fillers)

Paint and inks

- Transfer and dosing water based paints, pigments, catalyst, colorings, inks, hardener, printing process

Papers

- Injection glue, additives, resins

Other applications

- Injection additives
- Biofuel production units
- Bitumen production units
- Chemical formulations



Mouvex Technology

Eccentric disc pumps consist of a cylinder and pumping element mounted on an eccentric shaft. As the eccentric shaft is rotated, the pumping element forms chambers within the cylinder, which increase in size at the intake port, drawing fluid into the pumping chamber. The fluid is transported to the discharge port where the pumping chamber size is decreased. This action squeezes the fluid out into the discharge piping.

Mouvex Principle

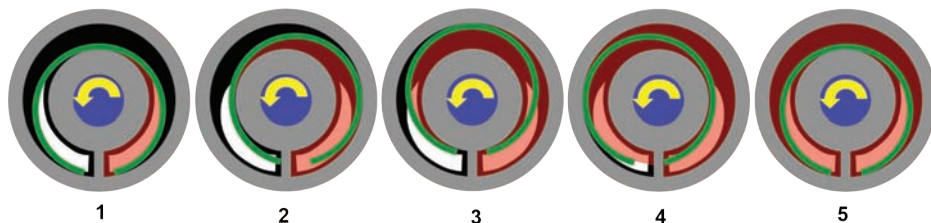

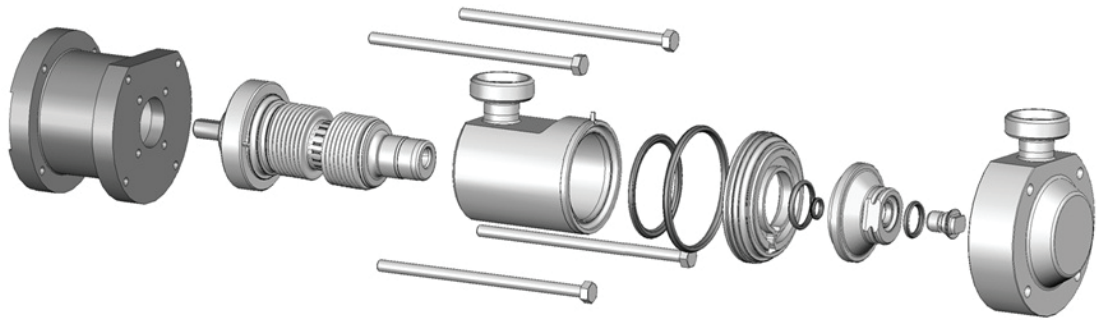

Performance Data

Model	Max. Speed	Max. Flow Rate	Max. Diff. Pressure
Micro C 125	1000 rpm	125 l/h	15 bar
		0.55 GPM	217 psi
Micro C 250	1000 rpm	250 l/h	10 bar
		1.1 GPM	145 psi
Micro C 500	1000 rpm	500 l/h	5 bar
		2.2 GPM	72 psi
Micro C 800	1000 rpm	800 l/h	3 bar
		3.52 GPM	43 psi

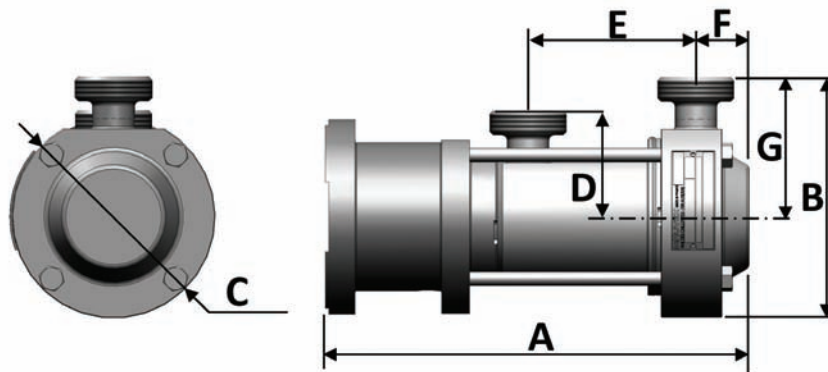

Dimensions*

		MC125	MC250	MC500	MC800
A	mm (in.)	242.5 (9.55)			
B	mm (in.)	138 (5.43)			
C	mm (in.)	116 (4.57)			
D	mm (in.)	61 (2.39)			
E	mm (in.)	96 (3.78)			
F	mm (in.)	30.5 (1.20)			
G	mm (in.)	80 (3.15)			
Weight	kg (lbs.)	8 (17.7)			

* With DIN 11851 Connections

Where Innovation Flows



ZI la Plaine des Isles • 2 rue des Caillottes

F-89000 AUXERRE - FRANCE

T: + 33.3.86.49.86.30

F: + 33.3.86.46.42.10

contact@mouvex.com

mouvex.com

Authorized PSG Partner: