



IMPORTANT! | IMPORTANT! | WICHTIG! | ¡IMPORTANTE!

Thoroughly review the manual, all instructions, and hazard warnings **BEFORE** installing, using, and performing any maintenance on the compressor.

EN

Manuals are available for download using the QR code and at mouvex.com.

Attempting installation, operation, and disassembling/reassembling of the compressor without reading and following manual instructions could lead to **SAFETY** risks and **irreparable DAMAGES** to the compressor.

FR

Lisez attentivement le manuel, toutes les instructions et les avertissements de danger **AVANT** l'installation, l'utilisation et l'entretien du compresseur.

Les notices sont disponibles par téléchargement, Utilisez le QR code et sur le site internet mouvex.com.

Tenter d'installer, d'utiliser et de démonter/remonter le compresseur sans lire et suivre les recommandations de la notice peut conduire à des **risques en termes de SECURITE** et des **DOMMAGES IRRÉVERSIBLES** sur le compresseur.

DE

Lesen Sie das Handbuch mit allen Anweisungen und Gefahrenhinweisen **VOR** der Installation, der Nutzung und der Durchführung von Wartungsarbeiten an dem Kompressor gründlich durch.

Handbücher stehen zum Download über den QR-Code und unter mouvex.com zur Verfügung.

Die Installation, der Betrieb, der Abbau bzw. Aufbau des Kompressors ohne vorheriges gründliches Lesen und das Befolgen der Anweisungen des Handbuches kann zu **SICHERHEITSRISIKEN** und **irreparablen SCHÄDEN** an dem Kompressor führen.

ES

Revise a fondo el manual, todas las instrucciones y advertencias de peligro **ANTES** de instalar, de utilizar o de realizar cualquier mantenimiento en el compresor.

Los manuales se pueden descargar usando el código QR y en mouvex.com.

Intentar instalar, hacer funcionar o desmontar / remontar el compresor sin leer y seguir las instrucciones de los manuales podría generar **riesgos de SEGURIDAD** y **DAÑOS** irreparables para el compresor.

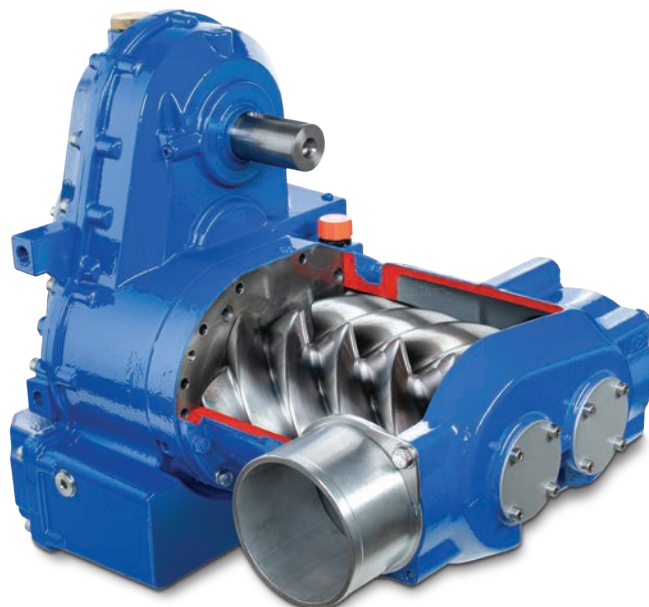



Quick Start Guide | SCREW COMPRESSORS

QUICK START GUIDE | *GUIDE DEMARRAGE RAPIDE* | SCHNELLSTARTANLEITUNG | *GUÍA DE INICIO RÁPIDO*

MX12

Position | *Position* | Position | *Posición*

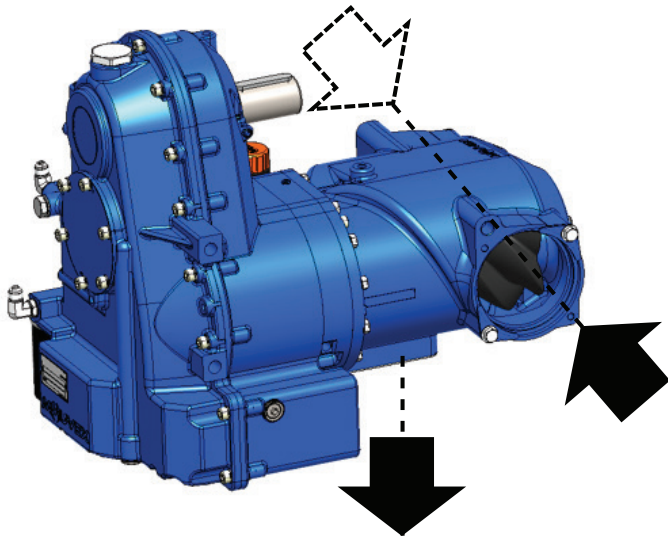

S Version

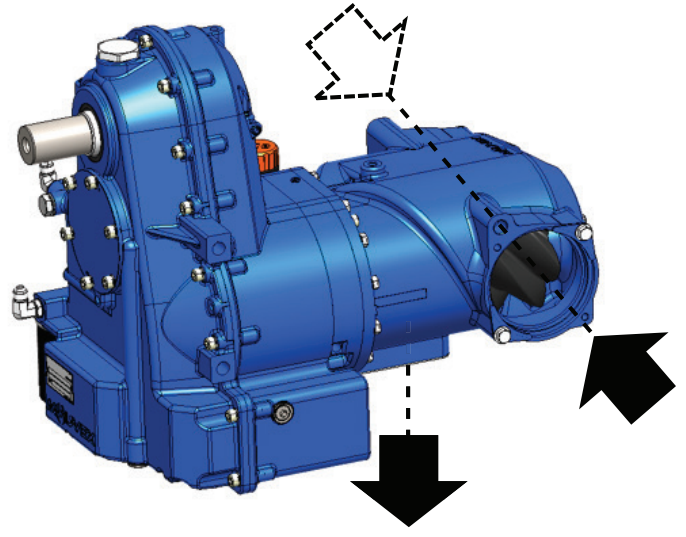

N Version

Direction Rotation | *Sens de Rotation* | Drehrichtung | *Sentido de giro*

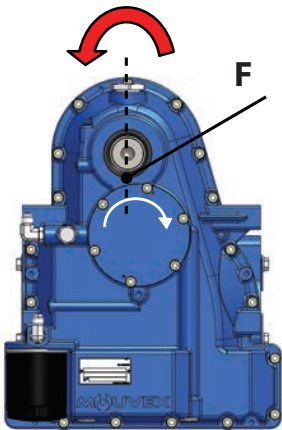
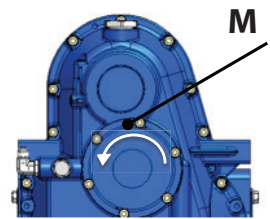
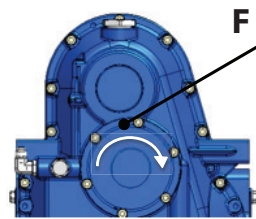

15L / 20L

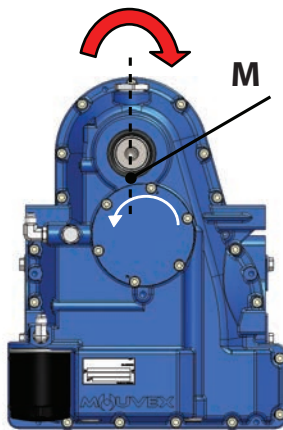

18R / 24R

N Version

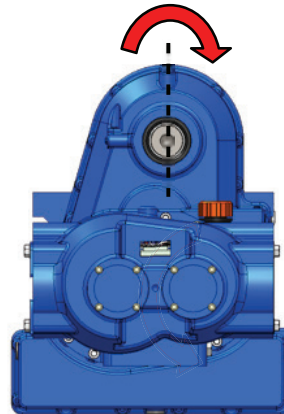

15R / 20R

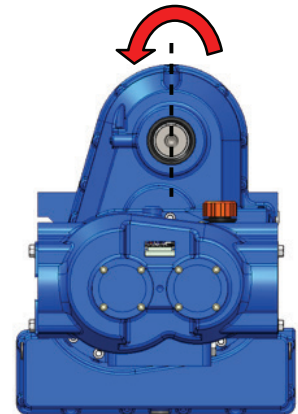

18L / 24L

S Version



Quick Start Guide | SCREW COMPRESSORS

QUICK START GUIDE | GUIDE DEMARRAGE RAPIDE | SCHNELLSTARTANLEITUNG | GUÍA DE INICIO RÁPIDO

MX12

Transmission | Transmission | Übertragung | Transmisión

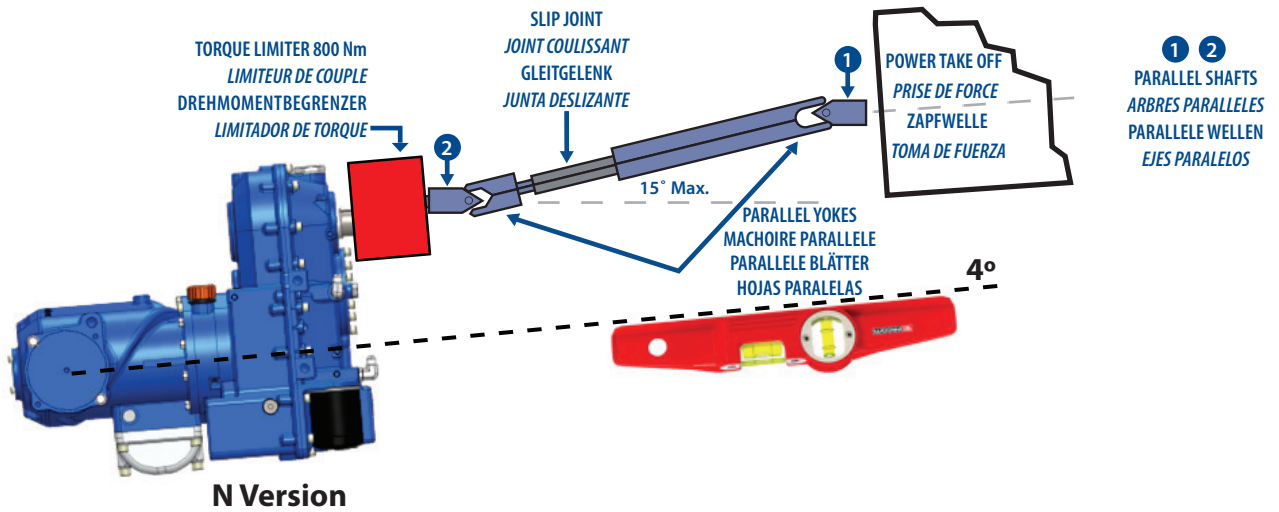
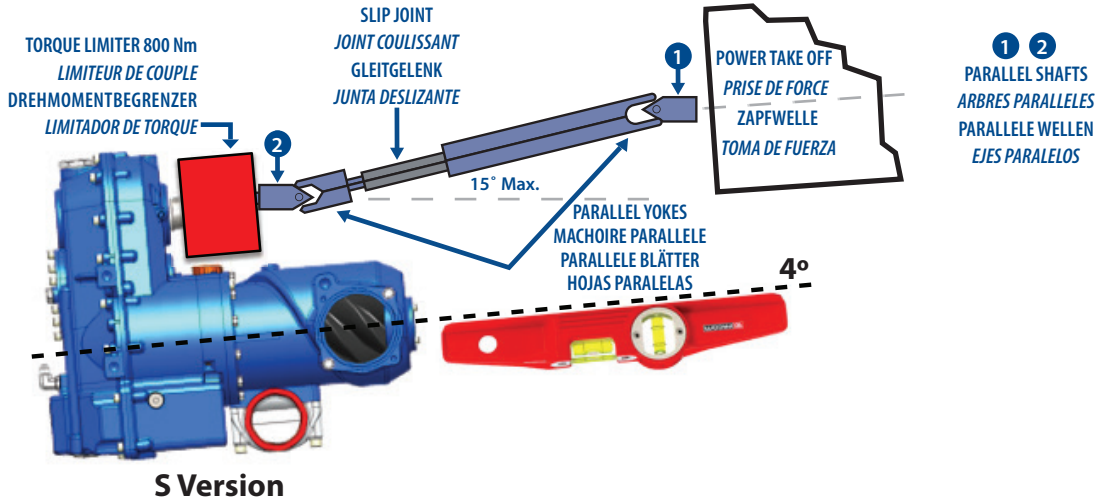

Oil Cooler | Radiateur d'huile | Ölkühler | Enfriador de aceite

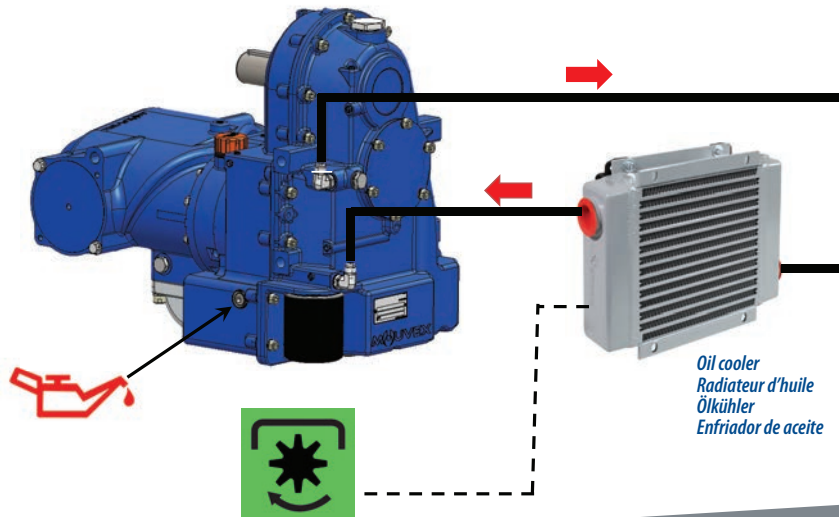



Quick Start Guide | SCREW COMPRESSORS



QUICK START GUIDE | GUIDE DEMARRAGE RAPIDE | SCHNELLSTARTANLEITUNG | GUÍA DE INICIO RÁPIDO

MX12

Suction Line | Ligne d'aspiration | Saugleitung | Línea de succión

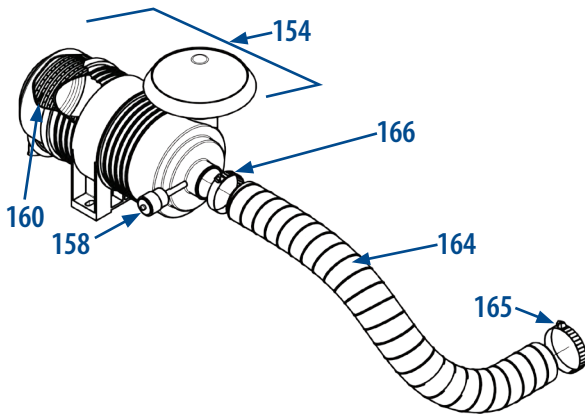

Hose adjusted to the installation, clean inside (164)
Clamps in place and tightened (165-166)

Flexible ajusté à l'installation, propre à l'intérieur (164)
Colliers en place et serrés (165-166)

Schlauch an die Installation angepasst, innen rein (164)
Klammern an Ort und Stelle festgezogen (165-166)

Manguera ajustada a la instalación, limpia adentro (164)
Abrazaderas en su lugar y apretadas (165-166)

Discharge Line | Ligne de Refoulement | Entladungsleitung | Línea de descarga

Speed | Vitesse de | Geschwindigkeitsdrehung | Rotación de
Rotation | Rotation | Drehung | velocidad

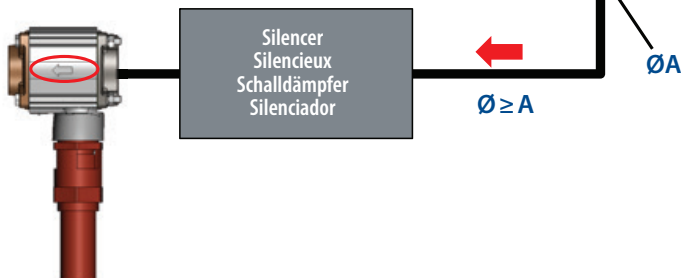
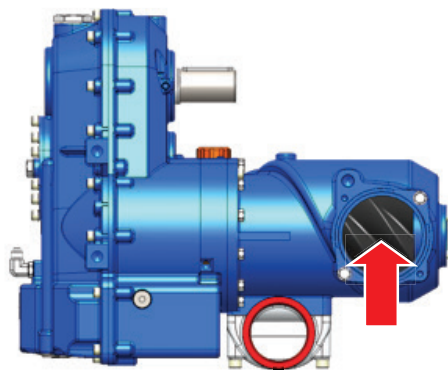

Model	Minimum tr/min - rpm	Maximum tr/min - rpm
15 R/L	1151	1439
18 R/L	1382	1727
20 R/L	1536	1920
24 R/L	1843	2305



ZI la Plaine des Isles • 2 rue des Caillottes
F-89000 AUXERRE - FRANCE
Tel: + 33.3.86.49.86.30 • Fax: + 33.3.86.46.42.10
contact.mouvex@psgdover.com

mouvex.com

© 2020 MOUVEX

EN English FR Français DE Deutsch ES Español