



INSTRUCTIONS 1003-A00 e

Section	1003
Effective	March 2023
Replaces	September 2018

Original instructions

AZ PUMP

Construction O



INSTALLATION

OPERATION

MAINTENANCE

EC CERTIFICATE OF CONFORMITY :

The EC Certificate of Conformity (paper version) is systematically attached to the equipment when shipped.

WARRANTY :

A Series pumps are covered 24 months by warranty within the limits mentioned in our General Sales Conditions. In case of a use other than that mentioned in the Instructions manual, and without preliminary agreement of MOUVEX, warranty will be canceled.



Z.I. La Plaine des Isles - F 89000 AUXERRE - FRANCE
Tel. : +33 (0)3.86.49.86.30 - Fax : +33 (0)3.86.49.87.17
contact.mouvex@psgdover.com - www.mouvex.com

Your distributor :

ECCENTRIC PISTON PUMP

MOUVEX PRINCIPLE

SAFETY, STORAGE, INSTALLATION AND MAINTENANCE INSTRUCTIONS

MODEL : AZ O

USED PRESSURE UNITS

Unit without suffix :

Differential pressure, for example, pressure difference between equipment suction and discharge.

Unit with suffix "a" :

Absolute pressure.

Unit with suffix "g" :

Gauge pressure, given regarding to atmospheric pressure (~101325 Pa, taken at 1 bar / 14,5 psi in this IOM).

Example :

$P_{suc} = -0,2 \text{ barg} = 0,8 \text{ bara}$

$P_{dis} = 8,8 \text{ barg} = 9,8 \text{ bara}$

$\Delta P = P_{dis} - P_{suc} = 9 \text{ bar}$

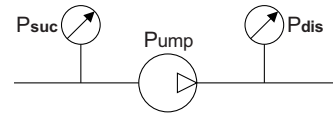

TECHNICAL CHARACTERISTICS

- Construction : Cast iron and steel
- Maximum suction pressure : less than 1 barg
- Acceptable maximal differential pressure : 5 bar
- Maximum pump speed : 1500 rpm
- Operating temperature : -15°C to +150°C
- Cylinder capacity : 0,014 litre

Definition of safety symbols



This is a SAFETY ALERT SYMBOL.

When you see this symbol on the product, or in the manual, look for one of the following signal words and be alert to the potential for personal injury, death or major property damage.



Warns of hazards that **WILL** cause serious personal injury, death or major property damage.



Warns of hazards that **CAN** cause serious personal injury, death or major property damage.



Warns of hazards that **CAN** cause personal injury or property damage.

NOTICE

Indicates special instructions which are very important and must be followed.

TABLE OF CONTENTS

Page

1. OVERALL DIMENSIONS	3
2. INSTALLATION	4
2.1 Choice of pump	4
2.2 Piping diameters	4
2.3 Piping assembly	4
2.4 Direction of rotation	4
2.5 Bypass	5
2.6 Cleaning	5
2.7 Anchoring the pump units	5
2.8 Alignment of motor / pump and reduction gearbox / pump shafts	5
2.9 Electric motors	6
2.10 Diesel engine drive	6
2.11 Belt drive transmission	6
3. USE	7
3.1 Storage	7
3.2 Pumping hot products	7
3.3 Pump filled with product at shutdown	7
3.4 Starting-up the pump	7
3.5 Shutting down the pump	7
3.6 Restarting	7
4. OPENING THE PUMP TO INSPECT THE CYLINDER/ PISTON AND BUSHINGS	8
4.1 Necessary tools	9
4.2 Disassembly for inspection	9
4.3 Reassembly	9
5. MONODIR MECHANICAL SEAL	10
5.1 Operation	10
5.2 Disassembly	10
5.3 Reassembly	10
6. BYPASS	11
6.1 Operation	11
6.2 Orientation	11
6.3 Inversion	12
6.4 Adjustment	12
6.5 Obtaining the flow	13
6.6 Energy consumption	13
6.7 Bypass use	13
7. MAINTENANCE	14
7.1 Greasing	14
7.2 Checking of parts	14
8. DRILLED PISTON PUMP	14
9. STORAGE	15
9.1 Short duration (≤ 1 month)	15
9.2 Long duration (> 1 month)	15
10. SCRAPPING	15
11. TROUBLESHOOTING	16

1. OVERALL DIMENSIONS

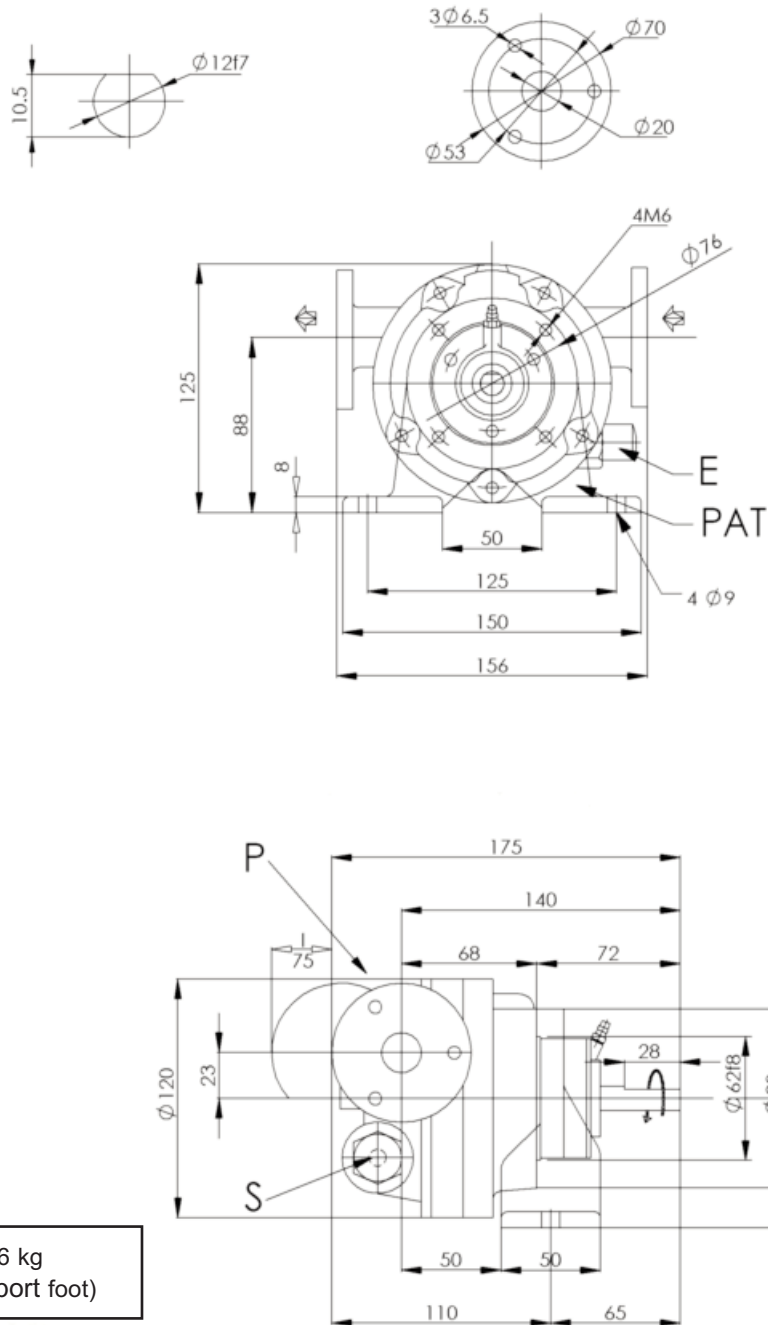

Weight : 6 kg
(7 kg with support foot)

E	Bypass valve.
I	Space required for removing pump.
P	Pump plate.
PAT	Support foot pump.
S	Mounting point for probe : M6 - threaded width : max. 8 mm.

The pump can be delivered with support foot pump or not to be flanged.

The pump can be fixed in any position.

Chain or belt drive.

Shaft end supported by ball-bearing.

Place pulley as near as possible to ball-bearing.

Noise level

The sound level of a pump is greatly influenced by its conditions of use. Cavitation and pumping products with high gas contents generally increases the sound level.

Under the following pumping conditions :

- excluding cavitation
- discharge pressure : 5 bar
- speed of rotation 1500 rpm
- product viscosity of 1 cSt

The sound level reached for the AZ pump in good conditions (ignoring the motor and gearbox noise) is less than 77 dB(A).

2. INSTALLATION

2.1 Choice of pump

To obtain the service expected from a MOUVEX pump, regarding both performance and longevity, it is vital that the type of pump, its speed and the materials used for its construction are determined as a function of the pump output, its installation and operating conditions.

You can contact our Technical Services at any time to ask for the information you require.

2.2 Piping diameters



The location of the pump in the transfer or recycling circuit should always be determined so as to reduce the suction height and length of the piping as much as possible.

The diameter of the pipes must be determined as a function of their length on the one hand, and the flow and viscosity of the product on the other, so that head loss remains within design limits. Therefore it is difficult to give general and precise directions.

However, we recall that it is never prejudicial to plan for wide piping diameters, particularly regarding the intake.

For the discharge, it is also possible to plan for a diameter equal to that of the pump's orifices, and on the intake, for a wider diameter if suction is very strong. In the case of viscous products, the determination of this diameter is very important since the variation of head loss is proportional to the viscosity and inversely proportional to the power of 4th of the diameter. Therefore a small reduction of piping diameter can have major consequences. Our Technical Services are always available to provide you with precise data if you give them accurate information or, better still, the installation plans.

2.3 Piping assembly

	WARNING
	FAILURE TO RELIEVE THE SYSTEM PRESSURE PRIOR TO PERFORMING ANY WORK ON THE PUMP OR THE INSTALLATION CAN CAUSE PERSONAL INJURY OR PROPERTY DAMAGE.
Hazardous pressure can cause personal injury or property damage.	

Wherever possible, siphons and reverse slopes in the suction piping must be avoided and all the gaskets must be installed with great care to avoid air from entering the piping.

The elbows must always have a large radius and must not be assembled too close to the pump flanges, at the inlet as well as the outlet side.

A straight pipe 5 diameters is recommended between the pump flange and any pipe fitting (elbow, valve...).

The stresses exerted by the piping on the pump can deform the pump parts, increase wear, misalign the bearings and even cause parts to break.

The pipes must be designed to allow thermal expansion and contraction and be firmly secured (the use of flexible hoses and expansion loops is recommended).

For hoses fitting on pump suction or discharge, a hose whip restrain device must be installed to limit the whip or travel of the pressurized hose at start up, or in case the hose breaks free.

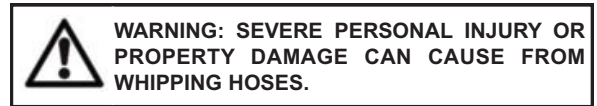

We recommend placing isolating valves close to the pump flanges to permit dismantling and replacement without having to drain the installation. These valves should have the same diameter as the pipes and, by preference, be a full bore model.



A strainer should be fitted in the suction line to prevent the introduction of foreign bodies into the pump.

Before installing the new piping and tanks, clean them carefully to remove welding waste, rust, etc., which when carried by the liquid may damage the pump.

If the liquid may freeze or solidify, prepare for draining the piping by installing drain taps at the low points and air vents at the high points.

In the case of a very high intake or if you wish to prevent the piping from emptying at shutdown, you can install a foot valve. It should have a large diameter so as not to generate additional head loss.

2.4 Direction of rotation

	WARNING
	FAILURE TO RELIEVE THE SYSTEM PRESSURE PRIOR TO PERFORMING ANY WORK ON THE PUMP OR THE INSTALLATION CAN CAUSE PERSONAL INJURY OR PROPERTY DAMAGE.
Hazardous pressure can cause personal injury or property damage.	

The MOUVEX pump is reversible; this allows it to always circulate the liquid in the desired direction by choosing the corresponding direction of rotation.

The intake and discharge sides are determined as follows :

When an observer faces the shaft, if rotation takes place clockwise, the intake is on the right; on the contrary if the rotation is anticlockwise, the intake is on the left.

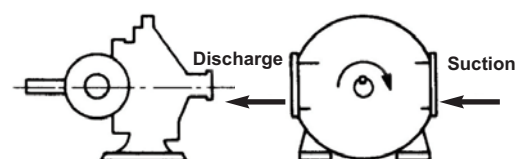



Figure A - Clockwise rotation



2. INSTALLATION (continued)

2.5 Bypass

 WARNING	<p>FAILURE TO RELIEVE THE SYSTEM PRESSURE PRIOR TO PERFORMING ANY WORK ON THE PUMP OR THE INSTALLATION CAN CAUSE PERSONAL INJURY OR PROPERTY DAMAGE.</p>
	
<p>Hazardous pressure can cause personal injury or property damage.</p>	

The bypass protects only the pump in only one direction, but it is reversible. Cap A must be on the intake side. This must be done before the pump is started for the first time and re-validated if the pumping circuit changes.



 WARNING	<p>IF PUMPING HAZARDOUS OR TOXIC FLUIDS, THE SYSTEM MUST BE FLUSHED PRIOR TO PERFORMING ANY SERVICE OPERATION.</p>
	
<p>Hazardous or toxic fluids can cause serious injury.</p>	

Once the pump is drained, the single bypass can easily be changed to the correct direction by dismantling the screws of the fastening pins and by turning the bypass 180° : before locking it in its new position, make sure that you carefully install the seals beneath it.

2.6 Cleaning

Since the pumps are delivered well greased, they must be cleaned before starting them up (especially when transferring food products, for example).

Cleaning can be done either by circulating an appropriate liquid, or by removing the front cover of the pump and carefully cleaning the internal parts. (cf. § OPENING THE PUMP).

2.7 Anchoring the pump units

The correct seating of the pump unit is vital for its efficient operation and its longevity.



The surface must be resistant enough to absorb the stresses due to the pump unit without deformation.



In the case where the unit is fastened by anchor lugs or bolts, it must be carefully wedged to prevent any deformation of the chassis when tightening the bolts. Deformation of the chassis will cause stress prejudicial to the pump and the drive device and put the coupling out of true, thereby causing vibrations, noise and premature wear. Care must be taken so that the chassis is clear of the ground, apart from the base plates.

The chassis is equipped with a ground connection that must be used.

We recommend leaving an unoccupied space of about 20 cm, on either end of the chassis, to permit access to the bolts fastening the pump, reduction gear and motor together.

2.8 Alignment of motor / pump and reduction gearbox / pump shafts

 WARNING	<p>OPERATION WITHOUT THE SHAFT PROTECTOR CAN CAUSE SERIOUS PERSONAL INJURY, MAJOR PROPERTY DAMAGE OR DEATH.</p>
	
<p>Do not operate without guard in place.</p>	

 WARNING	<p>DISCONNECT THE ELECTRICITY SUPPLY BEFORE ANY MAINTENANCE OPERATION.</p>
	
<p>Dangerous voltage. Can cause injury and death.</p>	

The motor and pump shafts are perfectly aligned in the factory before shipment, but they must be checked and realigned after installation if necessary.

To check the alignment and coupling, use a set square to control the axial misalignment, and feeler gauges for angular misalignment.

For this, see pump unit Instructions.

2. INSTALLATION (continued)

The 3 figures below show the operation clearly.

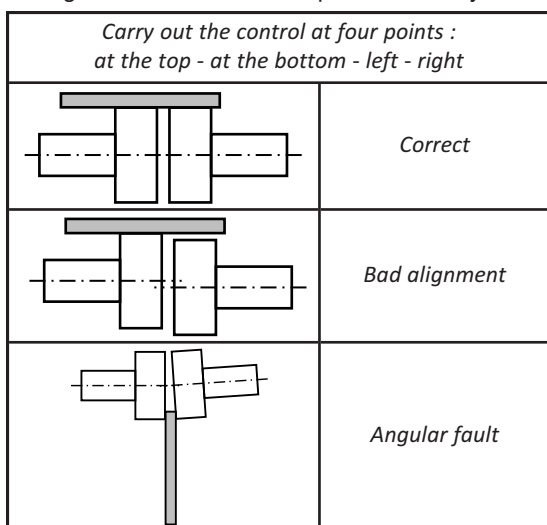

It is important to control the alignment at every step of installation in order to ensure that none of these steps generates stress on the pump unit or the pump itself :

- after fastening on foundations
- after fastening the piping
- after the pump has operated at normal operating temperature.

REMINDER :

Do not rely on the flexible coupling to compensate for misalignment.

2.9 Electric motors

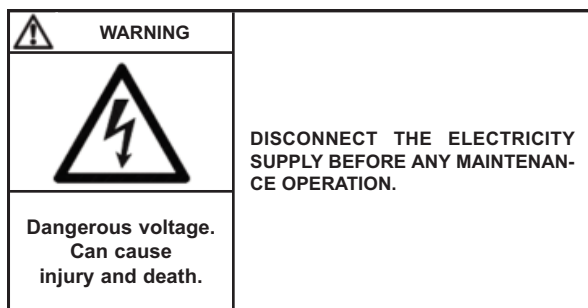

Check that the supply voltage matches the indications on the motor rating plate.

Comply with the wiring diagram, make sure the wires are rated for the power and take care with the contacts which must be thoroughly tightened.

The motors must be protected by appropriate circuit breakers and fuses.

Connect the regulatory ground connections.

Check the direction of rotation :

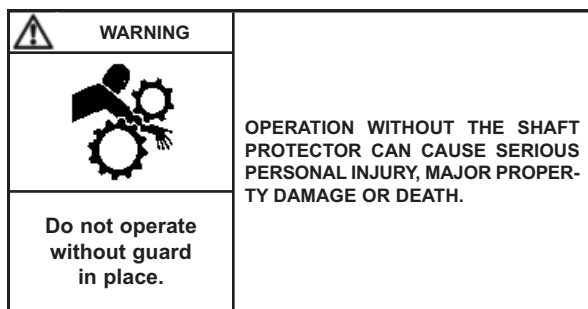

This fundamental checking of the pump must be done without any product, with the inlet and outlet circuit open to the air, for example, to avoid any risk of an unexpected pressure rise. Start the pump empty to check the correct operation of the connections and check that the direction of rotation corresponds to installation's inlet and outlet direction. Follow the instructions below if necessary to change the direction of rotation.

Three phase motor : switch any two wires or two phases of the current supply.

Two phase motor : switch the two wires of the same phase.

Single phase motor : comply with the instructions of the manual supplied with the motor.

2.10 Diesel engine drive

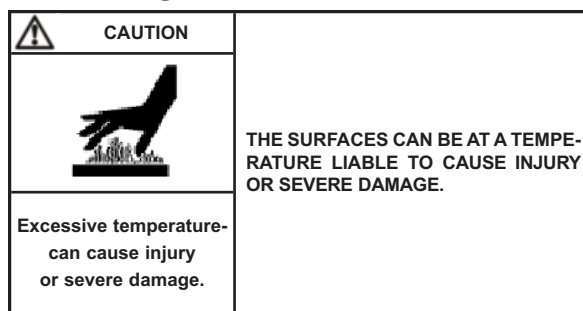

Do not forget that these engines are not reversible. It is therefore vital to carefully check the inlet and outlet sides of the pump before connecting the pump unit to the piping.

The use of diesel engines is now well known. Nevertheless, we strongly recommend that you carefully read the technical manuals concerning them.

2.11 Belt drive transmission

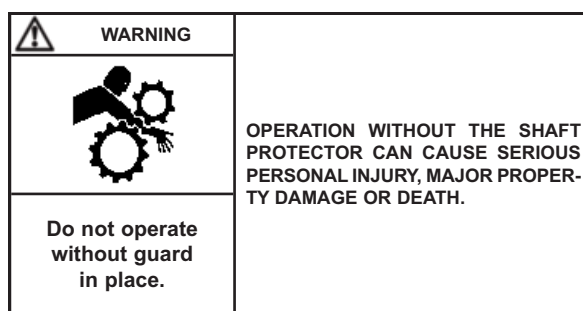

The use of belt drive transmission requires usage of an external bearing support to take the extra load generated due to the belt tension. Standard bearing supports from the market place are suitable to do the job.

The bearing support will be place close to the shaft extremity while saving enough room for the pulley.

The belt tension will be adapted following the common technical practices. Not following the adapted tension can break the pump shaft.



The belt drive system must be cover by a guard following the up to date standards. That guard being there to protect people from injury.

3. USE

3.1 Storage



In the case of prolonged shutdown or storage, we recommend dismantling the pump and greasing it thoroughly. If it cannot be dismantled, it should be filled with oil via its orifices (inlet and outlet) and rotated slowly by hand to allow the oil to penetrate. The flange seal surfaces should be thoroughly greased to protect them against atmospheric oxidation.

3.2 Pumping hot products

	CAUTION
	<p>THE SURFACES OF THE PUMP CAN BE AT A TEMPERATURE LIABLE TO CAUSE INJURY OR SEVERE DAMAGE.</p>
<p>Excessive temperature- can cause injury or severe damage.</p>	

When pumping products at high temperatures, take care when starting the pump for the first time, tighten the bolts to compensate for expansion effects.

3.3 Pump filled with product at shutdown



	WARNING
	<p>FAILURE TO INSTALL ADEQUATELY SIZED PRESSURE RELIEF VALVE(S) CAN CAUSE PROPERTY DAMAGE, PERSONAL INJURY OR DEATH.</p>
<p>Hazardous pressure can cause personal injury or property damage.</p>	



In the case where the pumping circuit is situated between isolating valves and/or has a check valve, you must bear in mind the variations in temperature that can occur, leading in particular to the expansion of the product in the circuit. In this case, provide a means of releasing the expansion volume.

The use of a relief valve can suffice for this function. The opening pressure of this valve must be compatible with the pressure allowed by the parts composing the circuit.

With products including particles that settle at shutdown, it is necessary to ensure that the consistency of the deposited products will not affect the start-up of the pump.

3.4 Starting-up the pump

	WARNING
	<p>FAILURE TO RELIEVE SYSTEM PRESSURE PRIOR TO PERFORMING PUMP SERVICE OR MAINTENANCE CAN CAUSE PERSONAL INJURY OR PROPERTY DAMAGE.</p>
<p>Hazardous pressure can cause personal injury or property damage.</p>	

	WARNING
	<p>OPERATION WITHOUT THE SHAFT PROTECTOR CAN CAUSE SERIOUS PERSONAL INJURY, MAJOR PROPERTY DAMAGE OR DEATH.</p>
<p>Do not operate without guard in place.</p>	

Before starting up the pump, always ensure that the pumping conditions are correct, with the corresponding valves open, especially the inlet valve. For products requiring heating, they must be brought to their pumping temperature before starting the pump.

3.5 Shutting down the pump

When shutting down the pump, we recommend waiting for the pump to stop completely before closing the valves, especially the inlet valve.

3.6 Restarting

Follow the standard start-up procedure for the pump/motor-driven pump, as well as the instructions below.



Turn the pump by hand to make sure the parts move freely.



Replace the grease used to lubricate the bearing.



If the pump has a safety bypass, remove it and inspect the parts and make sure they move freely (see § BYPASS for removal instructions).



4. OPENING THE PUMP TO INSPECT THE CYLINDER/PISTON AND BUSHINGS



Before opening the pump, always ensure that it has been drained and release the pressure it may contain. Make sure the isolation valves, if any, are closed before pulling out the drain plug **812** and its seal **848**.



	WARNING	
		
<p>Dangerous voltage. Can cause injury and death.</p>		<p>DISCONNECT THE ELECTRICITY SUPPLY BEFORE ANY MAINTENANCE OPERATION.</p>

	WARNING	
		
<p>Hazardous pressure can cause personal injury or property damage.</p>		<p>DISCONNECTING THE FLUID OR PRESSURE CONTAINMENT COMPONENTS DURING PUMP OPERATION CAN CAUSE SERIOUS PERSONAL INJURY, DEATH OR MAJOR PROPERTY DAMAGE.</p>

	WARNING	
		
<p>Hazardous pressure can cause personal injury or property damage.</p>		<p>FAILURE TO RELIEVE SYSTEM PRESSURE PRIOR TO PERFORMING PUMP SERVICE OR MAINTENANCE CAN CAUSE PERSONAL INJURY OR PROPERTY DAMAGE.</p>



	WARNING	
		
<p>Hazardous or toxic fluids can cause serious injury.</p>		<p>IF PUMPING HAZARDOUS OR TOXIC FLUIDS, THE SYSTEM MUST BE FLUSHED PRIOR TO PERFORMING ANY SERVICE OPERATION.</p>

	WARNING	
		
<p>The weight of the parts can be dangerous and may provoke bodily injuries or material damages.</p>		<p>BE CAREFUL WITH THE WEIGHT OF THE PARTS WHEN THEY ARE BEING REMOVED.</p>

	CAUTION	
		
<p>Slippery lubricant. Spills should be cleaned up.</p>		<p>THE PUMP LUBRICANT IS VERY SLIPPERY AND MAY CAUSE SERIOUS INJURY. ANY SPILLS MUST BE CLEANED UP.</p>

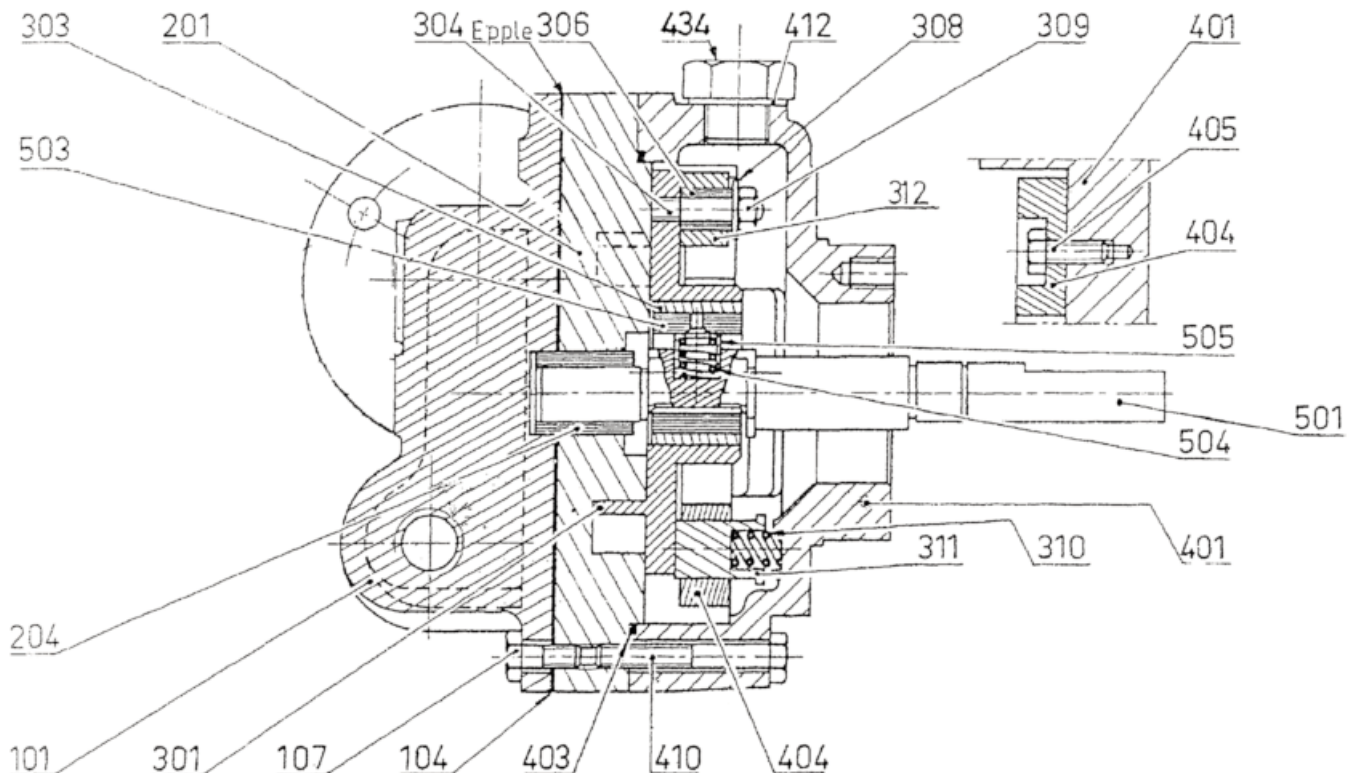
4. OPENING THE PUMP TO INSPECT THE CYLINDER/PISTON AND BUSHINGS (continued)



 WARNING	BE CAREFUL WITH THE WEIGHT OF THE PARTS WHEN THEY ARE BEING REMOVED.
	
<p>The weight of the parts can be dangerous and may provoke bodily injuries or material damages.</p>	

4.1 Necessary tools

- 7 - 8 - 30 open-end spanner
- 19 socket spanner
- adjustable spanner
- 1 plastic mallet
- 1 flat screwdriver
- 1 tube for assembling the bearings

4.2 Disassembly for inspection

4.2.1 To remove front cover

Remove front cover screws **410**.

Remove the front cover **401** by progressively separating it from the pump body and with it the piston **301**, the shaft and the mechanical seal (shaft part).

4.2.2 To remove piston

Remove the piston **301** by pulling it along the shaft **501**.

4.2.3 To remove mechanical seal and shaft

Remove the mechanical seal and the shaft by following the directions § MECHANICAL SEAL.

4.3 Reassembly

Reassembly is done in the reverse order than the dismantling.

Take the following precautions :

- Check the condition of the mechanical seal (see § MECHANICAL SEAL).
- Check the condition of the spring **504** and the piston bearing (mini length in the rest : 13,5 mm). Light load must be applied to the spring in order to insert the piston **301** into the cylinder **201**.
- Check also that the piston backsprings **310** (mini length in the rest : 22,5 mm).
- Before refitting the front cover **401**, do not forget to refit the front cover seal **403** after making sure it is in good condition.

5. MONODIR MECHANICAL SEAL

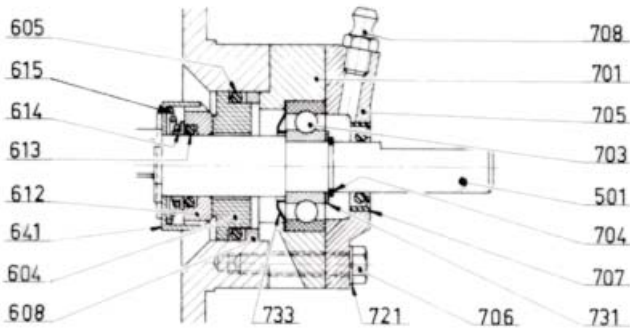

5.1 Operation

The shaft **501** with the driver **641** drive seal housing **612**, spring **615**, spring guide **614** and seal **613**.

Stationary seal face **604** is holden in pump body by seal **605**.

Sealing is done :

- on the shaft, by the seal **613** rotating with it,
- by the surfaces in contact between the rotating seal housing **612** and the static stationary seal face **604**,
- in the bore of the pump body by the seal **605** tightened between the stationary seal face **604** and the washer **608**.

Sealing is therefore done as a function of the stationary seal face condition of these contact surfaces and the seals **605** and **613**.

5.2 Disassembly

	WARNING
	DISCONNECT THE ELECTRICITY SUPPLY BEFORE ANY MAINTENANCE OPERATION.
Dangerous voltage. Can cause injury and death.	

	WARNING
	FAILURE TO RELIEVE SYSTEM PRESSURE PRIOR TO PERFORMING PUMP SERVICE OR MAINTENANCE CAN CAUSE PERSONAL INJURY OR PROPERTY DAMAGE.
Hazardous pressure can cause personal injury or property damage.	

	WARNING
	DISCONNECTING THE FLUID OR PRESSURE CONTAINMENT COMPONENTS DURING PUMP OPERATION CAN CAUSE SERIOUS PERSONAL INJURY, DEATH OR MAJOR PROPERTY DAMAGE.
Hazardous pressure can cause personal injury or property damage.	

	WARNING
	IF PUMPING HAZARDOUS OR TOXIC FLUIDS, THE SYSTEM MUST BE FLUSHED PRIOR TO PERFORMING ANY SERVICE OPERATION.
Hazardous or toxic fluids can cause serious injury.	

Before opening the pump, you must always drain it and release the pressure it may contain. Make sure that the isolation valves, if any, are closed or drain the installation before pulling out the drain plug **812** and its seal **848**.

After opening the pump :

- remove screws **706** and washers **721**.
- remove the cover **705** with its seal **707**.
- release shaft by tapping with a mallet on opposite shaft end.
- remove the ring **704** and the washer **731**. Then, by tapping on shaft end, drive side, the set : bearing cage **701**, bearing **703** and protection circlip **733**.
- remove the washer **608**, the seal **605**, the stationary seal face **604** and the set : seal housing **612**, seal **613**, guide **614**, spring **615** and driver **641**.

5.3 Reassembly

Check the good condition of the seals **707**, **605** and **613**.

Check the surfaces in contact of the stationary seal face **604** and the seal housing **612** are flat and mirror smooth.



Replace all parts on shaft in the reverse order and install ring **704**.



Replace shaft with ball bearing and mechanical seal on the pump, making sure one of the drain vents is turned downwards.

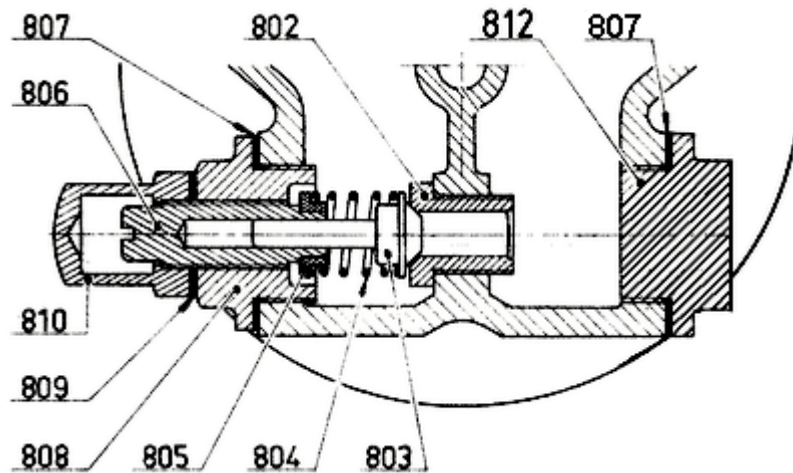

Install the cover **705** and its seal **707** (taking care not to damage the lip of this seal with the groove of the shaft keying) and the screws **706** with their washer **721**.



6. BYPASS



 CAUTION	
	<p>THE PUMP LUBRICANT IS VERY SLIPPERY AND MAY CAUSE SERIOUS INJURY. ANY SPILLS MUST BE CLEANED UP.</p>
<p>Slippery lubricant. Spills should be cleaned up.</p>	

 WARNING	
	<p>IF PUMPING HAZARDOUS OR TOXIC FLUIDS, THE SYSTEM MUST BE FLUSHED PRIOR TO PERFORMING ANY SERVICE OPERATION.</p>
<p>Hazardous or toxic fluids can cause serious injury.</p>	

 WARNING	
	<p>FAILURE TO RELIEVE SYSTEM PRESSURE PRIOR TO PERFORMING PUMP SERVICE OR MAINTENANCE CAN CAUSE PERSONAL INJURY OR PROPERTY DAMAGE.</p>
<p>Hazardous pressure can cause personal injury or property damage.</p>	

 WARNING	
	<p>INCORRECT SETTINGS OF THE PRESSURE RELIEF VALVE CAN CAUSE PUMP COMPONENT FAILURE, PERSONAL INJURY AND PROPERTY DAMAGE.</p>
<p>Hazardous pressure can cause personal injury or property damage.</p>	

6.1 Operation

The bypass operates like a safety valve, by automatically limiting the discharge pressure at the value for which it is adjusted.

When the discharge pressure reaches the adjusted pressure of the spring, the valve **803** opens, thus permitting the partial or total return of the liquid to the inlet side of the pump.

It should be noted that the role of the bypass, as a safety device, is limited to protecting the pump against accidental over-pressure. For all electric motors, unless the model used can handle the increased load due to maximum overpressure, it is vital to provide appropriate over-load protection.

6.2 Orientation

The bypass only protects the pump in one direction of operation. Consequently it is necessary to check that the pumps direction of operation is correct by verifying that the cap **810** is located on the inlet side. The bypass must be reversed if in the wrong direction.

6. BYPASS (continued)

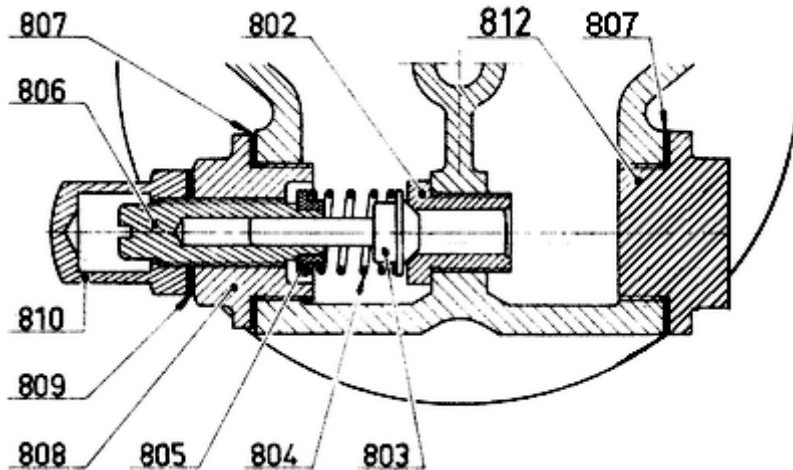

Loading (bar)	
Mini	Maxi
1,65	5

6.3 Inversion

	WARNING
	BE CAREFUL WITH THE WEIGHT OF THE PARTS WHEN THEY ARE BEING REMOVED.
The weight of the parts can be dangerous and may provoke bodily injuries or material damages.	

	WARNING
	FAILURE TO RELIEVE SYSTEM PRESSURE PRIOR TO PERFORMING PUMP SERVICE OR MAINTENANCE CAN CAUSE PERSONAL INJURY OR PROPERTY DAMAGE.
Hazardous pressure can cause personal injury or property damage.	

	WARNING
	IF PUMPING HAZARDOUS OR TOXIC FLUIDS, THE SYSTEM MUST BE FLUSHED PRIOR TO PERFORMING ANY SERVICE OPERATION.
Hazardous or toxic fluids can cause serious injury.	

	WARNING
	DISCONNECT THE ELECTRICITY SUPPLY BEFORE ANY MAINTENANCE OPERATION.
Dangerous voltage. Can cause injury and death.	

Before commencing work, make sure that the pump cannot be started up, even accidentally. Before opening the pump, it must be drained and relieved of any pressure it may contain. Take care to check that the isolation valves, if any, are closed before pulling out the drain plug **812** and its seal **848**.

To reverse the bypass, remove the nut **808** and the set of parts **805 - 806 - 807 - 809** and **810**. Remove the valve **803**, its spring **804** and fit those parts on the opposite side.

Fit the plug **812** and the seal **848** in the place of the nut **808**.

6.4 Adjustment

	WARNING
	PUMPS OPERATING AGAINST A CLOSED VALVE CAN CAUSE SYSTEM FAILURE, PERSONAL INJURY AND PROPERTY DAMAGE.
Hazardous pressure can cause personal injury or property damage.	

To adjust the bypass, unscrew the cap **810** and its seal **809**, turn the adjustment screw **806** clockwise to increase the discharge pressure, and anticlockwise to decrease it. Once the adjustment is finished, do not forget to re-screw the cap **810** and its seal **809**.



Adjustment of the bypass is satisfactory when the flow meets the pumps requirements and when the motor bears the power increase due to the overpressure seen upon closing the discharge. This is how the bypasses of our pump units are adjusted, as a function of the information provided by our Technical Services.

The pumps supplied bare shaft are delivered with a standard bypass setting which needs to be adjusted with the exact working conditions and installation, as per the above described procedure.

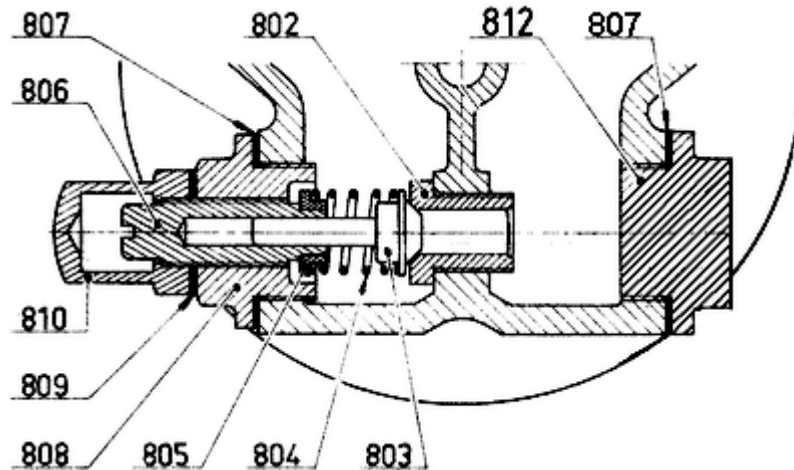
6. BYPASS (continued)



6.5 Obtaining the flow

 WARNING	<p>PUMPS OPERATING AGAINST A CLOSED VALVE CAN CAUSE SYSTEM FAILURE, PERSONAL INJURY AND PROPERTY DAMAGE.</p>
 <p>Hazardous pressure can cause personal injury or property damage.</p>	

Before carrying out any adjustments, make sure that there is a means of reading the pressure during adjustment and that the components of the circuit are rated for the adjustment pressure. The pressure must at no time exceed the pressure rating of the lowest rated component.

If the flow is lower than anticipated, the cause may be due to incorrect adjustment of the bypass valve.

To correct the flow, gradually tighten the adjustment screw **806** after making sure that the pump is running well at the recommended speed.

If during adjustment, you compress the spring to its limit or disturb the operation of the motor, without obtaining the flow required, this means that the pump unit must operate with a pressure higher than that for which it was designed. In this case you should consult our Technical Services.

When you obtain the required flow, make sure that the motor can withstand the increased power due to the overpressure created by closing off the discharge line.

6.6 Energy consumption

If the energy consumption does not correspond with expectations, the reason may be poor adjustment of the bypass valve.

If consumption is low and you do not get the required flow, close the discharge valve and tighten the adjustment nut until the correct power consumption level is reached. Then open the discharge valve as it was before adjustment.

If consumption is high, close the discharge piping and slacken the adjustment nut until the correct power consumption level is reached. Then open the discharge valve as it was before adjustment.

6.7 Bypass use

Standard bypass should not be operated too frequently (even less permanently) since it would result in useless power consumption and material fatigue detrimental to equipment life.

7. MAINTENANCE

7.1 Greasing

Except for special cases, the MOUVEX pump only requires lubrication of the shaft inlet bearing.

Use a grease for good quality ball bearings.

Lubrication must be done every 1,000 hours of operation or at least once a year.

The quantity of grease to be added must not exceed 5 cm³.

For pumps operating at high temperatures (in principle from 100°C upwards) use a grease with a high drop point.

If the pump is equipped with a Stofer oiler, and when the type of product requires it, the pump must be greased before each start-up, after each shutdown and every 3 to 4 hours of continuous operation.

Preference should be given to lubricants insoluble in the product pumped and, in the case of hot products, lubricants that maintain good viscosity at the operating temperature.

The other elements of the pump unit (motor, reduction gear) should be maintained in conformity with their specific technical instructions.

7.2 Checking of parts

The piston **301** and the cylinder **201** are active parts (wearing parts). These parts must be replaced if the thickness measurements are lower than the following values :

- Piston (**301**) 5 mm
- Cylinder (**201**) 17 mm

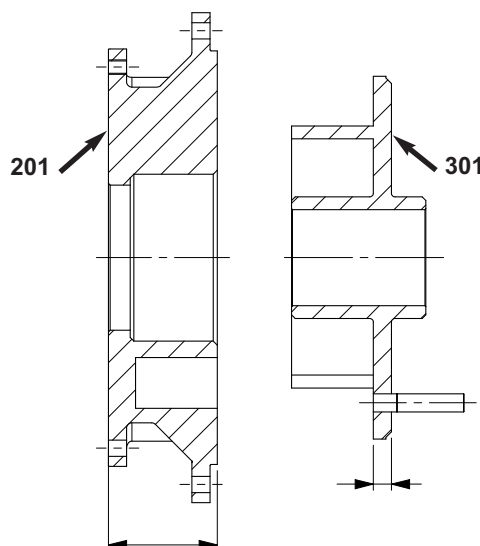

8. DRILLED PISTON PUMP

Drilling the piston permits the circulation of the product behind the piston and therefore avoids any "dead" zone.

It also helps to avoid any over-pressure problems related to the expansion of hot products.

The piston is drilled with 2 holes (A) though only one remains open, **always on the inlet side** (the other is closed in the factory).

If the rotation direction of the pump requires the standard assembly to be changed, open the plugged hole by removing the screw and use the screw to close the other hole on the discharge side, with removable thread locker (typ Loctite® 243*).

The screw must be recessed from cylinder rubbing surface (1 mm).

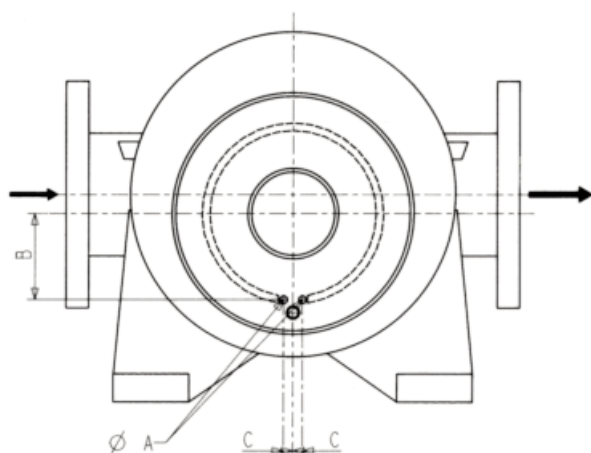



Dimension and position of holes		
Ø A	C ± 0.2	B ± 0.2
M4	2,3	25,5

* Loctite® is a registered trademark.

9. STORAGE

9.1 Short duration (≤ 1 month)

 WARNING	
	
Toxic or hazardous fluids can cause serious injury.	
IF PUMPING HAZARDOUS OR TOXIC FLUIDS, THE SYSTEM MUST BE FLUSHED PRIOR TO PERFORMING ANY SERVICE OPERATION.	

MOUVEX pumps and motor-driven pumps are well lubricated when delivered to protect the internal parts during brief storage in a building where :

- the temperature remains between 10°C and 50°C.
- the relative humidity does not exceed 60%.
- exposure to vibration is limited.
- pump is stored in an area sheltered from bad weather and sun.

9.2 Long duration (> 1 month)

The recommendations from the manufacturer should be followed if the pump is stored with its gear motor.

Pump ports should be filled with a non-corrosive liquid that is compatible with the pump components in order to prevent corrosion.

Unpainted external surfaces of the pump (e.g. shafts, couplings, etc.) should be covered in some form of anti-corrosion protection.

The bearing should be well greased. If the pump is to be stored for more than the life of the grease, this one should be replaced in time to prevent an excessive degradation of its qualities.

The best storage conditions are inside a building that meets the conditions set out above.

If inside storage is not possible, the materials should be covered to prevent direct exposure to sun and bad weather. This protection should also prevent condensation.

Rotate pump shaft manually a few revolutions every two months.

10. SCRAPPING

The pump must be scrapped in compliance with the regulations in force.

During this operation, particular care must be paid to the drainage stages of the pump (pumped product).

11. TROUBLESHOOTING

ZERO OR INSUFFICIENT FLOW			
1			PRELIMINARY CHECKS
	1-1		Make sure that the plastic plugs have been taken away from the ports of the pump and that the pump is running (defective drive, damaged motor, etc., faulty transmission : broken coupling, sliding belt, worn or poorly coupled clutch, etc.).
	1-2		Make sure that the pump rotates in the correct direction corresponding to the direction in which the liquid circulates in the installation (cf. the pump plate). If necessary, change the electric motor connections or adjust the piping as necessary (diesel engine drive).
	1-3		Make sure that there is liquid in the tank from which the pump draws and that the end of the inlet piping is constantly submerged.
	1-4		Make sure that the pump rotation speed is sufficient. Determine this by checking the speed of the pump motor (see motor plate) and the speed reduction ratio (see reduction gearbox plate) or use a rev. counter. Check the correct tension of belts.
			If these checks do not highlight the problem :
2			MEASURE THE DISCHARGE PRESSURE (as close to the outlet of the pump as possible, with a minimum distance of 5 pipe diameters).
	2-1		If the pressure is lower than the figures given for the material, or null, this could be due to :
		2-1-1	A poorly adjusted bypass, the valve setting is lower than the discharge pressure (tighten the set screw or replace the spring after checking that the electric motor is suitably protected).
		2-1-2	The bypass valve is not closed ; either the plunger has not returned to its initial position, or there is dirt on the valve seat.
		2-1-3	The pump is worn, this will also affect the suction capacity of the pump (cf 3-2-2 c).
	2-2		If the pressure complies with the equipment data (pump speed and motor output) it is possible that :
		2-2-1	The pressure required for the given installation to obtain the required flow rate is too high and the flow is partially or totally circulating via the bypass, or : a. the height of the discharge is too great (reduce it by bringing the discharge tank to the level where the pump is). If suction conditions are favourable, the pump can also be moved closer to the discharge tank. b. that head losses are too high because : - the piping is unsuitable (too many "bends", too long or the diameter is too narrow) for the process conditions : Flowrate, Specific Gravity, Viscosity (this can change considerably with temperature). Reduce the head losses by simplifying the circuit : reduce of the number of fittings, valves, elbows, etc... Move the pump closer to the discharge tank or vice versa, if conditions permit. Increase the diameter of the piping, etc... Reduce the product viscosity via heating. Reduce the flow, etc... - of partially blocked piping (valve partially closed, tap partially shut, cloth obscuring flow, etc.).
		2-2-2	The discharge piping is completely blocked (valve fully closed, tap completely closed, cloth plugging flow, full protection seal left by carelessness, etc...), in this case, all the liquid passes via the bypass.

11. TROUBLESHOOTING (continued)

3			MEASURING THE VACUUM PRESSURE (as close as possible to the pump inlet, inlet side).
	3-1		If the vacuum is high, e.g. higher than or equal to 6 to 7 metres WC (0.6 to 0.7 bara i.e. about 45 or 50 cm of mercury), this can result in pump noise. The cause could be :
		3-1-1	<ul style="list-style-type: none"> a. the suction lift is too high (reduce it by taking the pump down closer to the level of the liquid) b. the dynamic suction losses are too high : <ul style="list-style-type: none"> 1. cf 2-2-1 b 2. the inlet piping orifice is too close to the bottom of the tank.
		3-1-2	The inlet piping is completely blocked (valve, tap, filter, cloth, full seal forgotten, etc.)
		3-1-3	The liquid vapour pressure is too high (or has become too high following, for example, a change of temperature). Bring the pump closer to the level of the liquid, install the pump closer to the feed or cool the liquid to reduce the vapour pressure.
	3-2		If the vacuum is low, for example, less than 3 metres WC (i.e. about 20 cm of mercury), check for leaks on the inlet pipe, isolate the pump from the inlet piping (by closing the valve nearest the pump or by inserting a full flange seal) and measuring the vacuum once again.
		3-2-1	<p>If the vacuum is high with the isolating valve closed on suction line, e.g. higher than or equal to 6 or 7 metres WC (i.e. about 45 to 50 cm of mercury), the pump is not the cause :</p> <ul style="list-style-type: none"> a. there must be an air inlet upstream of the pump isolating valve. b. the liquid vapour pressure is or has become too elevated due to a change of temperature (cf 3-1-3).
		3-2-2	<p>If the vacuum is low or non-existent, the reason could be :</p> <ul style="list-style-type: none"> a. that the bypass valve is not closing properly, due to dirt on the valve seat. b. air is entering the pump (check the front cover seals, flanges, etc...) c. the pump is worn and the internal tightness is out of specification (the piston bushings are worn, worn piston and cylinder, broken piston wear compensation springs, worn partition, broken shaft).
ABNORMAL HEATING OF BEARINGS			
4			This heating can be caused by :
	4-1		- excessive tension in the transmission (belt or chain) on the pump shaft (check the alignment of pulleys and the correct tension of belts).
	4-2		- excessive pulling on the pump flanges by the piping (in this case, it must have been necessary to force the piping into position to connect it to the pump).
	4-3		- poor alignment of the pump - due for example to 4-2 (the pump is partially or totally uncoupled, the pump shaft and drive shaft are not aligned with each other).
	4-4		- inadequate anchoring of the pump unit leading to deformation of the chassis (make sure that the chassis is clear of the ground except for the 3 anchoring points).
	4-5		- seizing of the bushings (cured product preventing lubrication and cooling, excess power, etc...).
LEAKING SEALS			
5			<p>The seal may leak if :</p> <ul style="list-style-type: none"> a. it was damaged during assembly (scratching on the shaft), damage to 'O' rings in seal, b. it is incompatible with the product (chemical and mechanical aggression / abrasion of 'o' rings and seal faces), c. it is worn through normal use.
6			The shaft is worn at the seal or does not rotate correctly due to poor alignment, excessive tension on the transmission belts, chains, etc...

11. TROUBLESHOOTING (continued)

ABNORMAL NOISES			
			These noises can be caused by hydraulic and mechanical sources. They can be distinguished by the fact that only the former disappear (or at least lessen) when air is allowed into the inlet pipe.
7			HYDRAULIC NOISES
			These noises can come from insufficient product being supplied to the pump, or :
	7-1		- the rotation speed is too high for the installation conditions (increase of viscosity due to a change of product or a reduction of temperature, etc.).
	7-2		- that the suction head is too high or has become too high due to excessive head losses following clogging of the piping or filter, a change of viscosity of the liquid, etc.,
	7-3		- an increase of the vapour pressure with a rise of temperature.
8			MECHANICAL NOISES
			These can stem from :
	8-1		- the bypass valve knocking on the seat when the discharge pressure is close to the bypass adjustment pressure (turn the adjustment screw after making sure that the electric motor is suitably protected).
	8-2		- abnormal stress on the pump : the transmission is pulling on the shaft, pulling on the flanges by the piping.
	8-3		- a broken part or foreign body has entered the pump.
EXCESS POWER CONSUMPTION			
9			The most spectacular event occurs when a diesel engine stalls or the power to an electric motor is shut off.
	9-1		If this incident occurs when closing the discharge line, the cause may be : a. the bypass is assembled back to front. b. the bypass is adjusted too tight. c. the motor protection is adjusted too low or wrong circuit breaker have been fitted.
	9-2		If the incident occurs during operation, the cause could be : a. an inadequate motor (in this case, the discharge pressure complies with what was expected). b. head losses higher than expected - following higher viscosity or specific gravity than planned initially (in this case, the discharge pressure is higher than that planned. The pressure can be reduced by loosening the bypass adjustment screw - the flow is decreased). c. excessive speed of rotation. d. a fault of the equipment (faulty alignment, deformation of the chassis, stress exerted by the piping on the flanges, seizing, etc.).
			Excessive consumption of electricity can also be due to a poor motor connection (e.g. a 3 phase motor operating on 2 phases).