



**INSTRUCTIONS 1401-Q00 e**

Section	1401
Effective	October 2022
Replaces	April 2020

Original instructions

**DDK**  
**SCREW COMPRESSORS**  
**MISTRAL - B600 - TYPHON II**

***Bare shaft end for truck installation***

**INSTALLATION**  
**MAINTENANCE**  
**SAFETY**  
**STORAGE**



**This Instructions only contains bare shaft end compressors general information.**  
**It is imperative to have in complement the compressor one and also all the others relatives to the accessories, also the parts list before installing the equipment.**

**EC CERTIFICATE OF CONFORMITY :**

The EC Certificate of Conformity (paper version) is systematically attached to the equipment when shipped.

**WARRANTY :**

MISTRAL - B600 - TYPHON II screw compressors are covered 24 months by warranty within the limits mentioned in our General Sales Conditions. The use of the BSC3 oil carries our warranty from 24 to 36 months. In case of a use other than that mentioned in the Instructions manual, and without preliminary agreement of MOUVEX, warranty will be canceled.

Warranty extension with oil BSC3 : See § WARRANTY.



Z.I. La Plaine des Isles - F 89000 AUXERRE - FRANCE  
Tel. : +33 (0)3.86.49.86.30 - Fax : +33 (0)3.86.49.87.17  
contact.mouvex@psgdover.com - www.mouvex.com

Your distributor :

# MOUVEX TRUCK SCREW COMPRESSORS

## SAFETY, STORAGE, INSTALLATION AND MAINTENANCE INSTRUCTIONS

### MODELS : DDK

### MISTRAL - B600 - TYPHON II

### Bare shaft end for truck installation

#### Definition of safety symbols



This is a SAFETY ALERT SYMBOL.

When you see this symbol on the product, or in the manual, look for one of the following signal words and be alert to the potential for personal injury, death or major property damage.



Warns of hazards that **WILL** cause serious personal injury, death or major property damage.



Warns of hazards that **CAN** cause serious personal injury, death or major property damage.



Warns of hazards that **CAN** cause personal injury or property damage.

#### NOTICE

Indicates special instructions which are very important and must be followed.

TABLE OF CONTENTS	Page
<b>1. SAFETY DATA</b> .....	<b>3</b>
<b>2. INSTALLATION</b> .....	<b>4</b>
2.1 Mounting location .....	4
2.2 At suction .....	5
2.3 Discharge .....	5
2.4 Drive .....	6
<b>3. MAINTENANCE</b> .....	<b>7</b>
3.1 Compressor maintenance .....	7
3.2 Air filter replacement procedure .....	7
3.3 Drive train inspection .....	7
3.4 Check valve and relief valve inspection .....	7
<b>4. WARRANTY</b> .....	<b>7</b>
4.1 Warranty claims .....	7
4.2 24-months warranty extension with BSC3 oil .....	7
<b>5. TROUBLESHOOTING</b> .....	<b>8</b>
<b>6. STORAGE CONDITIONS</b> .....	<b>8</b>
6.1 Compressor .....	8
6.2 BSC oil .....	8
<b>7. SCRAPPING</b> .....	<b>8</b>
<b>8. COMPRESSORS FORM INFORMATION</b> .....	<b>9</b>

#### REMARKS :













MOUVEX truck screw-type compressors **MUST** be installed in systems designed by qualified personnel. The installation **MUST** be in compliance with local standards, national regulations and rules of safety.

**This manual is designed to permit installation and commissioning of MOUVEX truck screw-type compressors and MUST accompany the compressor.**

**Maintenance of MOUVEX screw-type compressors must ONLY be carried out by qualified technicians. This maintenance must meet local and national standards as well as all safety regulations. Read this manual, including all instructions and warnings, in full BEFORE any use of MOUVEX compressors.**

**Do not remove the warning and use label stickers that are found on the compressors.**

# 1. SAFETY DATA

 <p><b>WARNING</b></p>	
	<p>IT IS IMPERATIVE TO APPLY THE TRUCK PARKING BRAKE AND TO BLOCK THE WHEELS BEFORE ANY INTERVENTION DUE TO RISKS OF SERIOUS BODILY INJURIES OR PROPERTY DAMAGE.</p>
<p>Hazardous machinery can cause severe personal injury or property damage.</p>	
 <p><b>WARNING</b></p>	
	<p>COMPRESSING GASES INTO A VESSEL CONTAINING FLAMMABLE OR EXPLOSIVE GASES OR COMPRESSING FLAMMABLE OR EXPLOSIVE GASES, CAN CAUSE PROPERTY DAMAGE, PERSONAL INJURY OR DEATH.</p>
<p>Hazardous fluids can cause fire, serious personal injury or property damage.</p>	
 <p><b>WARNING</b></p>	
	<p>FAILURE TO INSTALL ADEQUATELY SIZED PRESSURE RELIEF VALVE(S) CAN CAUSE PROPERTY DAMAGE, PERSONAL INJURY OR DEATH.</p>
<p>Hazardous pressure can cause personal injury or property damage.</p>	
 <p><b>CAUTION</b></p>	
	<p>COMPRESSOR, PIPING AND ACCESSORIES WILL BECOME HOT DURING OPERATION AND CAN CAUSE SERIOUS PERSONAL INJURY.</p>
<p>Extreme heat can cause injury or property damage.</p>	
 <p><b>WARNING</b></p>	
	<p>CONTENTS OF THE COMPRESSOR, TANK, PIPING, AND FILTERS COULD BE HAZARDOUS TO HEALTH. TAKE ALL NECESSARY PRECAUTIONS WHEN PERFORMING COMPRESSOR SERVICE OR MAINTENANCE.</p>
<p>Hazardous or toxic fluids can cause serious injury.</p>	
 <p><b>WARNING</b></p>	
	<p>THE NOISE EMITTED BY WORKING MOVEX SCREW COMPRESSOR CAN BE HIGHER THAN 80 DBA. THE END USERS MUST USE, WHEN NECESSARY THE APPROPRIATE EAR PROTECTIONS. FAILURE TO WEAR HEAR PROTECTIONS IN AREAS WHERE THE NOISE IS HIGHER THAN 80 DBA CAN LEAD TO PERMANENT BODY DAMAGE.</p>
<p>A loud noise can cause permanent body damage.</p>	

## SAFETY CHECK LIST

### 1. SAFETY CHECK LIST

1. Before operating the compressor, ensure the vessel to which the compressor is connected is certified to withstand the pressure and /or vacuum produced.
2. Verify adequately sized relief valves have been fitted to protect the vessel. Do not use solvents or inflammable products for cleaning the pipelines and the accessories.
3. Gas/air mixtures which are potentially volatile/explosive must not be introduced or allowed to be introduced into the compressor.
4. All pressure vessel and piping connected to the compressor must be isolated and in a safe operating condition.
5. Operators should wear ear protection when operating truck mounted compressors.
6. There are components within the compressor of sufficient weight to cause injury if mishandled. Use proper lifting devices as necessary.
7. Where necessary, this equipment should be grounded to control static electricity.
8. The temperature of the air leaving the compressor is elevated above ambient due to air compression. Check that the elevated temperatures do not adversely affect the product and any material used in design of the system. Attach clearly marked warning signs to warn of potentially hot surfaces on the compressor, piping and accessories which will burn if touched.
9. Mounting of the compressor must be correctly engineered and the compressor must be properly secured. Refer to the Compressor Mounting section of this manual.

### NOTICE :

MOVEX COMPRESSORS ARE DESIGNED TO PRODUCE COMPRESSED AIR. NOT TO PUMP GASES, LIQUIDS, POWDERS OR CONDENSATES THROUGH THE COMPRESSOR. TO DO SO WOULD VOID THE WARRANTY.

### LIFTING POINTS :

The compressor can be picked up from underneath to be transported.



Discharge flanges threads can be used to install a lifting lug in order to transport the compressor.



## 2. INSTALLATION

The screws used to :

- hold the compressor in place
- mount the inlet flange
- mount the discharge flange

must be at least quality 8-8.

During the assembly, check that no foreign body penetrates into the compressor. The piping inlet and outlet must be perfectly clean.

Any foreign body risks to damage seriously the compressor.

All the fixation points availables must be used except for the TYPHON II where 4 screws must be used. The distance between each screws pair must be greater than 220 mm.



**The presence of foreign bodies in the compressor inlet channel is susceptible of leading to serious property damage or serious injuries.**

### 2.1 Mounting location

The compressor must be installed in a location where it is easily accessible. In particular, check that the oil filling plug , the magnetic plugs and the filter are accessible.

Choose a location where the compressor is relatively protected from gravel projections and road spray as well as exhaust fumes and engine heat. When the compressor is directly driven by universal joints, it will be installed between the chassis side members. In other cases, it can be installed either between the side members or beside the chassis side. The compressor may be installed with a small angle, but please ensure not to exceed the angular values set out in the diagrams below.

If the compressor is to be painted, use high temperature resistant paint.

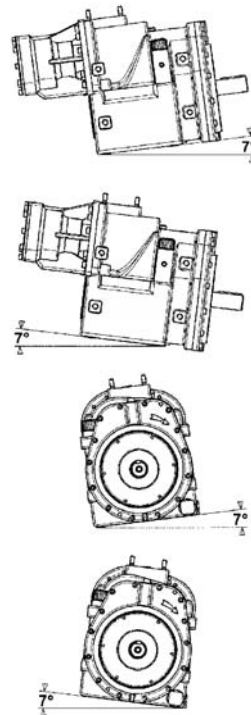

	<b>IMPORTANT</b>
<p>During operation, the temperature of the surface of a compressor and nearby parts can be in the region of 200°C.</p> <p>The compressor and the parts located nearby are thus susceptible of provoking serious burns and property damage.</p> <p>Be careful to not approach elements that are sensitive to heat and affix plates informing users that the compressor is hot, to prevent any risk of burns.</p>	

## 2. INSTALLATION (continued)

### 2.2 At suction

The table below gives the air filter sizes authorised for each compressor.

Compressor	Filter authorised
B600	FC7 or FC10
MISTRAL	FC7 or FC10
TYPHON II	FC10

The suction side of the compressor must be fitted with a MOVEX FC air filter.

This filter must be installed horizontally, rain protection cap upwards.

It must be positioned to avoid gravel projections and road spray as well as exhaust fumes and engine heat.

The air filter is connected to the compressor by a hose. Before making this connection, which must be perfectly sealed, make sure that the inlet pipe and attachment flanges are clean.

The clogging indicator must remain visible to the operator.

The filter must be easily accessible. Leave enough room (about 400 mm) to replace the cartridge, as shown on the drawing below :

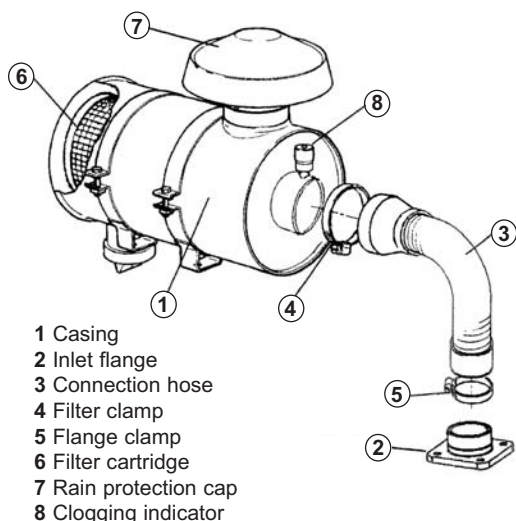
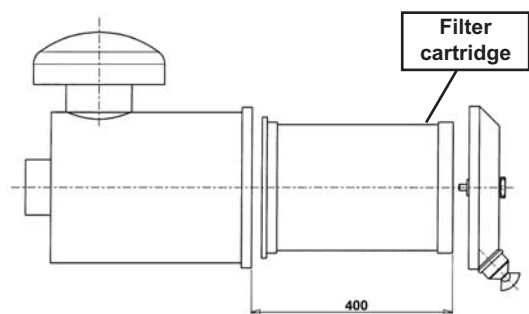

### 2.3 Discharge

#### 2.3.1 Silencer

Dampens noise in pipes. It shall be positioned as close as possible to the compressor discharge.

It must be directly welded to the discharge pipe.

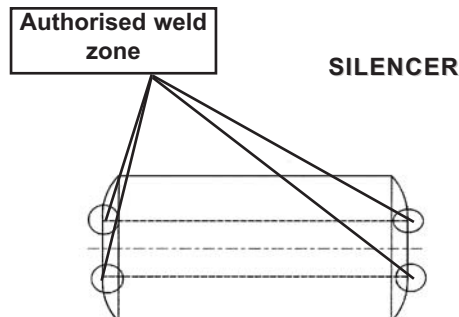

Any weld performed outside of this zone of authorized welding will seriously damage the silencer. In particular, it is not authorized to weld a fixation foot on the silencer.

#### 2.3.2 Check valve and relief valve

The compressor must be protected by a check valve and a relief valve.

See Instructions 1401-E00 MISTRAL B600 TYPHON II CHECK AND RELIEF VALVE.

## 2. INSTALLATION (continued)

### 2.4 Drive

#### 2.4.1 PTO shaft drive

It is mandatory to comply with the following instructions :

- The shaft must be dynamically balanced.
- Its length and its angle must be as small as possible, see table.
- The drive shaft slides perfectly well during rotation.
- The jaws of the universal joints are parallel.
- Coupling flanges show no eccentricity nor warping of the bearing surface.
- The angle formed by the universal joint and the drive shaft must not exceed 15°.
- The compressor shaft must be parallel to that of the drive shaft.

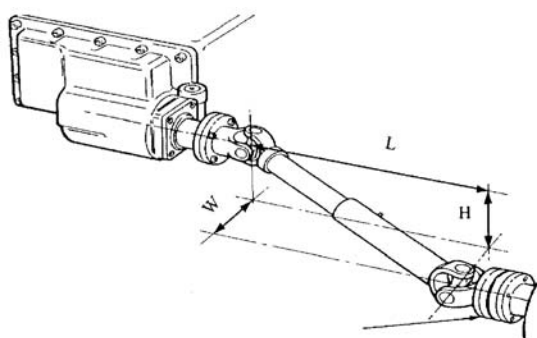

A	Universal joint angle	
0,017	1°	VERY GOOD
0,035	2°	
0,052	3°	
0,070	4°	
0,087	5°	GOOD
0,105	6°	
0,125	7°	
0,141	8°	
0,158	9°	LIMIT VALUES
0,176	10°	
0,194	11°	
0,213	12°	
0,231	13°	
0,249	14°	
0,268	15°	

$$A = \frac{\sqrt{H^2 + W^2}}{L}$$

If H = Zero, A = W / L

If W = Zero, A = H / L

To protect the P.T.O in the event of compressor stalling, it is **necessary to install a torque limiter**. The MOUVEX company shall not be held responsible for damage resulting from such stalling if this stalling is caused by wrong manipulation with the compressor or if a wrong torque limiter is installed.

See Instructions 1401-B00 TORQUE LIMITER - MISTRAL B600 TYPHON II MX12.

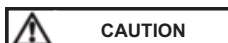

**If the greasing instructions for the universal joint are not respected, this can lead to ruptures of this universal joint, as well as property damage and serious injuries**

#### 2.4.2 Belt / pulley arrangements

**The pulley ratio is determined according to the P.T.O speed and the compressor speed.**

To determine the types of belts and pulleys, refer to the manufacturer 's recommendations.

You must observe the following installation rules :

- The shaft supporting the driving pulley must be perfectly parallel with the compressor shaft.
- Pulleys must be correctly aligned.
- Belts shall be sufficiently tensioned to avoid any slack or slide.
- The belts must be able to pass the power consumed by the compressor.

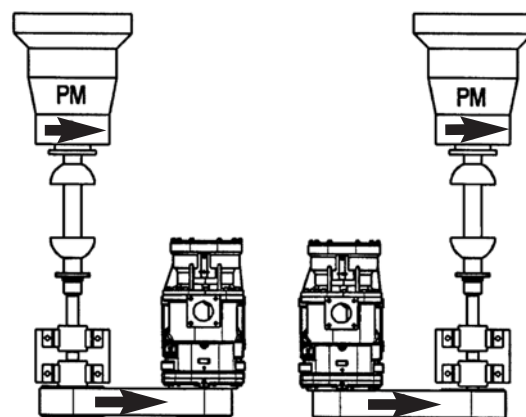

CLOCKWISE P.T.O

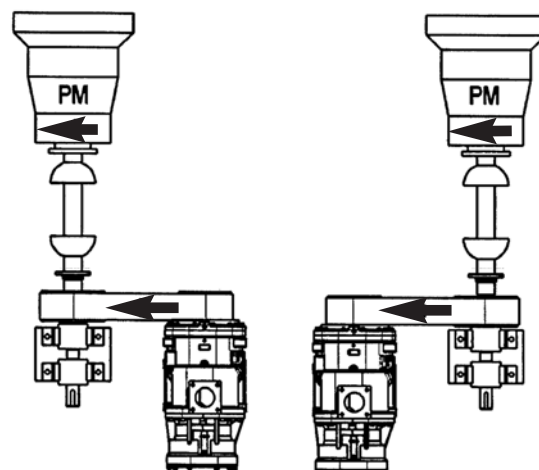

COUNTERCLOCKWISE P.T.O

In all cases, the drive must make it possible :

- To maintain the compressor rotation speed during load variations (pressure variations).
- Not to subject the compressor to sudden or insufficient starts/stops.



---

## 3. MAINTENANCE

### 3.1 Compressor maintenance

See the central instruction for the maintenance programme.

### 3.2 Air filter replacement procedure

Check weekly the clogging indicator. When it turns red, replace the filter cartridge.

Before installing a new cartridge, clean the internal part of the filter housing with a clean damp cloth.



The presence of foreign bodies in the compressor inlet channel is susceptible of leading to serious property damage or serious injuries.

### 3.3 Drive train inspection

#### 3.3.1 PTO Drive

Check monthly that there is no clearance in the jaws and PTO cross pieces by turning the universal joint manually in one direction then in the other direction. Lubricate the universal seal as per manufacturer's recommendations.

#### 3.3.2 Belt & pulley drive

Check monthly that belt tension is sufficient. Retension belts as required

Lubricate the pulley support shaft bearings as per manufacturer's recommendations.

### 3.4 Check valve and relief valve inspection

See Instructions 1401-E00 MISTRAL B600 TYPHON II CHECK AND RELIEF VALVE.

---

## 4. WARRANTY

### 4.1 Warranty claims

The following part are considered as wear part :

- Inlet filter cartridge
- Compressor oil

No failure connected with wear part damage will be accepted under warranty conditions.

The following situations will void warranty for all components of the package :

- Tampering with the setting of the relief valve.
- Presence of foreign body inside the compressor body.
- Traces of damage representative of abnormal use of the package.
- Use of non genuine parts.
- If the compressor is repaired by a repairer who is not a MOUVEX-approved repairer.
- Construction of the package not validated by our Design Office.
- Use of an oil other than BSC for a 13R/15L or 19R/22L compressor and for 20R/30R in their 3<sup>rd</sup> year (provide invoices).

Before returning your equipment to the factory, you must first obtain an Equipment return approval (RMA) from our After Sales Department.

A Compressors form information shall be filled by the installer or distributor and send to MOUVEX in order to claim for a warranty.

### 4.2 24-months warranty extension with BSC3 oil

The 24-months warranty extension with BSC3 oil option increases the warranty for the screw compressor to 60 months :

- Europe zone only,
- Only concerns the bare shaft compressor with or without multiplier, excluding packages and accessories (air filter, torque limiter, check relief valve...),
- Use of BSC3 oil (provide invoices),
- Conditions identical to the current standard warranty.

## 5. TROUBLESHOOTING

**CAUTION :**  
**OBSERVE ALL SAFETY WARNINGS CONTAINED IN THIS MANUAL.**

Problem	Possible origin	Possible solution
1. Pressure issue	Too much pressure drop.	To check pipes diameter.
	Relief valve damaged.	To check the opening point.
	No return valve damaged.	To check the proper operating of the No return valve.
2. Flow rate issue	Wrong Compressor speed.	To adjust the speed by taking care of the range allowed.
	Relief valve damaged.	To check the opening point.
3. Abnormal high temperature	Air filter clogged.	To clean the cartridge or to replace it.
	Air pressure too much high.	To see problems 1. / 2.
	Outside temperature too much high.	To respect the maximum external temperature allowed.
	Lack of oil.	To check the oil level.
	Compressor speed too much low.	To adjust the speed by taking care of the range allowed.
	The oil cooler fan does not turn.	Check the fuse and the fan motor.
4. Inlet pressure drop > 75 mbar (clogging indicator red)	Air filter clogged.	To clean the cartridge or to replace it.
	Air inlet hose folded.	To check the air inlet hose.
5. Compressor doesn't operate	Torque limiter damaged.	To replace the torque limiter.
	Transmission damaged.	To consult your Service point.
6. Torque limiter damaged	Screw Compressor damaged.	To consult your Service point.
	Wrong motor / transmission management.	To consult your Truck dealer.
	Oil too much viscous.	To be in compliance with the MOUVEX Instructions.
7. Oil leak	Too much oil.	To check the oil level.
	Oil breather clogged.	To clean the oil breather.
8. Vibrations	Wrong motor speed.	To increase the speed by taking care of the range allowed.
	Transmission damaged.	To check the driving shaft.
	Lack of rigidity of the chassis.	To be in compliance with the Truck Manufacturer Instructions.

## 6. STORAGE CONDITIONS

### 6.1 Compressor

The equipment must be systematically stored in an area sheltered from bad weather.

The equipment must bear its original protective components until it is installed in its final application.

If installation is interrupted, put back in place the original protective components or equivalent components.

### 6.2 BSC oil

In its unopened original container in a dry, frost-free and light-free place.

The maximum shelf life is approx. 60 months.

## 7. SCRAPPING



The compressor must be scrapped in compliance with the regulations in force.

During this operation, particular care must be paid to the drainage stages of the compressor.



## 8. COMPRESSORS FORM INFORMATION

Before any material return, it is required to get an authorization from MOUVEX.

 <p style="text-align: center;"><i>After Sales Department</i></p> <p style="font-size: small;">Z.I. La Plaine des Isles - 2 rue des Caillottes - 89000 AUXERRE - FRANCE ☎ +33 3 86 49 87 25 - <a href="mailto:sav.mouvex@psgdover.com">sav.mouvex@psgdover.com</a></p>	<h3 style="margin: 0;">COMPRESSORS FORM INFORMATION</h3>	
<p style="font-size: small; margin: 0;">In order to treat correctly the warranty claims, please first complete this information form. Thanks to return us this completed document by email as soon as possible.</p>		
<p style="font-size: small; margin: 0;">NAME, ADDRESS AND PHONE NUMBER OF THE CUSTOMER</p>		
<p style="font-size: small; margin: 0;"><u>Material purchased by :</u></p> <p>.....</p> <p>.....</p> <p>.....</p> <p>.....</p>	<p style="font-size: small; margin: 0;"><u>Material mounted by :</u></p> <p>.....</p> <p>.....</p> <p>.....</p> <p>.....</p>	<p style="font-size: small; margin: 0;"><u>Material used by :</u></p> <p>.....</p> <p>.....</p> <p>.....</p> <p style="font-size: x-small;">☛ Person to contact for technical information :</p> <p>.....</p> <p style="font-size: x-small;">☎ .....</p>
<p style="font-size: small; margin: 0;">EQUIPMENT CONCERNED</p>		
<p><input type="checkbox"/> Screw compressor    <input type="checkbox"/> Vane compressor    Type : .....</p> <p>Delivery date : ..... Starting-up date : .....</p> <p>Serial N° : ..... Running time estimation (hours) : .....</p> <p>Have you already replaced the equipment by a new one ?    <input type="checkbox"/> Yes    <input type="checkbox"/> No    ☛ If yes, indicate its serial N° : .....</p>		
<p style="text-align: center; font-size: small; margin: 0;">TYPE OF INSTALLATION</p> <p><input type="checkbox"/> Direct PTO drive</p> <p><input type="checkbox"/> Belt drive system</p> <p><input type="checkbox"/> Torque limiter (value) : .....</p> <p><input type="checkbox"/> Pressure relief valve setting (value) : .....</p> <p><input type="checkbox"/> Package DDNC      <input type="checkbox"/> Package DDIC</p> <p><input type="checkbox"/> Other (electric, diesel or hydraulic motor)</p> <p>☛ Brief description :</p> <p style="font-size: x-small; margin-left: 20px;">(please join a drawing or pictures of the installation)</p> <p>.....</p> <p>.....</p> <p>.....</p> <p>.....</p>	<p style="text-align: center; font-size: small; margin: 0;">OPERATING PARAMETERS</p> <p>☛ Compressor's speed : ..... rpm</p> <p>☛ Operating pressure : ..... bar</p> <p>☛ Motor speed at the time or the incident : ..... rpm</p> <p>☛ PTO ratio : .....</p> <p>☛ Product transfered : .....</p>	
<p style="text-align: center; font-size: small; margin: 0;">SUCTION CONDITIONS</p> <p><input type="checkbox"/> Air connection on truck chimney</p> <p><input type="checkbox"/> Direct air connection</p> <p><input type="checkbox"/> Flexible pipe between filter and compressor</p> <p><input type="checkbox"/> Stainless steel pipe between filter and compressor</p> <p><input type="checkbox"/> Filter type : .....</p>		
<p style="font-size: small; margin: 0;">DESCRIPTION OF THE MATTER</p>		
<p><input type="checkbox"/> Leakage                      <input type="checkbox"/> Insufficient flow                      <input type="checkbox"/> Insufficient pressure</p> <p><input type="checkbox"/> Blocking                      <input type="checkbox"/> Noise / vibration                      <input type="checkbox"/> Other : .....</p> <p>.....</p> <p>.....</p> <p>.....</p> <p>.....</p> <p>.....</p> <p>.....</p> <p>.....</p> <p>.....</p>		
 <p style="font-size: x-small; margin: 0;">IN CASE OF RETURN OF MATERIAL TO OUR FACTORY, PLEASE REQUEST IMPERATIVELY BEFORE SENDING THE MATERIAL RETURN AUTHORIZATION (RMA) WHICH WILL BE PROVIDED TO YOU BY MOUVEX AFTER SALES DEPARTMENT.</p>		

rev.10/06/2020