



INSTRUCTIONS 1002-C00 e

Section	1002
Effective	March 2017
Replaces	March 2016

Original instructions

S6C - S6C HP PUMPS



INSTALLATION

OPERATION

MAINTENANCE



Z.I. La Plaine des Isles - F 89000 AUXERRE - FRANCE
Tel. : +33 (0)3.86.49.86.30 - Fax : +33 (0)3.86.49.87.17
contact@mouvex.com - www.mouvex.com

Your distributor :

ECCENTRIC PISTON MOVEX PRINCIPLE

SAFETY, STORAGE, INSTALLATION AND MAINTENANCE INSTRUCTIONS S6C - S6C HP MODELS

USED PRESSURE UNITS

Unit without suffix :

Differential pressure, for example, pressure difference between equipment suction and discharge.

Unit with suffix "a" :

Absolute pressure.

Unit with suffix "g" :

Gauge pressure, given regarding to atmospheric pressure (~101325 Pa, taken at 1 bar / 14,5 psi in this IOM).

Example :

$P_{suc} = -0,2 \text{ barg} = 0,8 \text{ bara}$

$P_{dis} = 8,8 \text{ barg} = 9,8 \text{ bara}$

$\Delta P = P_{dis} - P_{suc} = 9 \text{ bar}$

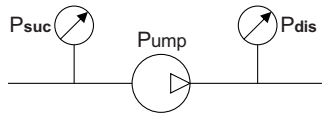

TECHNICAL CHARACTERISTICS

- Maximum speed : **530 rpm**
- Range of acceptable temperature :
FKM :
 - * **continuous**0° C to 80°C
 - * **washing / rinsing / sterilisation**0° C to 121°C
- Acceptable pressure to the suction :
 - * **minimum** : - 0,4 barg (0,6 bara)
 - * **maximum** : 3,0 barg (4,0 bara)
- Acceptable maximal differential pressure :
 - * **S6C** 6 bar*
 - * **S6C HP** 10 bar*
- Cylinder capacity :
 - * **S6C** 0,370 liter/rev.
 - * **S6C HP** 0,206 liter/rev.

* When the pump works with an inlet gauge pressure less than zero, the maximum outlet pressure will be calculated as if the inlet pressure is equal to zero.

TABLE OF CONTENTS

Page

1. OVERALL DIMENSIONS	3
2. INSTALLATION	4
2.1 Fixing to the ground of non-mobile units	4
2.2 Orientation of the pump ports	4
2.3 Direction of rotation	4
2.4 Protection of the installation	4
2.5 Unit assembly	4
3. USE	6
3.1 Commissioning	6
3.2 Dry running	6
3.3 Scrapping	6
4. CLEAN IN PLACE (CIP) & STERILISATION IN PLACE (SIP)	7
4.1 Preamble	7
4.2 Cleaning Out of place	7
4.3 Cleaning In Place	7
4.4 Sterilisation In Place (SIP)	8
5. ASSEMBLY / DISMANTLING	9
5.1 Necessary tools	9
5.2 Opening the pump	10
5.3 Dismantling the transmission block	10
5.4 Remounting the transmission block	10
5.5 Remounting the pump	10
6. MAINTENANCE	11
6.1 Checking of parts	11
6.2 Checking of seals	11
7. STORAGE	12
7.1 Short duration (≤ 1 month)	12
7.2 Long duration (> 1 month)	12
7.3 Restarting	12
8. CERTIFICATE OF CONFORMITY	13

Definition of safety symbols



This is a SAFETY ALERT SYMBOL.

When you see this symbol on the product, or in the manual, look for one of the following signal words and be alert to the potential for personal injury, death or major property damage.



Warns of hazards that **WILL** cause serious personal injury, death or major property damage.



Warns of hazards that **CAN** cause serious personal injury, death or major property damage.



Warns of hazards that **CAN** cause personal injury or property damage.

NOTICE

Indicates special instructions which are very important and must be followed.

2. INSTALLATION

2.1 Fixing to the ground of non-mobile units

The base plate is equipped with 3 fixed legs (height 92 mm) + 1 screw jack leg, all fixed under the base plate. These legs are made of an identical substance to that of the base plate.

2.2 Orientation of the pump ports

The suction port and the discharge port may be oriented in various positions (see overall dimensions plan).

If the port positions need to be changed at the time of installation, see the corresponding §.

The suction port may be oriented the top, the right or the left. Unless otherwise specified, the equipment is delivered with the suction port the right (for an observer facing the back of the pump).

The discharge port may be oriented at any angle around the pump's horizontal axis.

To orient the suction port
(cf. § DISMANTLING THE PUMP) :

Unscrew the 4 screws **002** at the back of the pump mounting bracket **001**. Orient the pumps' suction port **101** to the desired position. Screw back the 4 screws **002** at the back of the pump mounting bracket **001**.

To orient the discharge port :

Unscrew the 8 nuts **106** then remove the base **401**. Orient the base **401** to the desired position. Tighten the nuts **106**.

2.3 Direction of rotation



The S6C ou S6C HP pump only has one rotation direction (the pump not being reversible), clockwise (observer facing the back of the pump).



When connecting the motor, make sure, by observing the shaft, that the motor is turning in the correct direction.

An incorrect rotation direction will not damage the pump but it will not allow the unit to pump product.



2.4 Protection of the installation

In the case where valves are placed on the suction and discharge pipes, make sure that they cannot be closed without prior stopping of the pump.

	WARNING
	<p>PUMPS OPERATING AGAINST A CLOSED VALVE CAN CAUSE SYSTEM FAILURE, PERSONAL INJURY AND PROPERTY DAMAGE.</p>
<p>Hazardous pressure can cause personal injury or property damage.</p>	

	WARNING
	<p>FAILURE TO RELIEVE SYSTEM PRESSURE PRIOR TO PERFORMING PUMP SERVICE OR MAINTENANCE CAN CAUSE PERSONAL INJURY OR PROPERTY DAMAGE.</p>
<p>Hazardous pressure can cause personal injury or property damage.</p>	

The pump must be protected against excess pressure. It can be delivered with a pressure switch to ensure this function.



	WARNING
	<p>FAILURE TO INSTALL ADEQUATELY SIZED PRESSURE RELIEF VALVE(S) CAN CAUSE PROPERTY DAMAGE, PERSONAL INJURY OR DEATH.</p>
<p>Hazardous pressure can cause personal injury or property damage.</p>	



Also make sure that the pump and the installation are protected against any risk of deterioration through the passage of foreign bodies.

2.5 Unit assembly

The following instructions apply to pumps delivered with a bare shaft or for MOUVEX motor-driven pump units (if the latter have no specific instruction notice).

2.5.1 INSTALLATION OF UNITS

	WARNING
	<p>BE CAREFUL WITH THE WEIGHT OF THE PARTS WHEN THEY ARE BEING REMOVED.</p>
<p>The weight of the parts can be dangerous and may provoke bodily injuries or material damages.</p>	

	WARNING
	<p>DISCONNECT THE ELECTRICITY SUPPLY BEFORE ANY MAINTENANCE OPERATION.</p>
<p>Dangerous voltage. Can cause injury and death.</p>	

The base below the unit is fundamental to ensuring correct operation and long service life.

2. INSTALLATION (continued)

The unit's base must be flat, level and sufficiently resistant to absorb the stresses caused by the motor-driven pump unit without deformation (if it is made of concrete, it must comply with the BAEL 91 standard).



If the unit is fastened using securing lugs or bolts, it must be carefully wedged to avoid deforming the frame while the bolts are tightened. A deformed frame would apply damaging stresses on the pump and the drive mechanism and misalign the coupling, causing vibrations, noise and premature wear. Ensure that the frame is well above the floor, except from the support plates.



If the unit is to be used in a food environment, support plates that allow the unit to be lifted for easier cleaning are recommended.

Allow, if possible, a clear space of approximately 50 cm on each side of the motor-driven pump unit (overall dimensions) to facilitate cleaning and give access if necessary to the pump, reduction gear and motor fastening nuts. In all cases, the dimensions around the motor-driven pump unit must be designed to give the space required for dismantling the pump (if the need arises, use the values given on the overall dimension drawing).

For staff and equipment protection, the frame includes a ground connection point that should be used.

2.5.2 ALIGNMENT OF THE MOTOR/PUMP OR REDUCTION GEAR/PUMP SHAFTS

 WARNING		OPERATION WITHOUT THE SHAFT PROTECTOR CAN CAUSE SERIOUS PERSONAL INJURY, MAJOR PROPERTY DAMAGE OR DEATH.
 Do not operate without guard in place.		

 WARNING		DISCONNECT THE ELECTRICITY SUPPLY BEFORE ANY MAINTENANCE OPERATION.
Dangerous voltage. Can cause injury and death.		

NEVER START A UNIT IF THE COUPLING ALIGNMENT IS INCORRECT. THIS IS A CONDITION OF OUR GUARANTEE.

REMINDER :

Coupling must never be used to compensate for a misalignment.

To control the alignment between the coupling and the shaft, use a straight-edge for concentricity and thickness gauges for angular misalignment (see instructions of the coupling for authorised values).

The 3 figures below show in detail the operation and the possible defects :

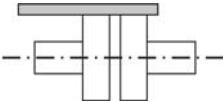
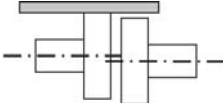
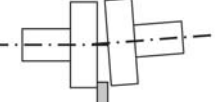
Make this check for 4 points: up - down - left - right	
	Correct
	Out-of-parallelism
	Angular defect



Controlling the alignment at each stage of the installation is important to be sure that none of these stages have generated stresses on the unit or the pump:

- after fastening on the foundations
- after fastening the pipes
- after the pump has been operated at the normal operating temperature

Where the pumps are supplied assembled as a unit, the motor and pump shafts have been perfectly aligned in the factory before delivery, but they must be systematically controlled on acceptance at the site and realigned if necessary.

To do this, do not modify the wedging of the various parts, but check the flatness of the support surface and use the adjustable foot to clear the frame of stresses that could affect it.

2.5.3 ELECTIC MOTORS

 WARNING		DISCONNECT THE ELECTRICITY SUPPLY BEFORE ANY MAINTENANCE OPERATION.
Dangerous voltage. Can cause injury and death.		



Check the compatibility of the instructions on the motor with the supply voltage.

Follow the wiring diagram, use wiring that is appropriate for the power and be particularly careful about the contacts which must be well tightened.

The motors should be protected with circuit breakers and suitable fuses. Connect the regulatory electrical grounding.

2. INSTALLATION (suite)



2.5.4 THERMIC MOTORS



	CAUTION
	<p>THE SURFACES CAN BE AT A TEMPERATURE LIABLE TO CAUSE INJURY OR SEVERE DAMAGE.</p>
<p>Excessive temperature- can cause injury or severe damage.</p>	



Do not forget that these motors are not reversible. It is absolutely necessary to carefully control the suction and discharge sides of the pump before connecting the group to the piping.

Using electric motors is very common now; however, we strongly advise careful reading of the accompanying instruction manual.

2.5.5 CONTROL OF THE SENSE OF ROTATION

	WARNING
	<p>TAKE ALL NECESSARY MEASURES TO RENDER ANY START-UP, EVEN ACCIDENTAL, OF THE PUMP DURING THE WORK IMPOSSIBLE.</p>
<p>Any unforeseen start-up can cause serious injuries or important material damages.</p>	

	WARNING
	<p>HYDRAULIC PRESSURE MUST BE FULLY RELEASED BEFORE MAINTENANCE OPERATIONS IN ORDER TO PREVENT PERSONAL INJURY OR PROPERTY DAMAGE.</p>
<p>Hazardous pressure can cause personal injury or property damage.</p>	

	WARNING
	<p>A DRIVE SHAFT GUARD BETWEEN THE PTO AND PUMP MUST BE PROVIDED TO PREVENT PERSONAL INJURY, PROPERTY DAMAGE OR DEATH.</p>
<p>Do not operate without guard in place.</p>	

This control needs to be done with no liquid pumped through the pump, and both the suction and discharge circuits venting to avoid generating unexpected pressure (at the suction side, for example). This will ensure that the control will not damage either the pump or the installation.

Start the pump empty to check that the connections are good and that the direction of rotation corresponds to the suction and discharge direction on the installation. If it is necessary to reverse the direction of rotation, follow the instructions below :

Three-phase motor : switch any 2 current input wires.

Bi-phase motor : switch two same phase wires.

Single-phase motor : follow the instructions on the notice supplied with the motor.

3. USE

3.1 Commissioning

Before starting-up the pump, rinse the whole installation so as to eliminate any contaminants that may remain in the pipes, tanks etc. at the time of installation, **taking care to bypass the pump.**

For any pure water pumping during process or cleaning operations, consult Movex imperatively.

3.2 Dry running

The pump may run dry for a maximum duration of 5 minutes.

At priming :

From a practical point of view, the time necessary for priming is much lower than this value.

If, after a period of 1 min., the product is still not in the body of the pump, we recommend reconsidering the installation at the suction section.

Draining of pipes (suction & discharge) :

A compressor effect close to 3 bar is obtained for a period of 3 minutes. After that, the value falls to 0.5 bar as the lubrication ensured by the pumped product rapidly disappears from between the piston and the cylinder.

3.3 Scrapping

The pump must be scrapped in compliance with the regulations in force.

During this operation, particular care must be paid to the drainage stages of the pump (pumped product) and of its transmission (lubricant).

4. CLEAN IN PLACE (CIP) & STERILISATION IN PLACE (SIP)

4.1 Preamble



S-Series pumps have been designed to permit an easy cleaning with CIP procedure. However, this cleaning might not be compliant with some high hygienic standards and should then be replaced by a hand cleaning (also called Cleaning Out Place or COP) when application require a cleaning in compliance with the strictest hygienic standards.



NOTICE

Check that the chemical solutions making up the cleaning solution are totally compatible with the Elastomer of the S-series pump's transmission (FKM).

NOTICE

Although a particular care was taken to cleanliness when assembling the pump, we recommend to carry out a cleaning of the pump before any use.

	WARNING	<p>IF PUMPING HAZARDOUS OR TOXIC FLUIDS, THE SYSTEM MUST BE FLUSHED PRIOR TO PERFORMING ANY SERVICE OPERATION.</p>
		
<p>Hazardous or toxic fluids can cause serious injury.</p>		

	WARNING	<p>FAILURE TO RELIEVE SYSTEM PRESSURE PRIOR TO PERFORMING PUMP SERVICE OR MAINTENANCE CAN CAUSE PERSONAL INJURY OR PROPERTY DAMAGE.</p>
		
<p>Hazardous pressure can cause personal injury or property damage.</p>		

4.2 Cleaning Out of place

Please refer to the § ASSEMBLY / DISMANTLING of the pump, while taking care to avoid any dropping or any bumping of the parts as this could damage them.

4.3 Cleaning In Place

S-Series pumps are perfectly adapted to all processes necessitating a CIP.

S SERIES PUMPS MUST NEVER BE USED AS CIP PUMPS.

A centrifugal pump will be used for this purpose and must be placed upstream of the S6C pump. The useful CIP flow discharged by the centrifugal pump must be 30-35 m³/h.

The CIP pump **must be** installed in series with the S6C pump (see fig. 1) or the couple piston/cylinder risks being damaged.

Figure 1

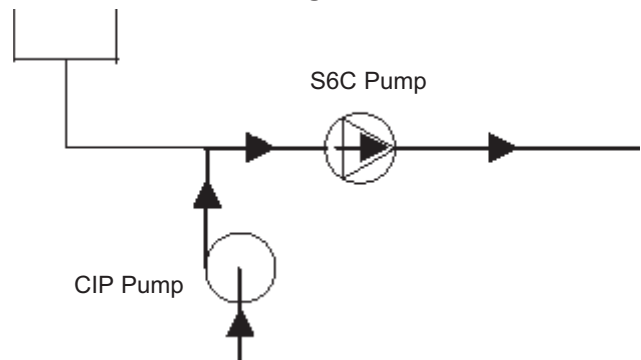

It is preferable not to run the S Series pump during CIP although low speed (< 100 rpm) is acceptable by alternating start/stop operation.

During CIP, the S6C pump is flushed through. Indeed, the pressure at entry to the pump is higher than the exit pressure, the piston lifts off from the cylinder and enables complete circulation of the cleaning liquid through the S6C pump (see fig. 2).

Figure 2

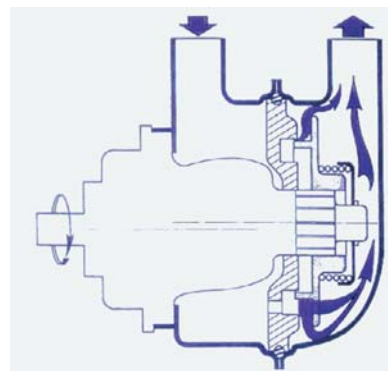

4. CLEAN IN PLACE (CIP) & STERILISATION IN PLACE (SIP) (continued)

The centrifugal pump delivering the washing solution is generally calibrated to a higher throughput than 10 m³/h, therefore a pump bypass circuit must be provided for (see fig.3).

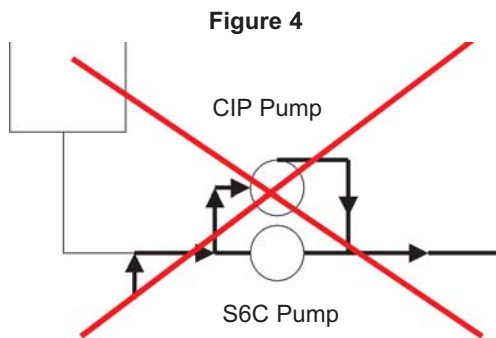
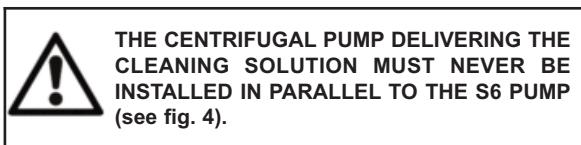
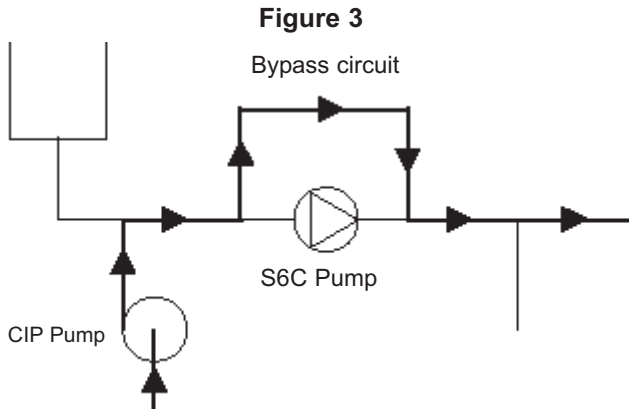



Indeed, in this case, the pressure at entry to the S6C pump is lower than the exit pressure and the piston remains stuck against the cylinder. The S6C pump is not flushed through. Its good cleaning is therefore no longer ensured and the cylinder/piston couple will be prematurely worn.



In the case of assembly in "parallel" (discharge of the centrifuge pump to the discharge of the S6C pump), the 2 pumps must never be run at the same time. In this case the S6C pump cleans itself.



4.4 Sterilisation In Place (SIP)



The serie S pumps are perfectly adapted to all processes using SIP (Sterilisation In Place): pump stopped / maximum 20 mn per cycle / 1 or 2 cycles per day.



5. ASSEMBLY / DISMANTLING



	WARNING	
		TAKE ALL NECESSARY MEASURES TO RENDER ANY START-UP, EVEN ACCIDENTAL, OF THE PUMP DURING THE WORK IMPOSSIBLE.
		Any unforeseen start-up can cause serious injuries or important material damages.

	WARNING	
		DISCONNECTING THE FLUID OR PRESSURE CONTAINMENT COMPONENTS DURING PUMP OPERATION CAN CAUSE SERIOUS PERSONAL INJURY, DEATH OR MAJOR PROPERTY DAMAGE.
		Hazardous pressure can cause personal injury or property damage.

	WARNING	
		FAILURE TO RELIEVE SYSTEM PRESSURE PRIOR TO PERFORMING PUMP SERVICE OR MAINTENANCE CAN CAUSE PERSONAL INJURY OR PROPERTY DAMAGE.
		Hazardous pressure can cause personal injury or property damage.

	WARNING	
		IF PUMPING HAZARDOUS OR TOXIC FLUIDS, THE SYSTEM MUST BE FLUSHED PRIOR TO PERFORMING ANY SERVICE OPERATION.
		Hazardous or toxic fluids can cause serious injury.

	WARNING	
		BE CAREFUL WITH THE WEIGHT OF THE PARTS WHEN THEY ARE BEING REMOVED.
		The weight of the parts can be dangerous and may provoke bodily injuries or material damages.

	CAUTION	
		THE PUMP LUBRICANT IS VERY SLIPPERY AND MAY CAUSE SERIOUS INJURY. ANY SPILLS MUST BE CLEANED UP.
		Slippery lubricant. Spills should be cleaned up.

Before any dismantling, make sure that the pump has been drained and take all necessary measures to avoid its start-up. No start-up, even accidental, must be possible.

5.1 Necessary tools

- Wrench no. 13
- Wrench no. 16
- Wrench no. 19
- Plastic mallet
- Hexagonal socket wrench no. 6

Assembly torques :

- M8 : 23,7 Nm
- M10 : 30 Nm
- M12 : 50 Nm

5. ASSEMBLY / DISMANTLING (continued)

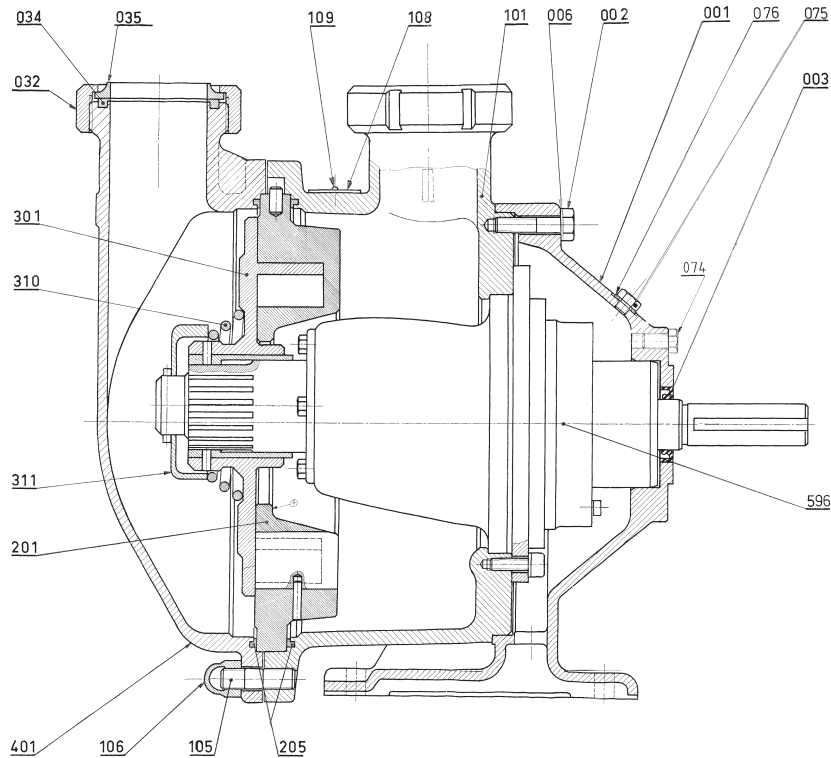

5.2 Opening the pump

Disconnect the pump from the discharge pipe.

Remove the base **401** : unscrew the 8 nuts **106**.

Remove the pressure of the spring **311** by pushing it towards the piston **301** and swivelling it to free it as well as the spring support **310**.

Pull the piston **301** out by holding it by its circumference. In the case where the piston remains stuck after pumping a viscous or sticky product, use of a hub puller is advised. This operation can be eased by lightly tapping the external surface of the piston with the help of a plastic mallet.

Remove the cylinder **201** and the seals **205**.

At this stage of dismantling, a visual check of the state of the transmission block **596** can be carried out. The transmission block is a wearing part. In preventive maintenance, it can be changed every 5000 running hours (see § MAINTENANCE).

5.3 Dismantling the transmission block

Disconnect the pump from the drive device, unscrew the pump mounting bracket **001** from the base plate of the pump then separate it from the pump by unscrewing the 4 screws **002**.

Unscrew the 10 screws **750**, separate the main body **101** from the transmission block by screwing 2 M8 screws in the 2 diametrically opposed M8 internal threads in the transmission block flange (so as to progressively eject the main body **101**).

5.4 Remounting the transmission block

Proceed in the reverse order from the preceding chapter taking care to correctly orient the main body **101**.

All screws must be degreased and mounted with a medium thread locking adhesive (LOCTITE® 243* for example).

Caution : The assembly torque must be applied progressively in opposition.

Assembly torque: M8 : 23,7 Nm.

5.5 Remounting the pump

Replace the cylinder **201** and the seal **205** so that the dowel **223** penetrates in the notch of the main body.

CAUTION
Incorrect mounting of the cylinder may lead to deterioration of the pump.

Engage the piston **301** on the transmission block, the piston gap facing the cylinder partition.

Give a small push (contrary to the eccentricity of the grooved hub of the transmission block) to the piston to centre it and engage it in the cylinder. Then, push it tight in taking care to correctly engage the female profile of the piston splines on the male of the transmission assembly.

Put the pressure spring at the back of the piston **310** then the hand nut **311**.

Re-mount the base **401** and the seal **205** taking care to give the discharge port the desired angular position.

* Loctite® is a registered trademark.

6. MAINTENANCE

During all dismantling and re-mounting operations, take care to protect the parts against any dropping or bumping that might damage them.

6.1 Checking of parts

6.1.1 Cylinder and piston

The piston **301** and the cylinder **201** are active parts (wear parts) on which the pump's efficiency directly depends. It is therefore advisable to regularly check the pump's efficiency and replace the cylinder / piston if it decreases.

In addition, as using a cylinder / piston that is too worn may damage the pump's transmission system, it is advisable to replace the cylinder / piston if the maximum acceptable wear dimensions defined in the table below are reached.

		Piston 301 mm (inch)	Cylinder 201 mm (inch)
S6	New dimension	8 (0,315)	50 (1,969)
	Minimum wear dimension acceptable	4 (0,157)	46 (1,811)
S6 HP	New dimension	8 (0,315)	30 (1,181)
	Minimum wear dimension acceptable	4 (0,157)	26 (1,024)

As changes in the pump's efficiency depend on the conditions of use (pressure, rotation speed, liquid pumped, etc.), MOUVEX recommends that users define the monitoring ranges and the preventive maintenance schedule according to their own experience.

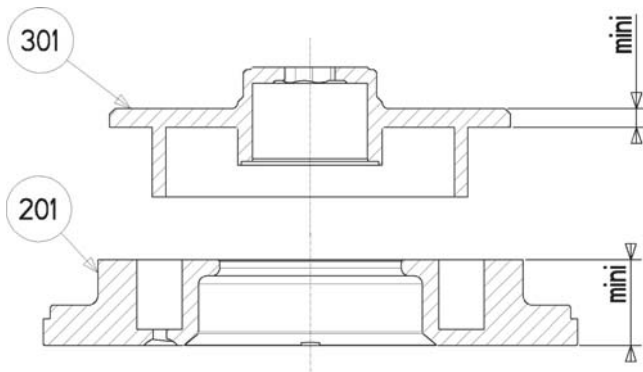

NOTICE

When disassembling the piston nut 304, if the enclosed thread surfaces have become soiled, we recommend cleaning them as follows : clean the inner thread by washing, rinsing and sterilizing the whole part (i.e. with a steam sterilization), then remove any impurities from the external threads by washing with a brush followed by rinsing with a bactericide solution before re-assembly.

6.1.2 Checking of piston bushing wear

Proceed as follows :

The transmission block being held still, place the piston on the piston hub, taking care that the front faces of splined hub and piston are on the same level.

Rotate piston by hand from right to left and vice versa up to the point where it is stopped by hub splines. Then measure the distance between the 2 most extreme positions.

This distance is proportional to the clearance between the splines.

Replace the set cylindre/piston if the distance (d) (measured on the piston periphery) exceeds the maximal distance given in the table :

Pump	S2	S4	S6
Max distance (mm)	2,5	2,5	4

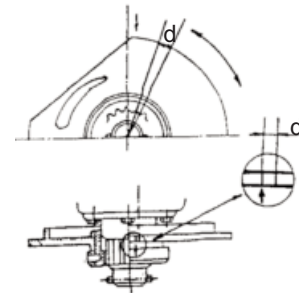

d : measured distance

6.2 Checking of seals



Seals material are intended for use in normal conditions in food process. In order to ensure a reliable sealing on S series pumps we recommend to :

- do an inspection of the seals every three months (this time could be shorter if using the pump in hard conditions. Contact the manufacturer for advice if necessary).
- replace the pump sealing every two years.

7. STORAGE

If necessary, refer to § ASSEMBLY / DISMANTLING for pump disassembly.

7.1 Short duration (≤ 1 month)

	WARNING	IF PUMPING HAZARDOUS OR TOXIC FLUIDS, THE SYSTEM MUST BE FLUSHED PRIOR TO PERFORMING ANY SERVICE OPERATION.
		
Toxic or hazardous fluids can cause serious injury.		

MOUVEX pumps and motor-driven pumps are well lubricated when delivered to protect the internal parts during brief storage in a building where :

- the temperature remains between 10°C and 50°C.
- the relative humidity does not exceed 60%.
- exposure to vibration is limited.
- pump is stored in an area sheltered from bad weather and sun.

7.2 Long duration (> 1 month)

The recommendations from the manufacturer should be followed if the pump is stored with its gear motor.

Pump ports should be filled with a non-corrosive liquid that it compatible with the pump components in order to prevent corrosion.

Unpainted external surfaces of the pump (e.g. shafts, couplings, etc.) should be covered in some form of anti-corrosion protection.

The best storage conditions are inside a building that meets the conditions set out above.

If inside storage is not possible, the materials should be covered to prevent direct exposure to sun and bad weather. This protection should also prevent condensation.

Rotate pump shaft manually a few revolutions every two months.

7.3 Restarting

Follow the standard start-up procedure for the pump/ motor-driven pump, as well as the instructions below.

Turn the pump by hand to make sure the parts move freely.

Control transmission sleeve which must not show any visible damage :

- Cracks
- Vulcanization
- Deformation
- Discoloration
- Etc.

Do not attempt to remove the sleeve or to empty the oil from it. This operation can only be done in the factory.

If in doubt, replace the complete transmission.



DECLARATION UE DE CONFORMITE EU CERTIFICATE OF CONFORMITY – EU KONFORMITÄTSSERKLÄRUNG



MOUVEX sas, ZI La Plaine des Isles – 2 Rue des Caillottes – 89000 Auxerre France, déclare que l'équipement suivant / declares the following equipment / erklärt, dass folgende Ausrüstung:

Modèle : _____ (A) Répondant aux spécifications indiquées dans l'ARC N° : _____ (B)
Designation / Bezeichnung Serial N° / Serien Nr. According to the specifications recorded in the acknowledgment of order N°:
Entsprechend den Spezifikationen aus AB-Nr.:

Pour la Sté MOUVEX sas, fait à Auxerre le : _____
For Mouvex sas company – Date : _____
Für die Fa Mouvex sas - Datum : _____

Responsible Quality Manager / Qualitätsbeauftragter

- Configuration :**
Konfiguration
- Pompe / Compresseur arbre nu
(Pump / Compressor « bare-shaft »)
(Pumpe / Kompressor, freies Wellenende)
- Groupe de pompage / de compression
(Pumping Unit / Compressor Unit)
(Pumpen- / Kompressoraggregat)
- Type / Geräteart :**
- Pompe à mvt excentré (Eccentric Disc Pump / Ringkolbenpumpe)
- Pompe péristaltique (Peristaltic Pump / Schlauchpumpe)
- Pompe centrifuge (Centrifugal Pump / Kreiselpumpe)
- Compresseur à Vis (Screws compressor / Schraubenverdichter)
- Compresseur à palettes (Vaned compressor / Flügelzellenverdichter)
- Refroidisseur Hydraulique (Hydraulic oil cooler / Hydraulikkühler)
- Pompe à lobes (Lobes Pump / Drehkolbenpumpe)
- Pompe à palettes (Vaned Pump / Flügelzellenpumpe)
- Autre pompe (Other Pump / Andere Pumpe)

Est conforme aux dispositions suivantes :

Directive « MACHINES » 2006/42/CE et aux législations nationales la transposant, portant sur les dispositifs de sécurité liés aux risques mécaniques et électriques applicables aux machines tournantes.
NF EN 809:2009 NF EN 1672-2:2009 NF EN ISO 13857:2008 NF EN 12162:2009

Directive « ATEX » 2014/34/UE du 26 février 2014 et aux législations nationales la transposant, portant sur les appareils destinés à être utilisés en atmosphères explosibles. Conformité obtenue par application des normes :
NF EN 1127-1:1997 NF EN 13463-1:2009 NF EN 13463-5:2009
Certification ATEX délivrée par INERIS*, Organisme Certificateur, et portant le marquage suivant : (C)

Is in conformity with the provisions of the following Directive:

« MACHINES » Directive 2006/42/EEC as transposed by the national legislation, concerning safety equipments and arrangements relative to mechanical and electric risks applicable to rotative machines.
NF EN 809:2009 NF EN 1672-2:2009 NF EN ISO 13857:2008 NF EN 12162:2009

« ATEX » Directive 2014/34/EU (26 Feb. 2014) as transposed by the national legislation, concerning equipment intended to be used in explosive atmospheres. Conformity obtained by application of the standards :
NF EN 1127-1:1997 NF EN 13463-1:2009 NF EN 13463-5:2009
ATEX Certification delivered by INERIS*, Notified Body, and with the following marking: (C)

den Bestimmungen der nachstehenden Richtlinien entspricht:

«Maschinen-Richtlinie» 2006/42/EEC wie umgesetzt im nationalen Recht hinsichtlich der Ausrüstungssicherheit und Sicherheitsvorkehrungen bezogen auf mechanische und elektrische Risiken, die für rotierende Maschinen gelten.
NF EN 809:2009 NF EN 1672-2:2009 NF EN ISO 13857:2008 NF EN 12162:2009

„ATEX“ Richtlinie 2014/34/EU (26. Feb. 2014) wie umgesetzt im nationalen Recht in Bezug auf Ausrüstungen für den Einsatz in explosionsgefährdeter Atmosphäre. Die Konformität hat Geltung durch Anwendung folgender Normen:
NF EN 1127-1:1997 NF EN 13463-1:2009 NF EN 13463-5:2009
Die ATEX-Zertifizierung wurde von der benannten Stelle INERIS* erteilt, und mit folgender Kennzeichnung: (C)

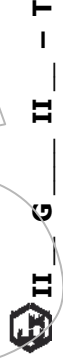

Temp Max produit pompé / Max Temp Flow / Max. T° Medium = _____ °C (X = voir notice / see IOM / siehe Handbuch)

L'équipement désigné ci-dessus doit impérativement respecter les conditions d'utilisation ATEX décrites dans nos notices d'instruction. Il doit être employé conformément à l'utilisation qui en a été prévue de par sa conception et sa fabrication, et conformément aux normes en vigueur. Nous, soussignés, déclarons que l'équipement concerné est conforme aux Directives listées ci-dessus et aux normes applicables s'y rapportant.

The equipment indicated above must imperatively comply with the ATEX conditions of use described in our instruction book. It must be used according to the foreseen use by its design and its manufacturing, and according to the current standards. We, undersigned, declare that the concerned equipment is in conformity with the Directives listed above and in the applicable standards in force.

Oben stehend bezeichnete Ausrüstung muss unbedingt den in unseren Betriebsanleitungen beschriebenen ATEX Anwendungsbedingungen entsprechen. Sie ist entsprechend dem durch Konstruktion und Fabrikation vorgesehenen Verwendungszweck und entsprechend den geltenden Normen einzusetzen. Die Unterzeichner erklären, dass die bezeichnete Ausrüstung den oben aufgeführten Richtlinien und den diesbezüglich geltenden Normen entspricht.

CTRL-D025 – rév.04 du 25/05/2016 – Déclaration de conformité CE-Atex

* (INERIS – Parc Techno Alata – 60550 Verneuil-en-Halatte – France).