

### CHARACTERISTICS

	STANDARD	AVAILABLE OPTIONS
Technology	API-674 Reciprocating Pump	
No. of plungers	3	
Plunger diameter mm	25/28/31/35/40/45/50/55	High pressure: 16/18/20/22
Plunger stroke mm	60	
Valve type	Disc type	
Lubrication type	Splash lubrication	Positive pressure
Leakage rate	< 2.0 L/h	Seal oil system
Weight kg (lbs)	290 (639)	

### FLOW RATE

Plunger diameter mm	Flow rate @100 rpm L/min (GPM)	MAWP Bar (psi)
55	39.8 (10.5)	85 (1233)
50	32.9 (8.7)	100 (1450)
45	26.3 (6.9)	125 (1813)
40	20.6 (5.4)	155 (2248)
35	16.1 (4.3)	205 (2973)
31	12.4 (3.3)	260 (3771)
28	9.9 (2.6)	320 (4641)
25	7.5 (2.0)	380 (5511)

### DIMENSIONS mm (in.)

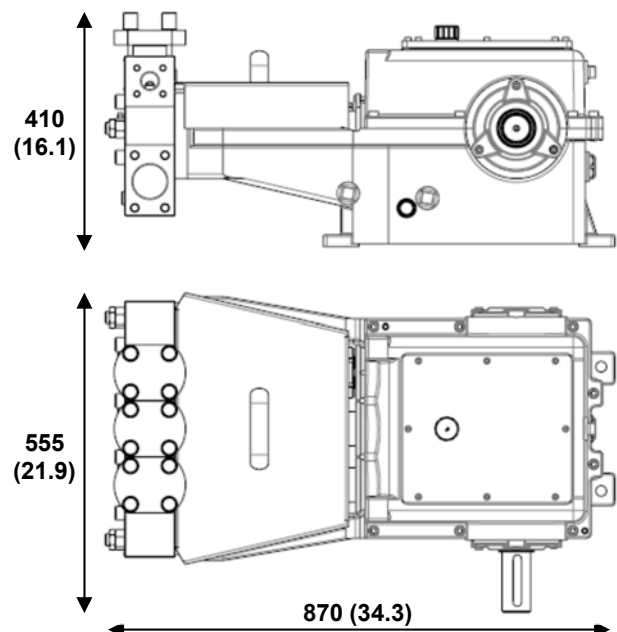

### OPERATING LIMITS

Minimum temperature °C (°F)	20 (68)
Maximum temperature °C (°F)	200 (392)
Maximum viscosity cSt	100
Maximum differential pressure bar (psi)	In high pressure configuration: 900 (13053)
Design speed rating rpm	575
API 674 speed rating rpm	432
Maximum absorbed power kW (HP)	36.7 (48.3)
Max. allowable plunger load kg (lbs)	1952 (4303)
Maximum solid particle size µm (in.)	100 (0.004)

### MATERIALS OF CONSTRUCTION

Part No	PART NAME	STANDARD MATERIALS	AVAILABLE OPTIONS
25210	Crankshaft	AISI 1045	
25310	Power end casing	Cast iron	
25401	Cylinder	C55 with Kanigen®	AISI 316L / Duplex / Super-duplex
25450	Valves	AISI 630	Duplex / Super-duplex
25500	Stuffing boxes	AISI 420 with Kanigen®	AISI 316L / Duplex / Super-duplex
25509	Plungers	AISI 630	Duplex / Super-duplex
	Plungers treatment	Chromium carbide	Tungsten carbide / Colmonoy®
	Seal Rings	PA 6.6	PEEK
	Lubricant	Mineral oil	

