

WILDEN[®]
Part of Pump Solutions Group
A **DOVER** COMPANY

EOM
Engineering
Operation &
Maintenance

P800/PX800
Advanced™ Series
Metal Pumps

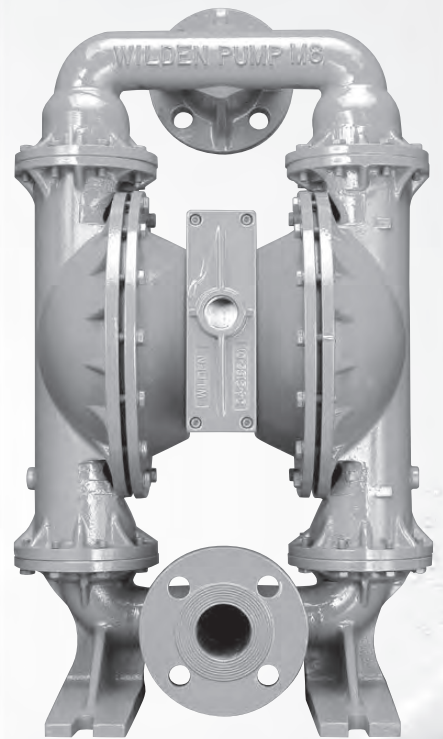

Where Innovation Flows

www.wildenpump.com

PROFLO[™]
PROGRESSIVE PUMP TECHNOLOGY

PROFLO[™] X CE
PROGRESSIVE PUMP TECHNOLOGY

WIL-11220-E-14
REPLACES WIL-11220-E-13

TABLE OF CONTENTS

SECTION 1 CAUTIONS—READ FIRST! 1

SECTION 2 WILDEN PUMP DESIGNATION SYSTEM 2

SECTION 3 HOW IT WORKS—PUMP & AIR DISTRIBUTION SYSTEM 3

SECTION 4 DIMENSIONAL DRAWINGS 4

SECTION 5 PERFORMANCE

 A. P800 Performance

 Rubber-Fitted 7

 TPE-Fitted 7

 Reduced-Stroke PTFE-Fitted 8

 Full-Stroke PTFE-Fitted 8

 Ultra-Flex™ -Fitted 9

 Suction-Lift Curves 9

 B. PX800 Performance

 Operating Principle 12

 How to Use this EMS Curve 13

 Performance Curves

 Rubber-Fitted 16

 TPE-Fitted 17

 Reduced-Stroke PTFE-Fitted 18

 Full-Stroke PTFE-Fitted 19

 Ultra-Flex™ -Fitted 20

 Suction-Lift Curves 26

SECTION 6 SUGGESTED INSTALLATION, OPERATION & TROUBLESHOOTING 28

SECTION 7 DISASSEMBLY / REASSEMBLY 31

SECTION 8 EXPLODED VIEW & PARTS LISTING

 P800 Aluminum

 Rubber/TPE/PTFE/Ultra-Flex™ -Fitted 38

 P800 Stainless Steel

 Rubber/TPE/PTFE/Ultra-Flex™ -Fitted 40

 PX800 Aluminum

 Rubber/TPE/PTFE/Ultra-Flex™ -Fitted 42

 PX800 Stainless Steel

 Rubber/TPE/PTFE/Ultra-Flex™ -Fitted 44

SECTION 9 ELASTOMER OPTIONS 49

CAUTIONS—READ FIRST!



CAUTION: Do not apply compressed air to the exhaust port — pump will not function.



CAUTION: Do not, under any circumstance loosen the set screw located at the adjuster dial of the Pro-Flo X™ pump. If the set screw is loose when the pump is pressurized, it could eject and cause injury to anyone in the area.



CAUTION: Do not over-lubricate air supply — excess lubrication will reduce pump performance. Pump is pre-lubed.



TEMPERATURE LIMITS:

Polypropylene	0°C to 79°C	32°F to 175°F
PVDF	-12°C to 107°C	10°F to 225°F
PFA	7°C to 107°C	20°F to 225°F
Neoprene	-18°C to 93°C	0°F to 200°F
Buna-N	-12°C to 82°C	10°F to 180°F
EPDM	-51°C to 138°C	-60°F to 280°F
Viton® FKM	-40°C to 177°C	-40°F to 350°F
Wil-Flex™	-40°C to 107°C	-40°F to 225°F
Saniflex™	-29°C to 104°C	-20°F to 220°F
Polyurethane	-12°C to 66°C	10°F to 150°F
Polytetrafluoroethylene (PTFE) ¹	4°C to 104°C	40°F to 220°F
Nylon	-18°C to 93°C	0°F to 200°F
Acetal	-29°C to 82°C	-20°F to 180°F
SIPD PTFE with Neoprene-backed	4°C to 104°C	40°F to 220°F
SIPD PTFE with EPDM-backed	-10°C to 137°C	14°F to 280°F
Polyethylene	0°C to 70°C	32°F to 158°F
Geolast®	-40°C to 82°C	-40°F to 180°F

¹4°C to 149°C (40°F to 300°F) - 13 mm (1/2") and 25 mm (1") models only.

NOTE: Not all materials are available for all models. Refer to Section 2 for material options for your pump.



CAUTION: When choosing pump materials, be sure to check the temperature limits for all wetted components. Example: Viton® has a maximum limit of 177°C (350°F) but polypropylene has a maximum limit of only 79°C (175°F).



CAUTION: Maximum temperature limits are based upon mechanical stress only. Certain chemicals will significantly reduce maximum safe operating temperatures. Consult Chemical Resistance Guide (E4) for chemical compatibility and temperature limits.



WARNING: Prevent static sparking. If static sparking occurs, fire or explosion could result. Pump, valves and containers must be grounded to a proper grounding point when handling flammable fluids and whenever discharge of static electricity is a hazard.



CAUTION: Do not exceed 8.6 bar (125 psig) air-supply pressure.



CAUTION: The process fluid and cleaning fluids must be chemically compatible with all wetted pump components. Consult Chemical Resistance Guide (E4).



CAUTION: Do not exceed 82°C (180°F) air inlet temperature for Pro-Flo X™ models.



CAUTION: Pumps should be thoroughly flushed before installing into process lines. FDA- and USDA-approved pumps should be cleaned and/or sanitized before being used.



CAUTION: Always wear safety glasses when operating pump. If diaphragm rupture occurs, material being pumped may be forced out air exhaust.



CAUTION: Before any maintenance or repair is attempted, the compressed air line to the pump should be disconnected and all air pressure allowed to bleed from pump. Disconnect all intake, discharge and air lines. Drain the pump by turning it upside down and allowing any fluid to flow into a suitable container.



CAUTION: Blow out air line for 10 to 20 seconds before attaching to pump to make sure all pipeline debris is clear. Use an in-line air filter. A 5µ (micron) air filter is recommended.



NOTE: When installing PTFE diaphragms, it is important to tighten outer pistons simultaneously (turning in opposite directions) to ensure tight fit. (See torque specifications in Section 7.)



NOTE: Cast Iron PTFE-fitted pumps come standard from the factory with expanded PTFE gaskets installed in the diaphragm bead of the liquid chamber. PTFE gaskets cannot be re-used. Consult PS-TG for installation instructions during reassembly.



NOTE: Before starting disassembly, mark a line from each liquid chamber to its corresponding air chamber. This line will assist in proper alignment during reassembly.



CAUTION: Pro-Flo® pumps cannot be used in submersible applications. Pro-Flo X™ is available in both single-point exhaust (submersible) and standard (non-submersible) options. Do not use standard Pro-Flo X™ models in submersible applications. Turbo-Flo® pumps are also available in a single-point exhaust (submersible) configuration.



CAUTION: Tighten all hardware prior to installation.



WILDEN PUMP DESIGNATION SYSTEM

P800/PX800 METAL

**51 mm (2") Pump
Maximum Flow Rate:
674 lpm (178 gpm)**

LEGEND

P800 / XXXXX / XXX / XX / XXX / XXXX

MODEL

WETTED PARTS & OUTER PISTON
AIR CHAMBERS
CENTER BLOCK
AIR VALVE

DIAPHRAGMS

VALVE BALLS

O-RINGS

VALVE SEAT

SPECIALTY CODE
(if applicable)

MATERIAL CODES

MODEL

P800 = PRO-FLO®
PX800 = PRO-FLO X™
XPX800 = PRO-FLO X™ ATEX

WETTED PARTS & OUTER PISTON

AA = ALUMINUM / ALUMINUM
HH = ALLOY C / ALLOY C
SS = STAINLESS STEEL
STAINLESS STEEL

AIR CHAMBERS

A = ALUMINUM
C = PTFE-COATED
N = NICKEL-PLATED
S = STAINLESS STEEL
V = HALAR®-COATED
ALUMINUM (P800 only)

CENTER BLOCK

A = ALUMINUM (PX800 only)
N = NICKEL-PLATED
(PX800 only)
P = POLYPROPYLENE
S = STAINLESS STEEL
(PX800 only)

AIR VALVE

A = ALUMINUM (PX800 only)
N = NICKEL-PLATED
(PX800 only)
P = POLYPROPYLENE
S = STAINLESS STEEL
(PX800 only)

DIAPHRAGMS

BNS = BUNA-N (Red Dot)
BNU = BUNA-N, ULTRA-FLEX™
FSS = SANIFLEX™
[Hytrel® (Cream)]
FWS = SANITARY WIL-FLEX™,
EZ-INSTALL [Santoprene®
(Two Orange Dots)]
EPS = EPDM (Blue Dot)
EPU = EPDM, ULTRA-FLEX™
NES = NEOPRENE (Green Dot)
NEU = NEOPRENE, ULTRA-FLEX™
PUS = POLYURETHANE (Clear)
TEU = PTFE W/EPDM
BACK-UP (White)
TNU = PTFE W/NEOPRENE
BACK-UP (White)
TSS = FULL-STROKE PTFE
W/SANIFLEX™ BACK-UP
TSU = PTFE W/SANIFLEX™
BACK-UP (White)
TWS = FULL-STROKE PTFE
W/WIL-FLEX™ BACK-UP
VTS = VITON® (White Dot)
VTU = VITON®, ULTRA-FLEX™
WFS = WIL-FLEX™ [Santoprene®
(Orange Dot)]
XBS = CONDUCTIVE BUNA-N
(Two Red Dots)
ZGS = GEOLAST®, EZ-INSTALL
ZPS = POLYURETHANE,
EZ-INSTALL
ZSS = SANIFLEX™, EZ-INSTALL
ZWS = WIL-FLEX™, EZ-INSTALL

VALVE BALL

BN = BUNA-N (Red Dot)
EP = EPDM (Blue Dot)
FS = SANIFLEX™ [Hytrel® (Cream)]
FW = SANITARY WIL-FLEX™
[Santoprene® (Two Orange
Dots)]
NE = NEOPRENE (Green Dot)
PU = POLYURETHANE (Brown)
TF = PTFE (White)
VT = VITON® (Silver
or White Dot)
WF = WIL-FLEX™ [Santoprene®
(Orange Dot)]

VALVE SEAT

A = ALUMINUM
BN = BUNA-N (Red Dot)
EP = EPDM (Blue Dot)
FS = SANIFLEX™ [Hytrel® (Cream)]
FW = SANITARY WIL-FLEX™
[Santoprene® (Two Orange
Dots)]
H = ALLOY C
NE = NEOPRENE (Green Dot)
M = MILD STEEL
PU = POLYURETHANE (Brown)
S = STAINLESS STEEL
VT = VITON® (Silver
or White Dot)
WF = WIL-FLEX™ [Santoprene®
(Orange Dot)]

VALVE SEAT O-RING

TF = PTFE

SPECIALTY CODES

0044 Stallion, balls & seats ONLY
0100 Wil-Gard 110V
0102 Wil-Gard sensor wires ONLY
0103 Wil-Gard 220V

0480 Pump Cycle Monitor (sensor & wires)
0483 Pump Cycle Monitor (module, sensor & wires)
0485 Pump Cycle Monitor (module, sensor & wires), DIN flange
0504 DIN flange

NOTE: MOST ELASTOMERIC MATERIALS USE COLORED DOTS FOR IDENTIFICATION.

NOTE: Not all models are available with all material options.

Viton® is a registered trademark of DuPont Dow Elastomers.

Halar® is a registered trademark of Solvay.



HOW IT WORKS—PUMP

The Wilden diaphragm pump is an air-operated, positive displacement, self-priming pump. These drawings show flow pattern through the pump upon its initial stroke. It is assumed the pump has no fluid in it prior to its initial stroke.

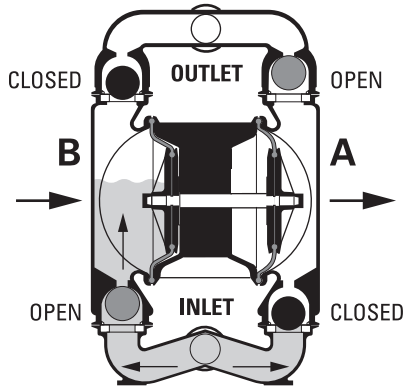

FIGURE 1 The air valve directs pressurized air to the back side of diaphragm A. The compressed air is applied directly to the liquid column separated by elastomeric diaphragms. The diaphragm acts as a separation membrane between the compressed air and liquid, balancing the load and removes mechanical stress from the diaphragm. The compressed air moves the diaphragm away from the center of the pump. The opposite diaphragm is pulled in by the shaft connected to the pressurized diaphragm. Diaphragm B is on its suction stroke; air behind the diaphragm has been forced out to atmosphere through the exhaust port of the pump. The movement of diaphragm B toward the center of the pump creates a vacuum within chamber B. Atmospheric pressure forces fluid into the inlet manifold forcing the inlet valve ball off its seat. Liquid is free to move past the inlet valve ball and fill the liquid chamber (see shaded area).

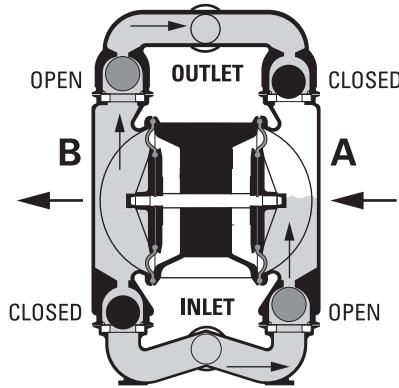

FIGURE 2 When the pressurized diaphragm (diaphragm A), reaches the limit of its discharge stroke, the air valve redirects pressurized air to the back side of diaphragm B. The pressurized air forces diaphragm B away from the center while pulling diaphragm A to the center. Diaphragm B is now on its discharge stroke. Diaphragm B forces the inlet valve ball onto its seat due to the hydraulic forces developed in the liquid chamber and manifold of the pump. These same hydraulic forces lift the discharge valve ball off its seat, forcing fluid to flow through the pump discharge. The movement of diaphragm A toward the center of the pump creates a vacuum within liquid chamber A. Atmospheric pressure forces fluid into the inlet manifold of the pump. The inlet valve ball is forced off its seat allowing the fluid being pumped to fill the liquid chamber.

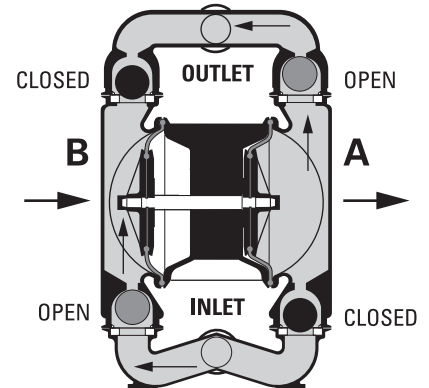
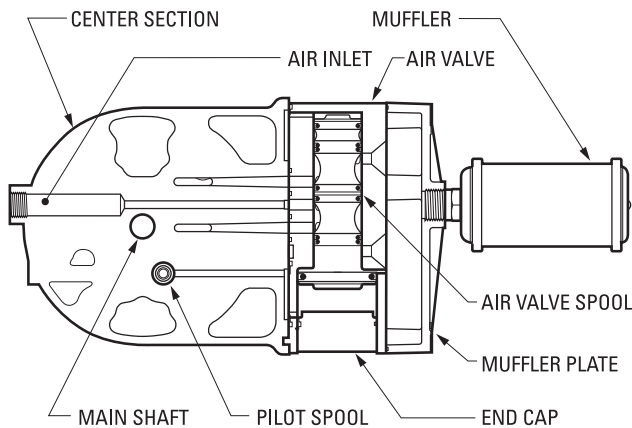

FIGURE 3 At completion of the stroke, the air valve again redirects air to the back side of diaphragm A, which starts diaphragm B on its exhaust stroke. As the pump reaches its original starting point, each diaphragm has gone through one exhaust and one discharge stroke. This constitutes one complete pumping cycle. The pump may take several cycles to completely prime depending on the conditions of the application.



HOW IT WORKS—AIR DISTRIBUTION SYSTEM



The Pro-Flo® patented Air Distribution System incorporates two moving parts: the air valve spool and the pilot spool. The heart of the system is the air valve spool and air valve. This valve design incorporates an unbalanced spool. The smaller end of the spool is pressurized continuously, while the large end is alternately pressurized then exhausted to move the spool. The spool directs pressurized air to one air chamber while exhausting the other. The air causes the main shaft/diaphragm assembly to shift to one side — discharging liquid on that side and pulling liquid in on the other side. When the shaft reaches the end of its stroke, the inner piston actuates the pilot spool, which pressurizes and exhausts the large end of the air valve spool. The repositioning of the air valve spool routes the air to the other air chamber.

DIMENSIONAL DRAWINGS

P800 Aluminum

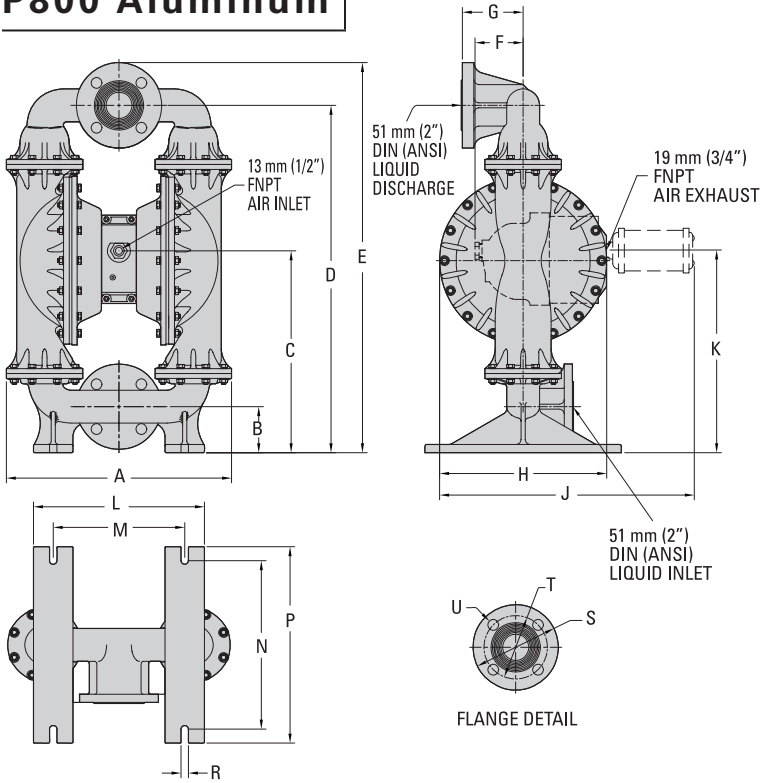

DIMENSIONS

ITEM	METRIC (mm)	STANDARD (inch)
A	439	17.3
B	89	3.5
C	396	15.6
D	676	26.6
E	760	29.9
F	94	3.7
G	117	4.6
H	325	12.8
J	493	19.4
K	396	15.6
L	330	13.0
M	254	10.0
N	325	12.8
P	379	14.9
R	15	0.6
ANSI/DIN COMBO		
S	165 DIA.	6.5 DIA.
T	122 DIA.	4.8 DIA.
U	20 DIA.	0.8 DIA.

P800 Stainless Steel/Alloy C

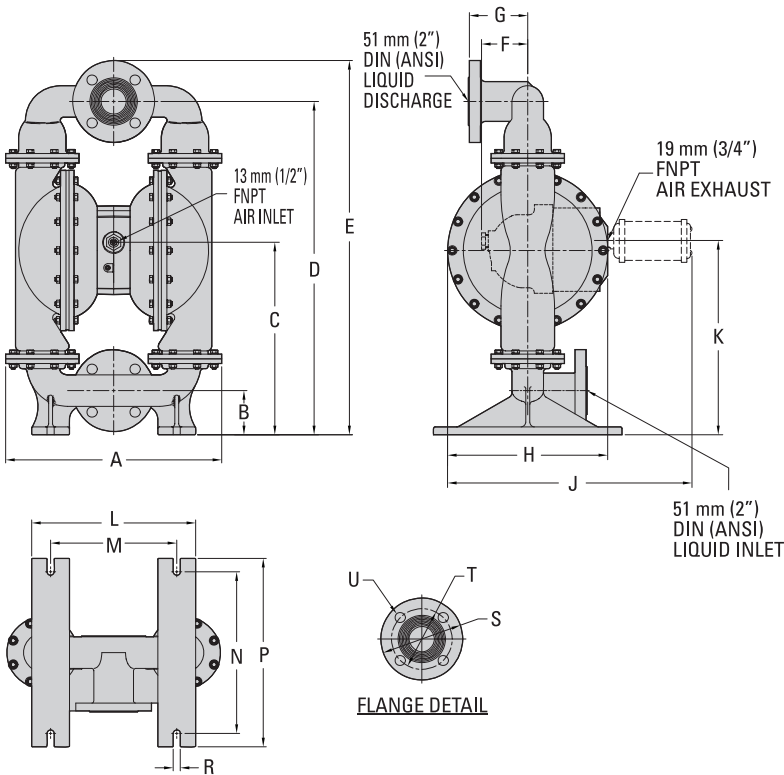

DIMENSIONS

ITEM	METRIC (mm)	STANDARD (inch)
A	434	17.1
B	89	3.5
C	389	15.3
D	678	26.7
E	760	29.9
F	94	3.7
G	117	4.6
H	325	12.8
J	493	19.4
K	391	15.4
L	330	13.0
M	254	10.0
N	325	12.8
P	379	14.9
R	15	0.6
DIN DN50		
S	165 DIA.	6.5 DIA.
T	125 DIA.	4.9 DIA.
U	18 DIA.	0.7 DIA.
ANSI 150#		
S	165 DIA.	6.5 DIA.
T	122 DIA.	4.8 DIA.
U	20 DIA.	0.8 DIA.

PX800 Aluminum

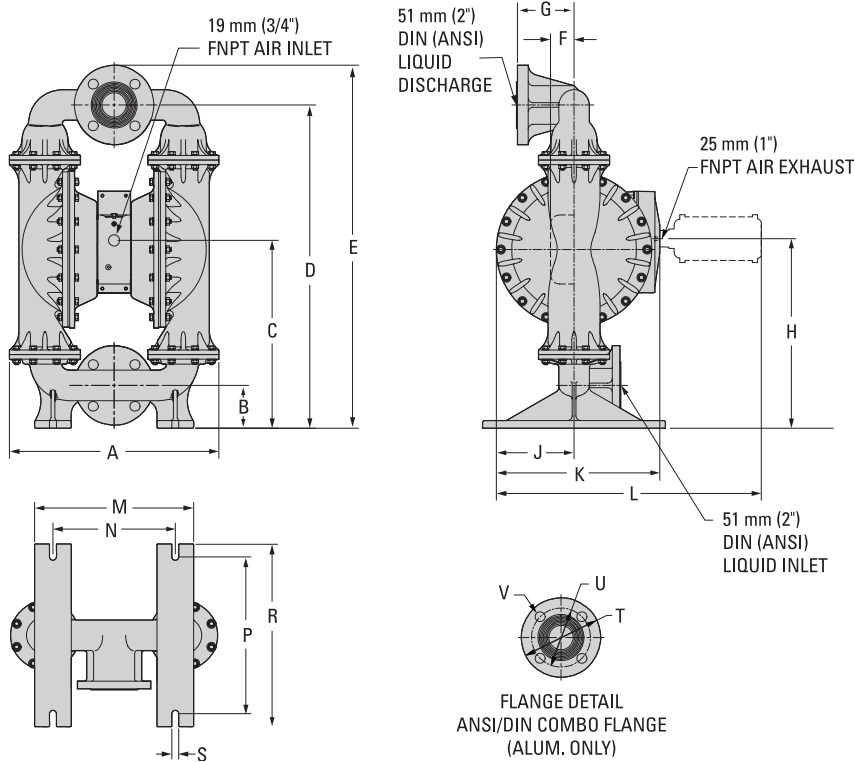

DIMENSIONS

ITEM	METRIC (mm)	STANDARD (inch)
A	439	17.3
B	89	3.5
C	396	15.6
D	676	26.6
E	760	29.9
F	48	1.9
G	117	4.6
H	399	15.7
J	163	6.4
K	340	13.4
L	551	21.7
M	330	13.0
N	254	10.0
P	325	12.8
R	379	14.9
S	15	0.6
ANSI/DIN COMBO		
T	165 DIA.	6.5 DIA.
U	122 DIA.	4.8 DIA.
V	20 DIA.	0.8 DIA.

PX800 Stainless Steel/Alloy C

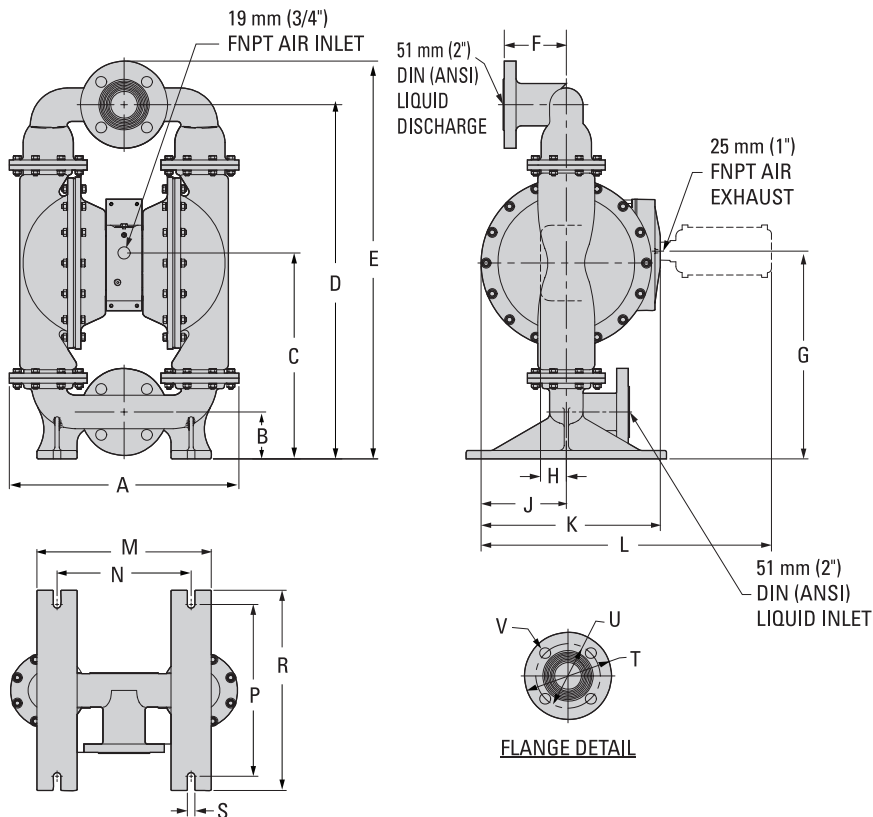

DIMENSIONS

ITEM	METRIC (mm)	STANDARD (inch)
A	434	17.1
B	89	3.5
C	391	15.4
D	678	26.7
E	760	29.9
F	117	4.6
G	394	15.5
H	48	1.9
J	163	6.4
K	340	13.4
L	551	21.7
M	330	13.0
N	254	10.0
P	325	12.8
R	378	14.9
S	15	0.6
DIN DN50		
T	165 DIA.	6.5 DIA.
U	125 DIA.	4.9 DIA.
V	18 DIA.	0.7 DIA.
ANSI 150#		
T	165 DIA.	6.5 DIA.
U	122 DIA.	4.8 DIA.
V	20 DIA.	0.8 DIA.

**P800 METAL
ULTRA-FLEX™-FITTED**

Height759 mm (29.9")
 Width 439 mm (17.3")
 Depth 325 mm (12.8")
 Ship WeightAluminum 34 kg (75 lb)
 316 Stainless Steel 100 kg (220 lb)
 Alloy C 103 kg (228 lb)
 Air Inlet..... 13 mm (1/2")
 Inlet..... 51 mm (2")
 Outlet..... 51 mm (2")
 Suction Lift4.9 m Dry (16')
 8.8 m Wet (29')
 Disp. Per Stroke.....2.12 L (0.56 gal)¹
 Max. Flow Rate.....526 lpm (139 gpm)
 Max. Size Solids.....6.4 mm (1/4")

¹Displacement per stroke was calculated at 4.8 bar (70 psig) air inlet pressure against a 2.1 bar (30 psig) head pressure.

Example: To pump 201 lpm (53 gpm) against a discharge pressure head of 2.1 bar (30 psig) requires 4.1 bar (60 psig) and 60 Nm³/h (35 scfm) air consumption.

Caution: Do not exceed 8.6 bar (125 psig) air supply pressure.

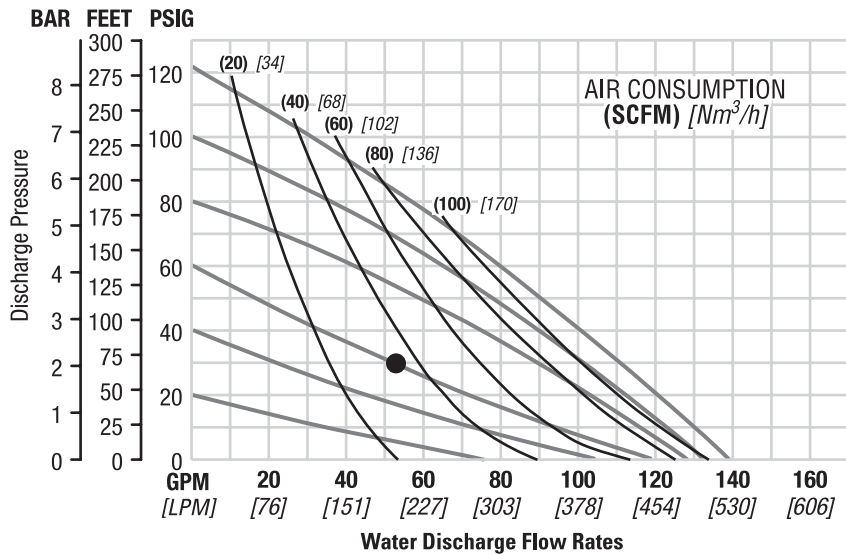

Flow rates indicated on chart were determined by pumping water.

For optimum life and performance, pumps should be specified so that daily operation parameters will fall in the center of the pump's performance curve.

**P800 METAL
SUCTION-LIFT CAPABILITY**

Suction-lift curves are calibrated for pumps operating at 305 m (1,000') above sea level. This chart is meant to be a guide only. There are many variables that can affect your pump's operating characteristics.

The number of intake and discharge elbows, viscosity of pumping fluid, elevation (atmospheric pressure) and pipe friction loss all affect the amount of suction lift your pump will attain.

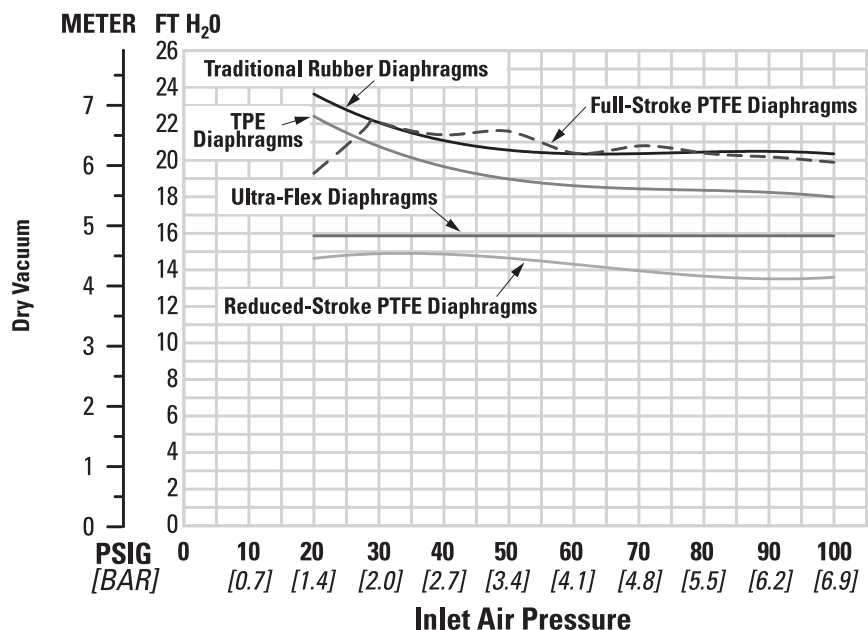

PX800

M E T A L

WILDEN
A DOVER COMPANY

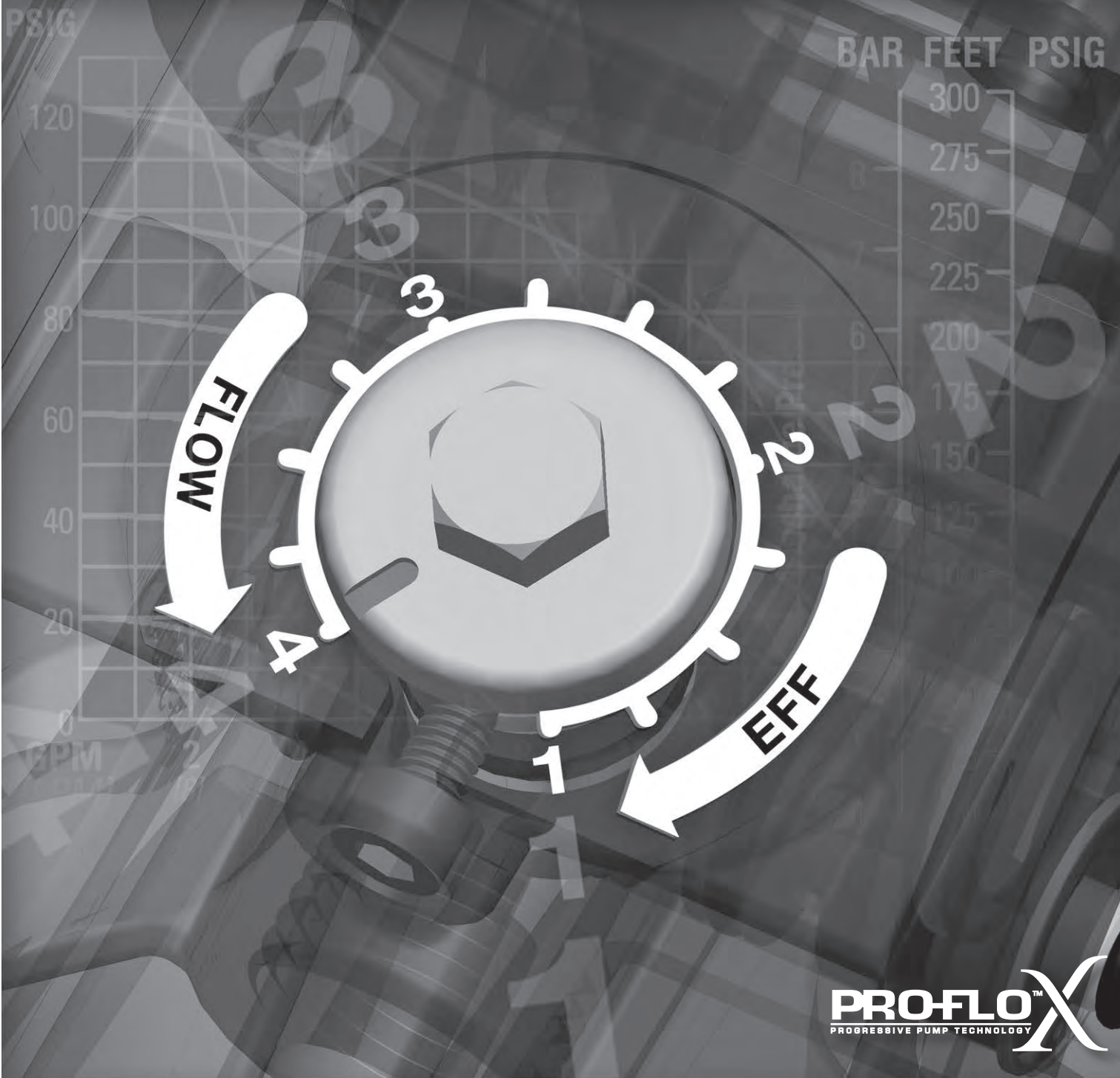

PX800 PERFORMANCE



Pro-Flo X™ Operating Principle

The Pro-Flo X™ air distribution system with the revolutionary Efficiency Management System (EMS) offers flexibility never before seen in the world of AODD pumps. The EMS is simple and easy to use. With the turn of an integrated control dial, the

operator can select the optimal balance of flow and efficiency that best meets the application needs. Pro-Flo X™ provides higher performance, lower operational costs and flexibility that exceeds previous industry standards.



<p>Turning the dial changes the relationship between air inlet and exhaust porting.</p>	<p>Each dial setting represents an entirely different flow curve.</p>	<p>Pro-Flo X™ pumps are shipped from the factory on setting 4, which is the highest flow rate setting possible.</p>	<p>Moving the dial from setting 4 causes a decrease in flow and an even greater decrease in air consumption.</p>	<p>When the air consumption decreases more than the flow rate, efficiency is improved and operating costs are reduced.</p>

Example 1

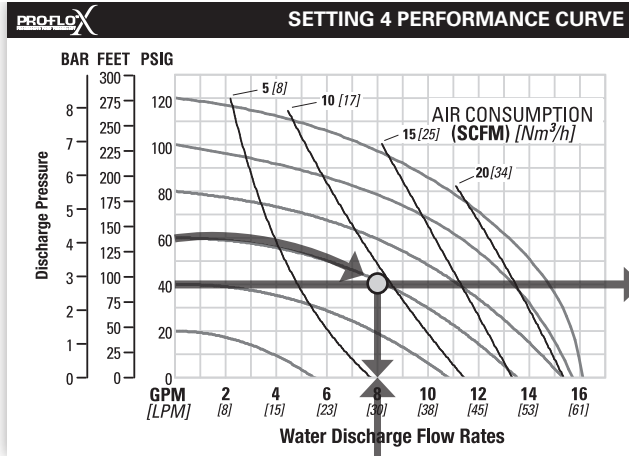

Figure 1

Example data point = **8.2** GPM

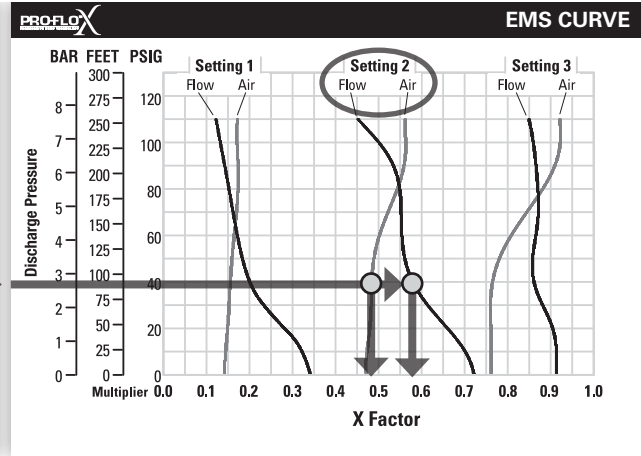

Figure 2

Example data point = **0.58** flow multiplier
0.48 air multiplier

This is an example showing how to determine flow rate and air consumption for your Pro-Flo X™ pump using the Efficiency Management System (EMS) curve and the performance curve. For this example we will be using 4.1 bar (60 psig) inlet air pressure and 2.8 bar (40 psig) discharge pressure and EMS setting 2.

Step 1: Identifying performance at setting 4. Locate the curve that represents the flow rate of the pump with 4.1 bar (60 psig) air inlet pressure. Mark the point where this curve crosses the horizontal line representing 2.8 bar (40 psig) discharge pressure (Figure 1). After locating your performance point on the flow curve, draw a vertical line downward until reaching the bottom scale on the chart. Identify the flow rate (in this case, 8.2 gpm). Observe location of performance point relative to air consumption curves and approximate air consumption value (in this case, 9.8 scfm).

Step 2: Determining flow and air X Factors. Locate your discharge pressure (40 psig) on the vertical axis of the EMS curve (Figure 2). Follow along the 2.8 bar (40 psig) horizontal line until intersecting both flow and air curves for your desired EMS setting (in this case, setting 2). Mark the points where the EMS curves intersect the horizontal discharge pressure line. After locating your EMS points on the EMS

curve, draw vertical lines downward until reaching the bottom scale on the chart. This identifies the flow X Factor (in this case, 0.58) and air X Factor (in this case, 0.48).

Step 3: Calculating performance for specific EMS setting. Multiply the flow rate (8.2 gpm) obtained in Step 1 by the flow X Factor multiplier (0.58) in Step 2 to determine the flow rate at EMS setting 2. Multiply the air consumption (9.8 scfm) obtained in Step 1 by the air X Factor multiplier (0.48) in Step 2 to determine the air consumption at EMS setting 2 (Figure 3).

8.2 gpm	(flow rate for setting 4)
.58	(flow X Factor setting 2)
4.8 gpm	(flow rate for setting 2)
9.8 scfm	(air consumption for setting 4)
.48	(air X Factor setting 2)
4.7 scfm	(air consumption for setting 2)

Figure 3

The flow rate and air consumption at setting 2 are found to be 18.2 lpm (4.8 gpm) and 7.9 Nm³/h (4.7 scfm) respectively.

Example 2.1

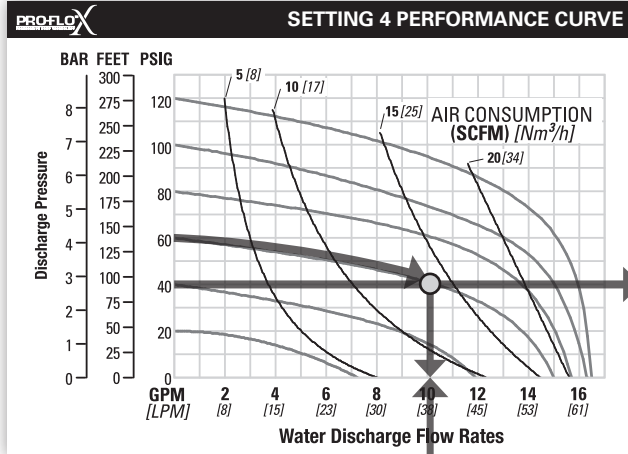

Figure 4

Example data point = **10.2** gpm

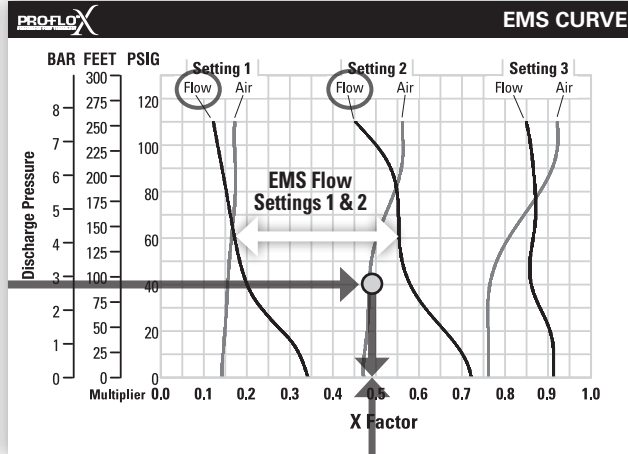

Figure 5

0.49 flow multiplier

This is an example showing how to determine the inlet air pressure and the EMS setting for your Pro-Flo X™ pump to optimize the pump for a specific application. For this example we will be using an application requirement of 18.9 lpm (5 gpm) flow rate against 2.8 bar (40 psig) discharge pressure. This example will illustrate how to calculate the air consumption that could be expected at this operational point.

DETERMINE EMS SETTING

Step 1: Establish inlet air pressure. Higher air pressures will typically allow the pump to run more efficiently, however, available plant air pressure can vary greatly. If an operating pressure of 6.9 bar (100 psig) is chosen when plant air frequently dips to 6.2 bar (90 psig) pump performance will vary. Choose an operating pressure that is within your compressed air system's capabilities. For this example we will choose 4.1 bar (60 psig).

Step 2: Determine performance point at setting 4. For this example an inlet air pressure of 4.1 bar (60 psig) inlet air pressure has been chosen. Locate the curve that represents the performance of the pump with 4.1 bar (60 psig) inlet air pressure. Mark the point where this curve crosses the horizontal line representing 2.8 bar (40 psig) discharge pressure. After locating this point on the flow curve, draw a vertical line downward until reaching the bottom scale on the chart and identify the flow rate.

In our example it is 38.6 lpm (10.2 gpm). This is the setting 4 flow rate. Observe the location of the performance point relative to air consumption curves and approximate air consumption value. In our example setting 4 air consumption is 24 Nm³/h (14 scfm). (See Figure 4.)

Step 3: Determine flow X Factor. Divide the required flow rate 18.9 lpm (5 gpm) by the setting 4 flow rate 38.6 lpm (10.2 gpm) to determine the flow X Factor for the application.

$$5 \text{ gpm} / 10.2 \text{ gpm} = 0.49 \text{ (flow X Factor)}$$

Step 4: Determine EMS setting from the flow X Factor. Plot the point representing the flow X Factor (0.49) and the application discharge pressure 2.8 bar (40 psig) on the EMS curve. This is done by following the horizontal 2.8 bar (40 psig) discharge pressure line until it crosses the vertical 0.49 X Factor line. Typically, this point lies between two flow EMS setting curves (in this case, the point lies between the flow curves for EMS setting 1 and 2). Observe the location of the point relative to the two curves it lies between and approximate the EMS setting (Figure 5). For more precise results you can mathematically interpolate between the two curves to determine the optimal EMS setting.

For this example the EMS setting is 1.8.

Example 2.2

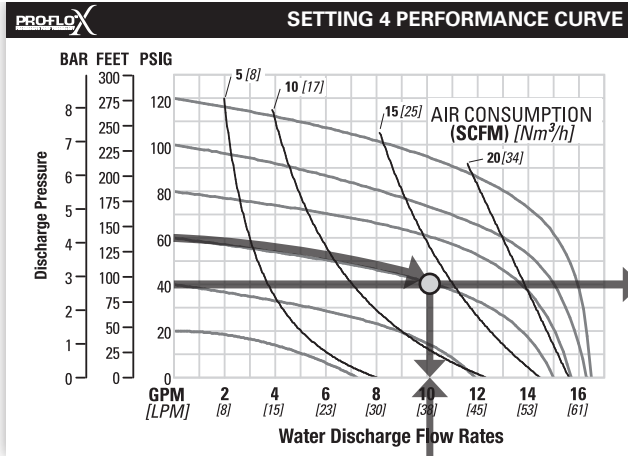

Figure 6

Example data point = **10.2** gpm

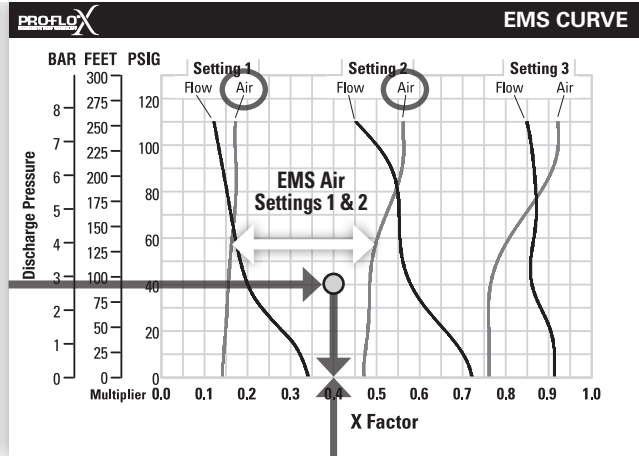

Figure 7

Example data point = **0.40** air multiplier

Determine air consumption at a specific EMS setting.

Step 1: Determine air X Factor. In order to determine the air X Factor, identify the two air EMS setting curves closest to the EMS setting established in example 2.1 (in this case, the point lies between the air curves for EMS setting 1 and 2). The point representing your EMS setting (1.8) must be approximated and plotted on the EMS curve along the horizontal line representing your discharge pressure (in this case, 40 psig). This air point is different than the flow point plotted in example 2.1. After estimating (or interpolating) this point on the curve, draw a vertical line downward until reaching the bottom scale on the chart and identify the air X Factor (Figure 7).

For this example the air X Factor is **0.40**.

Step 2: Determine air consumption. Multiply your setting 4 air consumption (14 scfm) value by the air X Factor obtained above (0.40) to determine your actual air consumption.

$$14 \text{ scfm} \times 0.40 = 5.6 \text{ SCFM}$$

In summary, for an application requiring 18.9 lpm (5 gpm) against 2.8 bar (40 psig) discharge pressure, the pump inlet air pressure should be set to 4.1 bar (60 psig) and the EMS dial should be set to 1.8. The pump would then consume 9.5 Nm³/h (5.6 scfm) of compressed air.

PX800 METAL RUBBER-FITTED



PERFORMANCE



SETTING 4 PERFORMANCE CURVE

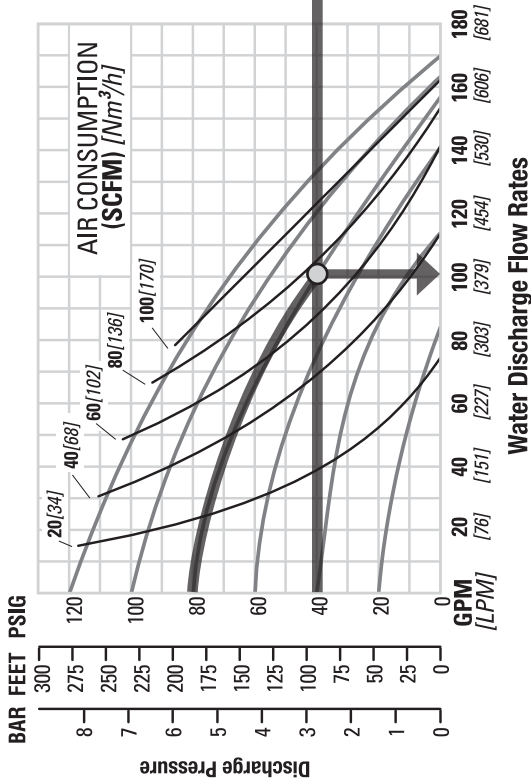

EMS CURVE

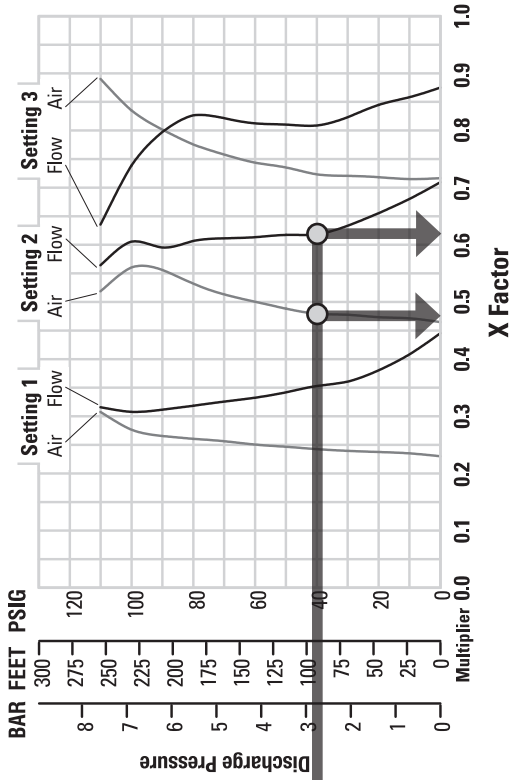

TECHNICAL DATA

Height	760 mm (29.9")
Width	439 mm (17.3")
Depth	493 mm (19.4")
Ship Weight	Aluminum 35 kg (78 lb)
	316 Stainless Steel 73 kg (161 lb)
Air Inlet	Cast Iron 49 kg (109 lb)
	Alloy C 54 kg (119 lb)
Inlet	19 mm (3/4")
Outlet	51 mm (2")
Suction Lift	51 mm (2")
	6.4 m Dry (21')
	8.6 m Wet (28.4')
Disp. Per Stroke	2.7 L (0.72 gal)
Max. Flow Rate	.642 lpm (170 gpm)
Max. Size Solids	6.4 mm (1/4")

¹Displacement per stroke was calculated at 4.8 bar (70 psig) air inlet pressure against a 2.1 bar (30 psig) head pressure.

The Efficiency Management System (EMS) can be used to optimize the performance of your Wilden pump for specific applications. The pump is delivered with the EMS adjusted to setting 4, which allows maximum flow.

The EMS curve allows the pump user to determine flow and air consumption at each EMS setting. For any EMS setting and discharge pressure, the X factor is used as a multiplier with the original values from the setting 4 performance curve to calculate the actual flow and air consumption values for that specific EMS setting. NOTE: You can interpolate between the setting curves for operation at intermediate EMS settings.

EXAMPLE

A PX800 metal, rubber-fitted pump operating at EMS setting 4 achieved a flow rate of 379 lpm (100 gpm) using 127 Nm³/h (75 scfm) of air when run at 5.5 bar (80 psig) air inlet pressure and 2.8 bar (40 psig) discharge pressure (see dot on performance curve).

The end user did not require that much flow and wanted to reduce air consumption at his facility. He determined that EMS setting 2 would meet his needs. At 2.8 bar (40 psig) discharge pressure and EMS setting 2, the flow X factor is 0.63 and the air X factor is 0.47 (see dots on EMS curve).

Multiplying the original setting 4 values by the X factors provides the setting 2 flow rate of 238 lpm (63 gpm) and an air consumption of 60 Nm³/h (35 scfm). The flow rate was reduced by 37% while the air consumption was reduced by 53%, thus providing increased efficiency.

For a detailed example for how to set your EMS, see beginning of performance curve section.

Caution: Do not exceed 8.6 bar (125 psig) air supply pressure.

PX800 METAL TPE-FITTED

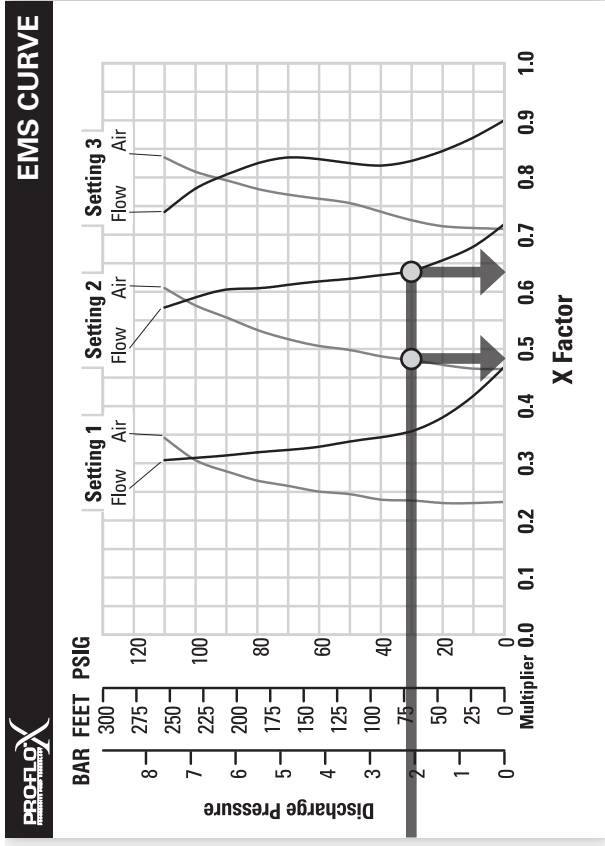
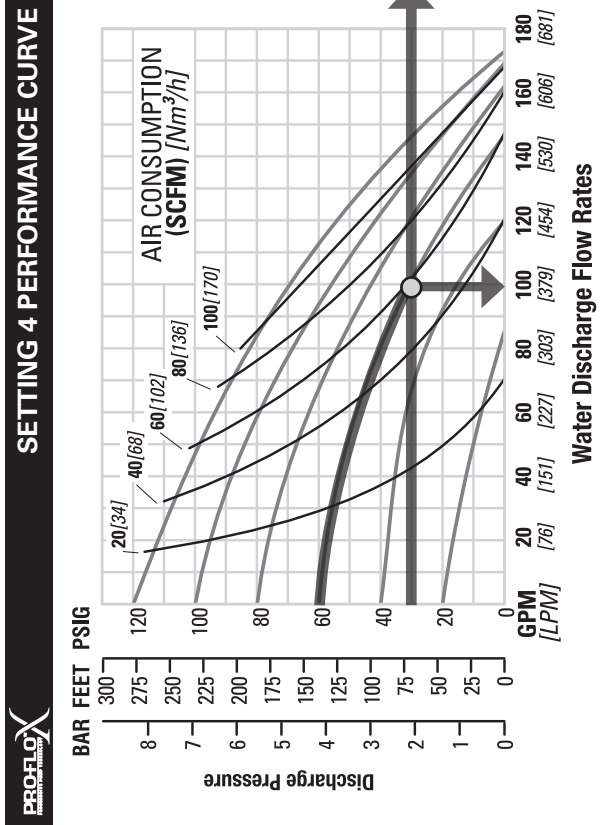

TECHNICAL DATA

Height	760 mm (29.9")
Width	439 mm (17.3")
Depth	493 mm (19.4")
Ship Weight	Aluminum 35 kg (78 lb) 316 Stainless Steel 73 kg (161 lb)
Air Inlet	Cast Iron 49 kg (109 lb) Alloy C 54 kg (119 lb)
Inlet	19 mm (3/4")
Outlet	51 mm (2")
Suction Lift	5.9 m Dry (19.3') 8.6 m Wet (28.4')
Disp. Per Stroke	287 L (0.74 gal)
Max. Flow Rate	654 lpm (173 gpm)
Max. Size Solids	6.4 mm (1/4")

¹Displacement per stroke was calculated at 4.8 bar (70 psig) air inlet pressure against a 2.1 bar (30 psig) head pressure.

The Efficiency Management System (EMS) can be used to optimize the performance of your Wilden pump for specific applications. The pump is delivered with the EMS adjusted to setting 4, which allows maximum flow.

The EMS curve allows the pump user to determine flow and air consumption at each EMS setting. For any EMS setting and discharge pressure, the X factor is used as a multiplier with the original values from the setting 4 performance curve to calculate the actual flow and air consumption values for that specific EMS setting. NOTE: You can interpolate between the setting curves for operation at intermediate EMS settings.

EXAMPLE

A PX800 metal, TPE-fitted pump operating at EMS setting 4 achieved a flow rate of 371 lpm (98 gpm) using 99 Nm³/h (58 scfm) of air when run at 4.1 bar (60 psig) air inlet pressure and 2.1 bar (30 psig) discharge pressure (see dot on performance curve).

The end user did not require that much flow and wanted to reduce air consumption at his facility. He determined that EMS setting 2 would meet his needs. At 2.1 bar (30 psig) discharge pressure and EMS setting 2, the flow X factor is 0.63 and the air X factor is 0.48 (see dots on EMS curve).

Multiplying the original setting 4 values by the X factors provides the setting 2 flow rate of 234 lpm (63 gpm) and an air consumption of 47 Nm³/h (28 scfm). The flow rate was reduced by 37% while the air consumption was reduced by 52%, thus providing increased efficiency.

For a detailed example for how to set your EMS, see beginning of performance curve section.

Caution: Do not exceed 8.6 bar (125 psig) air supply pressure.

PX800 METAL REDUCED-STROKE PTFE-FITTED



PERFORMANCE



SETTING 4 PERFORMANCE CURVE

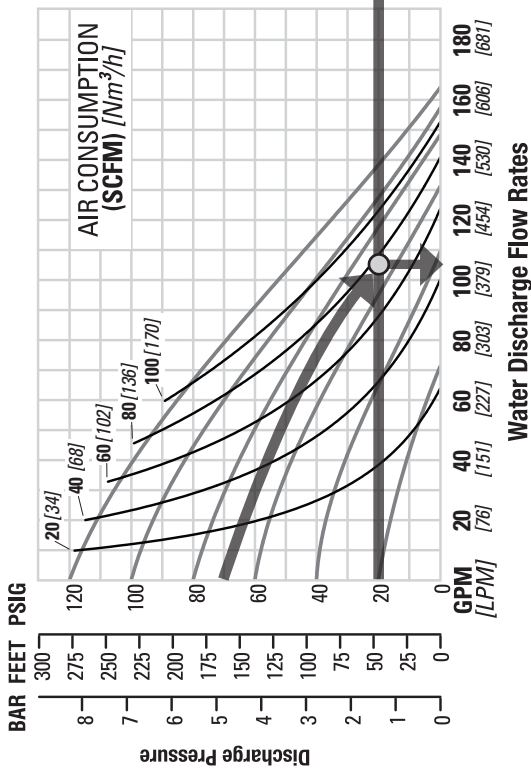

EMS CURVE

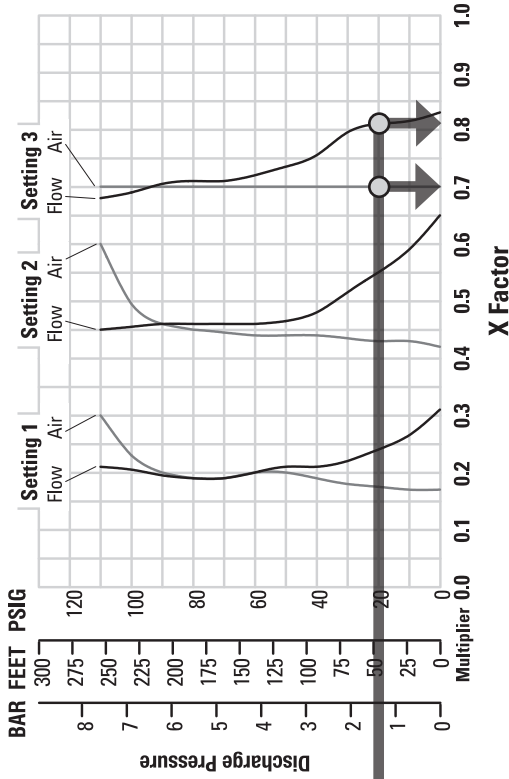

TECHNICAL DATA

Height668 mm (26.3")
Width404 mm (15.9")
Depth340 mm (13.4")
Ship WeightAluminum 35 kg (78 lb)
316 Stainless Steel 73 kg (161 lb)
Cast Iron 49 kg (109 lb)
Alloy C 54 kg (119 lb)
Air Inlet19 mm (3/4")
Inlet51 mm (2")
Outlet51 mm (2")
Suction Lift4.5 m Dry (14.8')
8.7 m Wet (28.4')
Disp. Per Stroke1.9 L (0.51 gal) ¹
Max. Flow Rate617 lpm (163 gpm)
Max. Size Solids6.4 mm (1/4")

¹Displacement per stroke was calculated at 4.8 bar (70 psig) air inlet pressure against a 2.1 bar (30 psig) head pressure.

The Efficiency Management System (EMS) can be used to optimize the performance of your Wilden pump for specific applications. The pump is delivered with the EMS adjusted to setting 4, which allows maximum flow.

The EMS curve allows the pump user to determine flow and air consumption at each EMS setting. For any EMS setting and discharge pressure, the X factor is used as a multiplier with the original values from the setting 4 performance curve to calculate the actual flow and air consumption values for that specific EMS setting. NOTE: You can interpolate between the setting curves for operation at intermediate EMS settings.

EXAMPLE

A PX800 metal, reduced-stroke PTFE-fitted pump operating at EMS setting 4 achieved a flow rate of 401 lpm (106 gpm) using 133 Nm³/h (78 scfm) of air when run at 4.8 bar (70 psig) air inlet pressure and 1.4 bar (20 psig) discharge pressure (see dot on performance curve).

The end user did not require that much flow and wanted to reduce air consumption at his facility. He determined that EMS setting 3 would meet his needs. At 1.4 bar (20 psig) discharge pressure and EMS setting 3, the flow X factor is 0.82 and the air X factor is 0.70 (see dots on EMS curve).

Multiplying the original setting 4 values by the X factors provides the setting 3 flow rate of 329 lpm (87 gpm) and an air consumption of 93 Nm³/h (55 scfm). The flow rate was reduced by 18% while the air consumption was reduced by 30%, thus providing increased efficiency.

For a detailed example for how to set your EMS, see beginning of performance curve section.

Caution: Do not exceed 8.6 bar (125 psig) air supply pressure.

PX800 METAL FULL-STROKE PTFE-FITTED

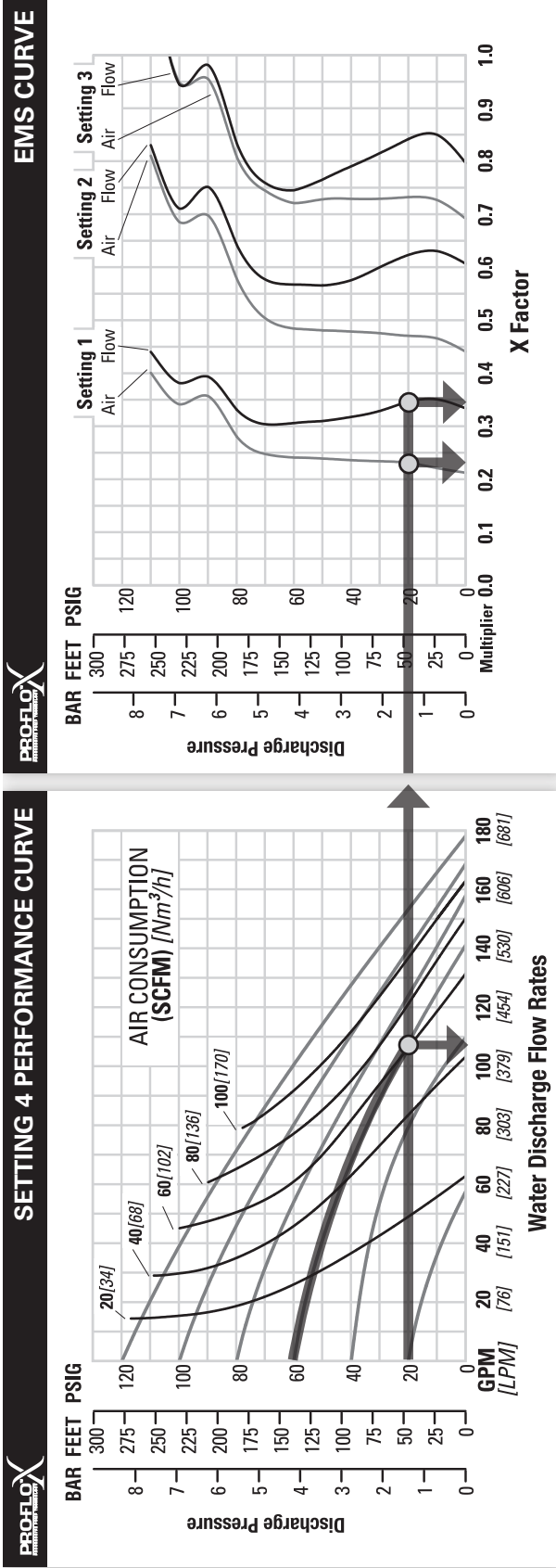

TECHNICAL DATA

Height668 mm (26.3")
Width404 mm (15.9")
Depth340 mm (13.4")
Ship WeightAluminum 35 kg (78 lb)316 Stainless 73 kg (161 lb)
Air InletCast Iron 49 Kg (109 lb)Alloy C 54 Kg (119 lb)
Inlet19 mm (3/4")
Outlet51 mm (2")
Suction Lift51 mm (2")6.1 m Dry (19.9')8.6 m Wet (28.4')
Disp. Per Stroke2.6 L (0.68 gal) ¹
Max. Flow Rate674 lpm (178 gpm)
Max. Size Solids64 mm (1/4")

¹Displacement per stroke was calculated at 4.8 bar (70 psig) air inlet pressure against a 2.1 bar (30 psig) head pressure.

The Efficiency Management System (EMS) can be used to optimize the performance of your Wilden pump for specific applications. The pump is delivered with the EMS adjusted to setting 4, which allows maximum flow.

The EMS curve allows the pump user to determine flow and air consumption at each EMS setting. For any EMS setting and discharge pressure, the X factor is used as a multiplier with the original values from the setting 4 performance curve to calculate the actual flow and air consumption values for that specific EMS setting. NOTE: You can interpolate between the setting curves for operation at intermediate EMS settings.

EXAMPLE

A PX800 metal, full-stroke PTFE-fitted pump operating at EMS setting 4 achieved a flow rate of 405 lpm (107 gpm) using 105 Nm³/h (62 scfm) of air when run at 4.1 bar (60 psig) air inlet pressure and 1.4 bar (20 psig) discharge pressure (see dot on performance curve).

The end user did not require that much flow and wanted to reduce air consumption at his facility. He determined that EMS setting 1 would meet his needs. At 1.4 bar (20 psig) discharge pressure and EMS setting 1, the flow X factor is 0.34, and the air X factor is 0.23 (see dots on EMS curve).

Multiplying the original setting 4 values by the X factors provides the setting 1 flow rate of 138 lpm (36 gpm) and an air consumption of 24 Nm³/h (14 scfm). The flow rate was reduced by 66% while the air consumption was reduced by 77%, thus providing increased efficiency.

For a detailed example for how to set your EMS, see beginning of performance curve section.

Caution: Do not exceed 8.6 bar (125 psig) air supply pressure.

PX800 METAL ULTRA-FLEX™ FITTED



PERFORMANCE



SETTING 4 PERFORMANCE CURVE

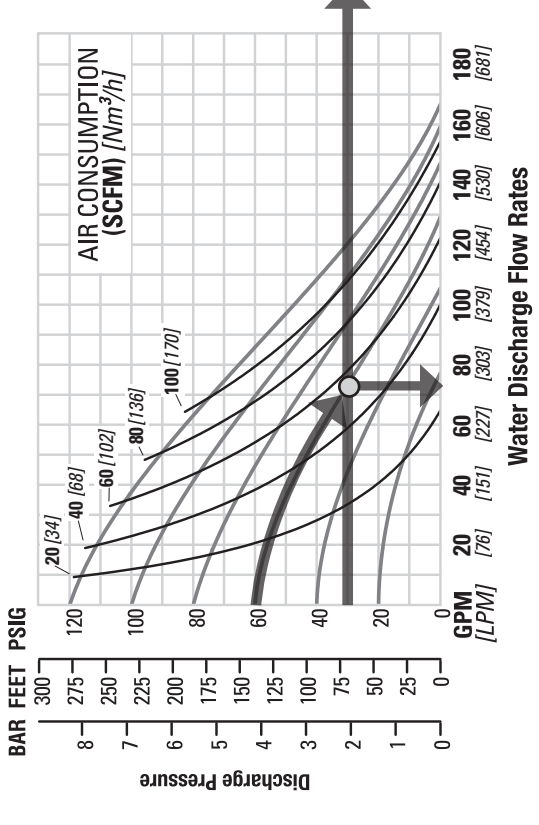

EMS CURVE

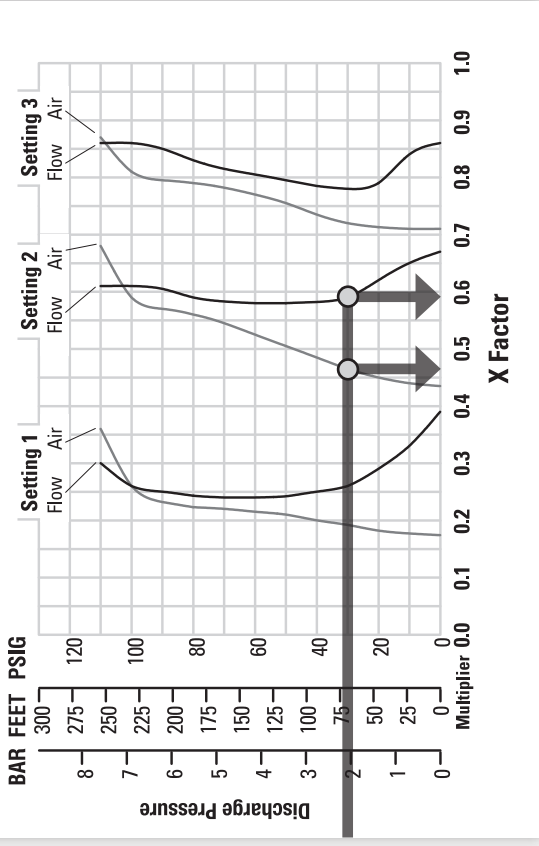

TECHNICAL DATA

Height	668 mm (26.3")
Width	404 mm (15.9")
Depth	340 mm (13.4")
Ship Weight	Aluminum 35 kg (78 lb) 316 Stainless Steel 73 kg (161 lb) Cast Iron 49 kg (109 lb) Alloy C 54 kg (119 lb)
Air Inlet	19 mm (3/4")
Inlet	51 mm (2")
Outlet	51 mm (2")
Suction Lift	6.1 m Dry (19.9') 9.2 m Wet (30.1')
Disp. Per Stroke	2.1 L (0.56 gal)
Max. Flow Rate	.632 lpm (167 gpm)
Max. Size Solids	6.4 mm (1/4")

¹Displacement per stroke was calculated at 4.8 bar (70 psig) air inlet pressure against a 2.1 bar (30 psig) head pressure.

EXAMPLE

A PX800 metal, Ultra-Flex™-fitted pump operating at EMS setting 4 achieved a flow rate of 276 lpm (73 gpm) using 93 Nm³/h (55 scfm) of air when run at 4.1 bar (60 psig) air inlet pressure and 2.1 bar (30 psig) discharge pressure (see dot on performance curve).

The end user did not require that much flow and wanted to reduce air consumption at his facility. He determined that EMS setting 2 would meet his needs. At 2.1 bar (30 psig) discharge pressure and EMS setting 2, the flow X factor is 0.59 and the air X factor is 0.46 (see dots on EMS curve).

Multiplying the original setting 4 values by the X factors provides the setting 2 flow rate of 163 lpm (43 gpm) and an air consumption of 43 Nm³/h (25 scfm). The flow rate was reduced by 41% while the air consumption was reduced by 54%, thus providing increased efficiency.

For a detailed example for how to set your EMS, see beginning of performance curve section.

Caution: Do not exceed 8.6 bar (125 psig) air supply pressure.

The Efficiency Management System (EMS) can be used to optimize the performance of your Wilden pump for specific applications. The pump is delivered with the EMS adjusted to setting 4, which allows maximum flow.

The EMS curve allows the pump user to determine flow and air consumption at each EMS setting. For any EMS setting and discharge pressure, the X factor is used as a multiplier with the original values from the setting 4 performance curve to calculate the actual flow and air consumption values for that specific EMS setting. NOTE: You can interpolate between the setting curves for operation at intermediate EMS settings.

SUCTION-LIFT CURVES

**PX800 METAL
SUCTION-LIFT CAPABILITY**

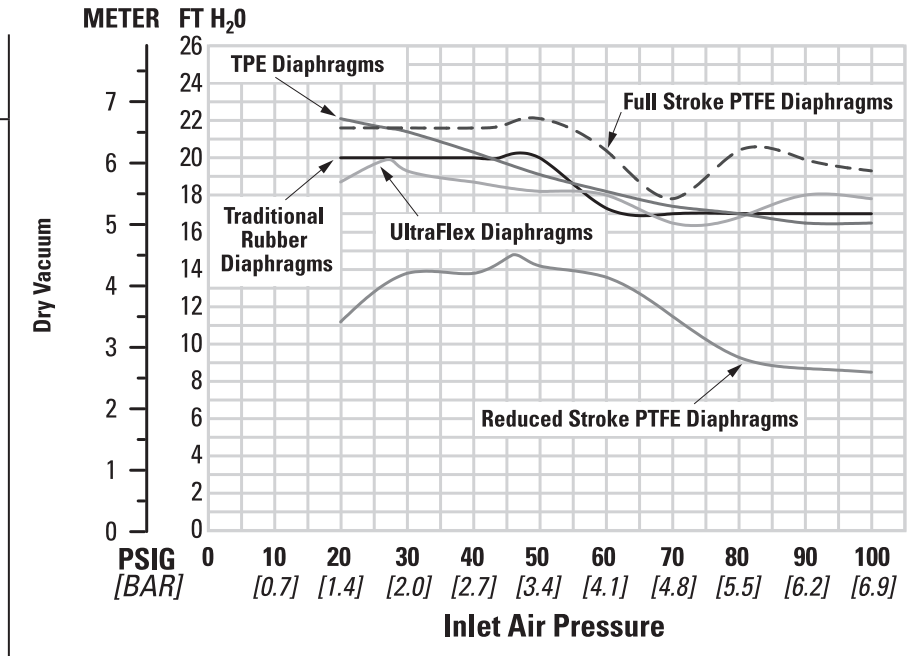

Suction-lift curves are calibrated for pumps operating at 305 m (1,000') above sea level. This chart is meant to be a guide only. There are many variables that can affect your pump's operating characteristics. The

number of intake and discharge elbows, viscosity of pumping fluid, elevation (atmospheric pressure) and pipe friction loss all affect the amount of suction lift your pump will attain.

SUGGESTED INSTALLATION

Wilden pumps are designed to meet the performance requirements of even the most demanding pumping applications. They have been designed and manufactured to the highest standards and are available in a variety of liquid path materials to meet your chemical resistance needs. Refer to the performance section of this manual for an in-depth analysis of the performance characteristics of your pump. Wilden offers the widest variety of elastomer options in the industry to satisfy temperature, chemical compatibility, abrasion resistance and flex concerns.

The suction pipe size should be at least the equivalent or larger than the diameter size of the suction inlet on your Wilden pump. The suction hose must be non-collapsible, reinforced type as these pumps are capable of pulling a high vacuum. Discharge piping should also be the equivalent or larger than the diameter of the pump discharge which will help reduce friction losses. It is critical that all fittings and connections are airtight or a reduction or loss of pump suction capability will result.

INSTALLATION: Months of careful planning, study and selection efforts can result in unsatisfactory pump performance if installation details are left to chance.

Premature failure and long-term dissatisfaction can be avoided if reasonable care is exercised throughout the installation process.

LOCATION: Noise, safety and other logistical factors usually dictate where equipment will be situated on the production floor. Multiple installations with conflicting requirements can result in congestion of utility areas, leaving few choices for additional pumps.

Within the framework of these and other existing conditions, every pump should be located in such a way that the following key factors are balanced against each other to maximum advantage.

ACCESS: First of all, the location should be accessible. If it's easy to reach the pump, maintenance personnel will have an easier time carrying out routine inspections and adjustments. Should major repairs become necessary, ease of access can play a key role in speeding the repair process and reducing total downtime.

AIR SUPPLY: Every pump location should have an air line large enough to supply the volume of air necessary to achieve the desired pumping rate. Use air pressure up to a maximum of 8.6 bar (125 psig) depending on pumping requirements.

For best results, the pumps should use a 5 μ (micron) air filter, needle valve and regulator. The use of an air filter before the pump will ensure that the majority of any pipeline contaminants will be eliminated.

SOLENOID OPERATION: When operation is controlled by a solenoid valve in the air line, three-way valves should be used. This valve allows trapped air between the valve and the pump to bleed off which improves pump performance. Pumping volume can be estimated by counting the number of strokes per minute and then multiplying the figure by the displacement per stroke.

MUFFLER: Sound levels are reduced below OSHA specifications using the standard Wilden muffler. Other mufflers can be used to further reduce sound levels, but they usually reduce pump performance.

ELEVATION: Selecting a site that is well within the pump's dynamic lift capability will assure that loss-of-prime issues will be eliminated. In addition, pump efficiency can be adversely affected if proper attention is not given to site location.

PIPING: Final determination of the pump site should not be made until the piping challenges of each possible location have been evaluated. The impact of current and future installations should be considered ahead of time to make sure that inadvertent restrictions are not created for any remaining sites.

The best choice possible will be a site involving the shortest and straightest hook-up of suction and discharge piping. Unnecessary elbows, bends and fittings should be avoided. Pipe sizes should be selected to keep friction losses within practical limits. All piping should be supported independently of the pump. In addition, the piping should be aligned to avoid placing stress on the pump fittings.

Flexible hose can be installed to aid in absorbing the forces created by the natural reciprocating action of the pump. If the pump is to be bolted down to a solid location, a mounting pad placed between the pump and the foundation will assist in minimizing pump vibration. Flexible connections between the pump and rigid piping will also assist in minimizing pump vibration. If quick-closing valves are installed at any point in the discharge system, or if pulsation within a system becomes a problem, a surge suppressor (SD Equalizer®) should be installed to protect the pump, piping and gauges from surges and water hammer.

If the pump is to be used in a self-priming application, make sure that all connections are airtight and that the suction lift is within the model's ability. **NOTE:** Materials of construction and elastomer material have an effect on suction-lift parameters. Please refer to the performance section for specifics.

When pumps are installed in applications involving flooded suction or suction head pressures, a gate valve should be installed in the suction line to permit closing of the line for pump service.

Pumps in service with a positive suction head are most efficient when inlet pressure is limited to 0.5–0.7 bar (7–10 psig). Premature diaphragm failure may occur if positive suction is 0.7 bar (10 psig) and higher.

SUBMERSIBLE APPLICATIONS: Pro-FloX™ pumps can be used for submersible applications, when using the Pro-Flo X™ single-point exhaust option. Turbo-Flo™ pumps are also available in a single-point exhaust (submersible) configuration.

NOTE: Pro-Flo® and Accu-Flo™ pumps do not have a single-point exhaust option and are not submersible.

ALL WILDEN PUMPS ARE CAPABLE OF PASSING SOLIDS. A STRAINER SHOULD BE USED ON THE PUMP INTAKE TO ENSURE THAT THE PUMP'S RATED SOLIDS CAPACITY IS NOT EXCEEDED.

CAUTION: DO NOT EXCEED 8.6 BAR (125 PSIG) AIR SUPPLY PRESSURE.

This illustration is a generic representation of an air-operated double-diaphragm pump.

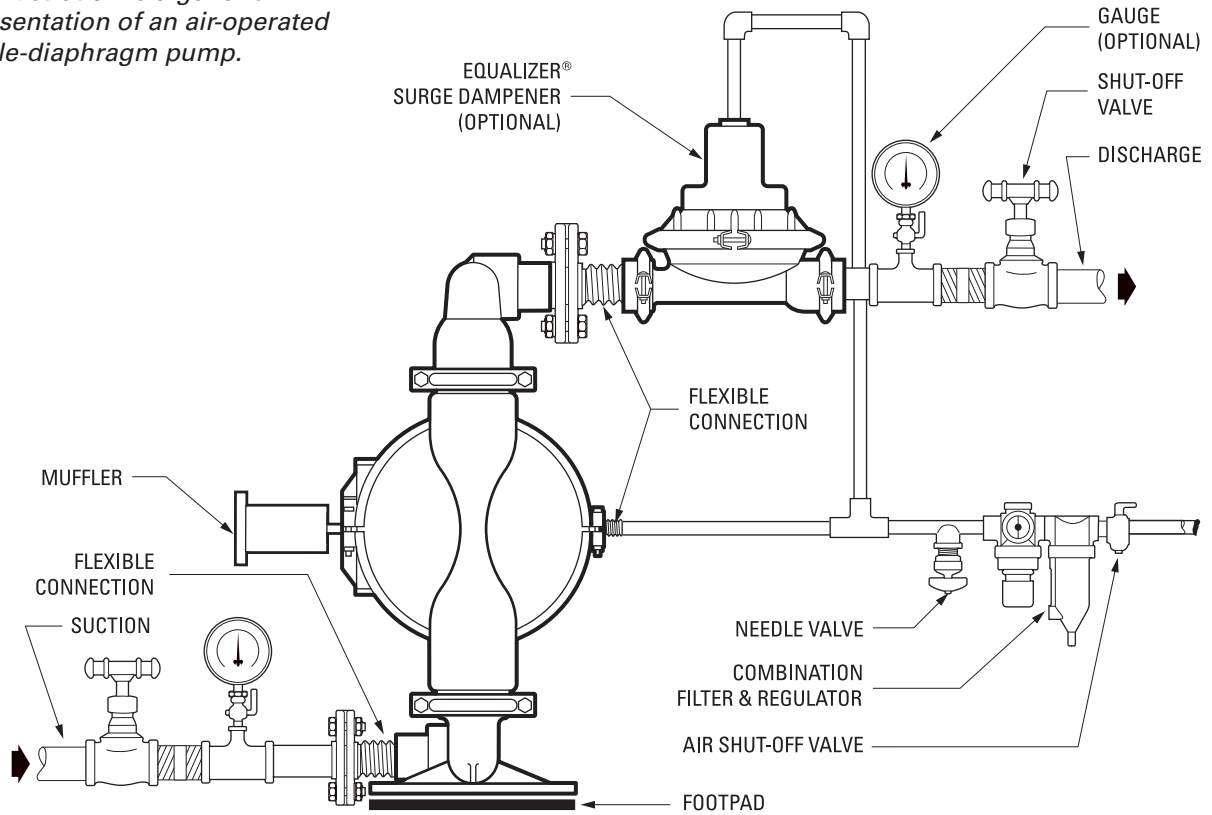

NOTE: In the event of a power failure, the shut-off valve should be closed, if the restarting of the pump is not desirable once power is regained.

AIR-OPERATED PUMPS: To stop the pump from operating in an emergency situation, simply close

the shut-off valve (user-supplied) installed in the air supply line. A properly functioning valve will stop the air supply to the pump, therefore stopping output. This shut-off valve should be located far enough away from the pumping equipment such that it can be reached safely in an emergency situation.

SUGGESTED OPERATION & MAINTENANCE

OPERATION: The P800 and PX800 are pre-lubricated and do not require in-line lubrication. Additional lubrication will not damage the pump; however, if the pump is heavily lubricated by an external source, the pump's internal lubrication may be washed away. If the pump is then moved to a non-lubricated location, it may need to be disassembled and re-lubricated as described in the DISASSEMBLY/REASSEMBLY INSTRUCTIONS.

Pump discharge rate can be controlled by limiting the volume and/or pressure of the air supply to the pump. An air regulator is used to regulate air pressure. A needle valve is used to regulate volume. Pump discharge rate can also be controlled by throttling the pump discharge by partially closing a valve in the discharge line of the pump. This action increases friction loss which reduces flow rate. (See Section 5.) This is useful when the need exists to control the pump from a remote location. When the pump discharge pressure equals or exceeds the air supply pressure, the pump will stop; no bypass or pressure relief valve is needed, and pump damage will not occur. The pump has reached a "deadhead" situation and can

be restarted by reducing the fluid discharge pressure or increasing the air inlet pressure. The Wilden P800 and PX800 pumps run solely on compressed air and do not generate heat, therefore your process fluid temperature will not be affected.

MAINTENANCE AND INSPECTIONS: Since each application is unique, maintenance schedules may be different for every pump. Frequency of use, line pressure, viscosity and abrasiveness of process fluid all affect the parts life of a Wilden pump. Periodic inspections have been found to offer the best means for preventing unscheduled pump downtime. Personnel familiar with the pump's construction and service should be informed of any abnormalities that are detected during operation.

RECORDS: When service is required, a record should be made of all necessary repairs and replacements. Over a period of time, such records can become a valuable tool for predicting and preventing future maintenance problems and unscheduled downtime. In addition, accurate records make it possible to identify pumps that are poorly suited to their applications.

TROUBLESHOOTING

Pump will not run or runs slowly.

1. Ensure that the air inlet pressure is at least 0.4 bar (5 psig) above startup pressure and that the differential pressure (the difference between air inlet and liquid discharge pressures) is not less than 0.7 bar (10 psig).
2. Check air inlet filter for debris (see SUGGESTED INSTALLATION).
3. Check for extreme air leakage (blow by) which would indicate worn seals/bores in the air valve, pilot spool and main shaft.
4. Disassemble pump and check for obstructions in the air passageways or objects which would obstruct the movement of internal parts.
5. Check for sticking ball check valves. If material being pumped is not compatible with pump elastomers, swelling may occur. Replace ball check valves and seals with proper elastomers. Also, as the check valve balls wear out, they become smaller and can become stuck in the seats. In this case, replace balls and seats.
6. Check for broken inner piston which will cause the air valve spool to be unable to shift.
7. Remove plug from pilot spool exhaust.

Pump runs but little or no product flows.

1. Check for pump cavitation; slow pump speed down to allow thick material to flow into liquid chambers.

2. Verify that vacuum required to lift liquid is not greater than the vapor pressure of the material being pumped (cavitation).
3. Check for sticking ball check valves. If material being pumped is not compatible with pump elastomers, swelling may occur. Replace ball check valves and seats with proper elastomers. Also, as the check valve balls wear out, they become smaller and can become stuck in the seats. In this case, replace balls and seats.

Pump air valve freezes.

1. Check for excessive moisture in compressed air. Either install a dryer or hot air generator for compressed air. Alternatively, a coalescing filter may be used to remove the water from the compressed air in some applications.

Air bubbles in pump discharge.

1. Check for ruptured diaphragm.
2. Check tightness of outer pistons (refer to Section 7).
3. Check tightness of fasteners and integrity of O-rings and seals, especially at intake manifold.
4. Ensure pipe connections are airtight.

Product comes out air exhaust.

1. Check for diaphragm rupture.
2. Check tightness of outer pistons to shaft.

PUMP DISASSEMBLY

Tools Required:

- 9/16" Wrench
- Adjustable Wrench
- Vise equipped w/ soft jaws (such as plywood, plastic or other suitable material)

CAUTION: Before any maintenance or repair is attempted, the compressed air line to the pump should be disconnected and all air pressure allowed to bleed from the pump. Disconnect all intake, discharge and air lines. Drain the pump by turning it upside down and allowing any fluid to flow into a suitable container. Be aware of any hazardous effects of contact with your process fluid.

NOTE: The model photographed for these instructions incorporates rubber diaphragms, balls and seats. Models may vary depending on materials of construction, elastomer options and specialty codes selected.

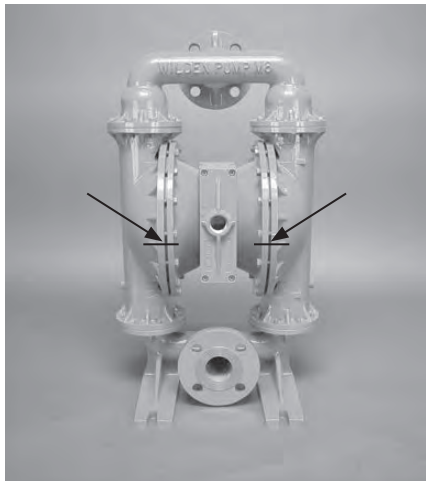

Step 1

Please note alignment marks on liquid chambers. Use to properly align center section to liquid chambers.



Step 2

Using a 9/16" wrench, loosen the discharge manifold from the liquid chambers.



Step 3

Remove the discharge manifold to expose the valve balls and valve seats. Inspect ball cage area of manifold for excessive wear or damage.

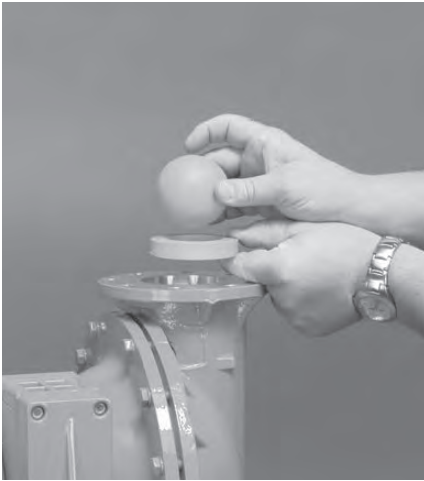

Step 4

After removing discharge valve balls and valve seats from the discharge manifold and liquid chamber, inspect for nicks, gouges, chemical attack or abrasive wear. **NOTE:** Replace worn parts with genuine Wilden parts for reliable performance.

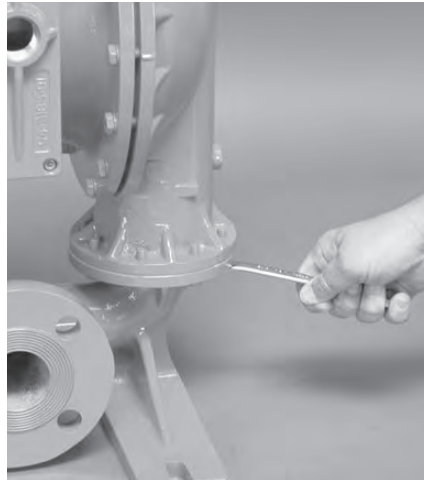

Step 5

Using a 9/16" wrench, loosen the nut from the inlet manifold from the liquid chambers.

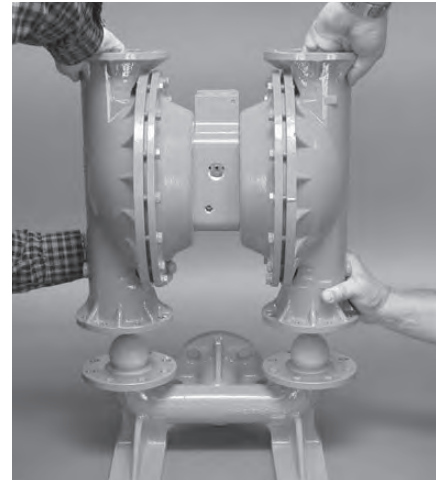

Step 6

Remove the inlet valve balls and valve seats from the inlet manifold and inspect for nicks, gouges, chemical attack or abrasive wear.



Step 7

Using a 9/16" wrench, remove the liquid chamber from the center section.



Step 8

The liquid chamber should be removed to expose the diaphragm and outer piston. Rotate center section and remove opposite liquid chamber.



Step 9

Using two adjustable wrenches or rotating both diaphragms by hand, remove the diaphragm assembly from the center section assembly.



Step 10

After loosening and removing the outer piston, the diaphragm assembly can be disassembled.



Step 11

To remove diaphragm assembly from shaft, secure shaft with soft jaws (a vise fitted with plywood, plastic or other suitable material) to ensure shaft is not nicked, scratched or gouged. Using an adjustable wrench, remove diaphragm assembly from shaft.

AIR VALVE / CENTER SECTION DISASSEMBLY

Tools Required:

- 3/16" Hex-Head Wrench
- 1/4" Hex-Head Wrench
- Snap-Ring Pliers
- O-Ring Pick

CAUTION: Before any maintenance or repair is attempted, the compressed air line to the pump should be disconnected and all air pressure allowed to bleed from the pump. Disconnect all intake, discharge and air lines. Drain the pump by turning it upside down and allowing any fluid to flow into a suitable container. Be aware of hazardous effects of contact with your process fluid.

The P800 metal pump utilizes a revolutionary Pro-Flo® air distribution system. The PX800 metal pump utilizes the Pro-Flo X™ air distribution system. Proprietary composite seals reduce the coefficient of friction and allow the P800 and PX800 to run lube-free. Constructed of acetal, polypropylene or aluminum, the Pro-Flo® air distribution system is designed to perform in on/off, non-freezing, non-stalling, tough-duty applications.



Step 1

Using a 3/16" hex-head wrench, loosen air valve bolts.

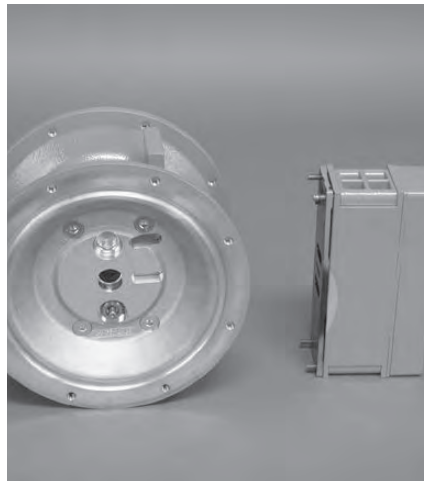

Step 2

Remove muffer plate and air valve bolts from air valve assembly exposing muffer gasket for inspection. Replace if necessary.



Step 3

Lift away air valve assembly and remove air valve gasket for inspection. Replace if necessary.

AIR VALVE / CENTER SECTION DISASSEMBLY



Step 4

Remove air valve end cap to expose air valve spool by simply lifting up on end cap once air valve bolts are removed. **NOTE:** Pro-Flo X™ air valve incorporates an end cap at both ends of the air valve.



Step 5

Remove the air valve spool from the air valve body by threading one air valve bolt into the end of the air valve spool and gently sliding the spool out of the air valve body. Inspect seals for signs of wear and replace entire assembly if necessary. Use caution when handling air valve spool to prevent damaging seals. **NOTE:** Seals should not be removed from assembly. Seals are not sold separately.



Step 6

Remove pilot sleeve retaining snap ring on both sides of center section with snap-ring pliers.



Step 7

Remove pilot spool sleeve from center section.



Step 8

Using an O-ring pick, gently remove the O-ring from the opposite side of the notched end on one side of the pilot spool. Gently remove the pilot spool from pilot spool sleeve and inspect for nicks, gouges and wear. Replace pilot sleeve or outer sleeve O-rings if necessary. During re-assembly, never insert the pilot spool into the sleeve with the notched end first, this end incorporates the urethane O-ring and will be damaged as it slides over the ports cut in the sleeve. **NOTE:** Seals should not be removed from pilot spool. Seals are not sold separately.

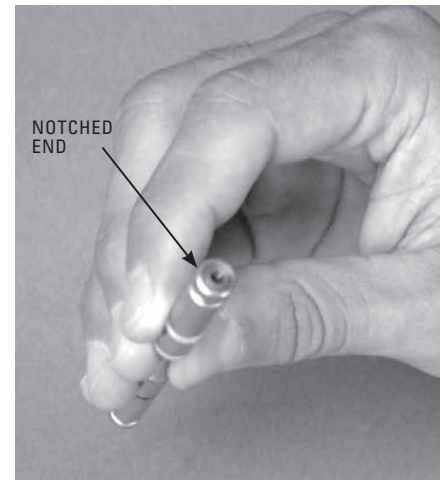

AIR VALVE / CENTER SECTION DISASSEMBLY

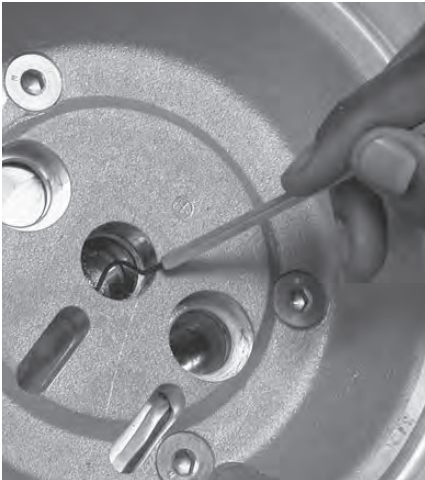

Step 9

Check center section shaft seals for signs of wear. If necessary, remove the shaft seals with O-ring pick and replace.

SINGLE-POINT EXHAUST PRO-FLO X™

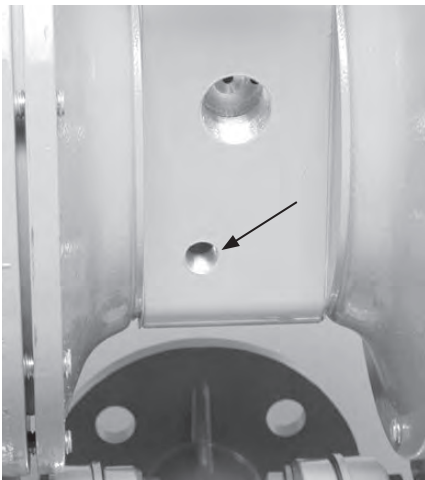

Step 1

Install a 1/4" NPT pipe plug (00-7010-08) into the pilot spool bleed port located at the front of the center block.

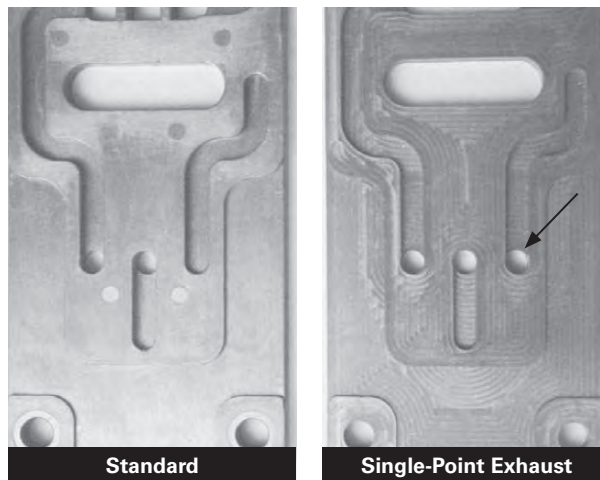

Step 2

Next, install an optional single-point exhaust gasket (04-2621-52). The single-point exhaust gasket can be purchased as a spare part or included with the purchase of a new Pro-Flo X™ pump.

ASSEMBLY:

Upon performing applicable maintenance to the air distribution system, the pump can now be reassembled. Please refer to the disassembly instructions for photos and parts placement. To reassemble the pump, follow the disassembly instructions in reverse order. The air distribution system needs to be assembled first, then the diaphragms and finally the wetted path. Please find the applicable torque specifications on this page. The following tips will assist in the assembly process.

- Lubricate air valve bore, center section shaft and pilot spool bore with NLGI grade 2 white EP bearing grease or equivalent.
- Clean the inside of the center section shaft bore to ensure no damage is done to new shaft seals.
- A small amount of NLGI grade 2 white EP bearing grease can be applied to the muffler and air valve gaskets to locate gaskets during assembly.
- Make sure that the exhaust port on the muffler plate is centered between the two exhaust ports on the center section.
- Stainless bolts should be lubed to reduce the possibility of seizing during tightening.
- Use a mallet to tamp lightly on the large clamp bands to seat the diaphragm before tightening.

PRO-FLO® MAXIMUM TORQUE SPECIFICATIONS

Description of Part	Torque
Air Valve	5.1 N•m (45 in-lb)
Air Chamber/Center Block	27.1 N•m (20 ft-lb)
Liquid Chamber/Air Chamber, Aluminum Bolted Only	27.1 N•m (20 ft-lb)
Liquid Chamber/Air Chamber, Stainless-Steel Bolted Only	54.2 N•m (40 ft-lb)
Outer Pistons, Rubber & PTFE, Excluding Stainless-Steel Inner Pistons	109 N•m (80 ft-lb)
Outer Pistons, Rubber & PTFE, Stainless-Steel Inner Pistons	119 N•m (88 ft-lb)
Outer Pistons, Ultra-Flex™	74.6 N•m (55 ft-lb)

PRO-FLO X™ MAXIMUM TORQUE SPECIFICATIONS

Description of Part	Torque
Air Valve	13.6 N•m (120 in-lb)
Air Chamber/Center Block	27.1 N•m (20 ft-lb)
Liquid Chamber/Air Chamber, Aluminum Bolted Only	27.1 N•m (20 ft-lb)
Liquid Chamber/Air Chamber, Stainless-Steel Bolted Only	54.2 N•m (40 ft-lb)
Outer Pistons, Rubber & PTFE, Excluding Stainless-Steel Inner Pistons	109 N•m (80 ft-lb)
Outer Pistons, Rubber & PTFE, Stainless-Steel Inner Pistons	119 N•m (88 ft-lb)
Outer Pistons, Ultra-Flex™	74.6 N•m (55 ft-lb)

Figure A

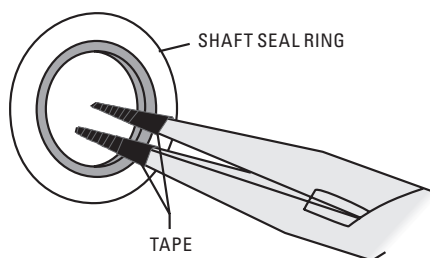

SHAFT SEAL INSTALLATION:

PRE-INSTALLATION

- Once all of the old seals have been removed, the inside of the bushing should be cleaned to ensure no debris is left that may cause premature damage to the new seals.

INSTALLATION

The following tools can be used to aid in the installation of the new seals:

- Needle Nose Pliers
- Phillips Screwdriver
- Electrical Tape

- Wrap electrical tape around each leg of the needle nose pliers (heat shrink tubing may also be used). This is done to prevent damaging the inside surface of the new seal.
- With a new seal in hand, place the two legs of the needle nose pliers inside the seal ring. (See Figure A.)
- Open the pliers as wide as the seal diameter will allow, then with two fingers pull down on the top portion of the seal to form kidney bean shape. (See Figure B.)
- Lightly clamp the pliers together to hold the seal into the kidney shape. Be sure to pull the seal into as tight of a kidney shape as possible, this will allow the seal to travel down the bushing bore easier.
- With the seal clamped in the pliers, insert the seal into the bushing bore and position the bottom of the seal into the correct groove. Once the bottom of the seal is seated in the groove, release the clamp pressure on the pliers. This will allow the seal to partially snap back to its original shape.
- After the pliers are removed, you will notice a slight bump in the seal shape. Before the seal can be properly resized, the bump in the seal should be removed as much as possible. This can be done with either the Phillips screwdriver or your finger. With either the side of the screwdriver or your finger, apply light pressure to the peak of the bump. This pressure will cause the bump to be almost completely eliminated.
- Lubricate the edge of the shaft with NLGI grade 2 white EP bearing grease.
- Slowly insert the center shaft with a rotating motion. This will complete the resizing of the seal.
- Perform these steps for the remaining seal.

Figure B

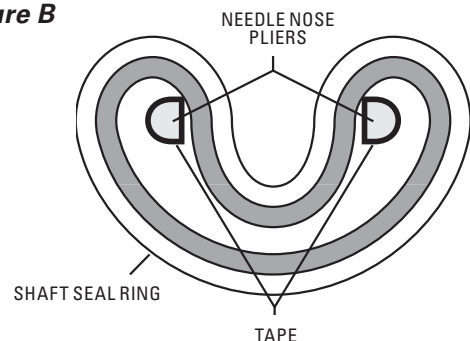

EXPLODED VIEW & PARTS LISTING

P800 ALUMINUM

Rubber/TPE/PTFE/Ultra-Flex™-Fitted

EXPLODED VIEW

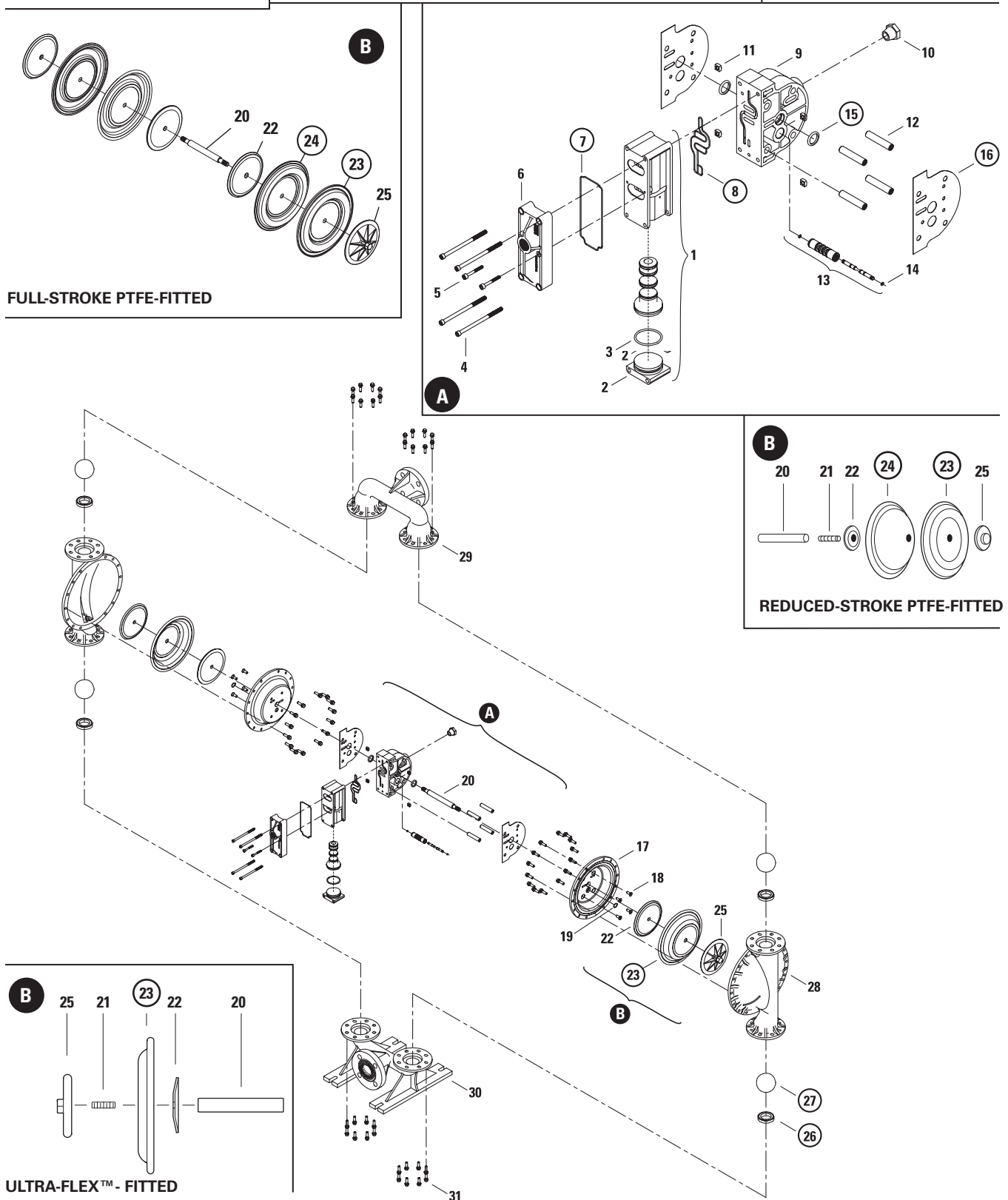

ALL CIRCLED PART IDENTIFIERS ARE INCLUDED IN REPAIR KITS (see Section 9).

EXPLODED VIEW & PARTS LISTING

P800 ALUMINUM Rubber/TPE/PTFE/Ultra-Flex™-Fitted PARTS LISTING

No.	Part Description	Qty.	FULL STROKE DIAPHRAGM-FITTED	REDUCED STROKE DIAPHRAGM-FITTED
			P800/AAPP P/N	P800/AAPP P/N
1	Air Valve Assembly ¹ , Pro-Flo®	1	04-2000-20-700	04-2000-20-700
2	O-Ring (-225), End Cap (1.859 x .139)	1	04-2390-52-700	04-2390-52-700
3	End Cap, Pro-Flo®	1	04-2330-20-700	04-2330-20-700
4	Screw, HCH, Air Valve (1/4"-20 x 4-1/2")	4	01-6000-03	01-6000-03
5	Screw, SCH, Air Valve (10-16 x 1-3/4")	2	04-6351-03	04-6351-03
6	Muffler Plate, Pro-Flo®	1	04-3180-20-700	04-3180-20-700
7	Gasket, Muffler Plate, Pro-Flo®	1	04-3500-52-700	04-3500-52-700
8	Gasket, Air Valve, Pro-Flo®	1	04-2600-52-700	04-2600-52-700
9	Center Block Assembly, Pro-Flo®	1	04-3110-20	04-3110-20
10	Bushing, Reducer	1	04-6950-20-700	04-6950-20-700
11	Nut, Square (1/4" 20)	4	00-6505-03	00-6505-03
12	Sleeve, Threaded, Pro-Flo®	4	04-7710-08	04-7710-08
13	Pilot Sleeve Assembly	1	04-3880-99	04-3880-99
14	Pilot Spool Retaining O-Ring	2	04-2650-49-700	04-2650-49-700
15	Shaft Seal	2	08-3210-55-225	08-3210-55-225
16	Gasket, Center Block, Pro-Flo®	2	04-3526-52	04-3526-52
17	Air Chamber, Pro-Flo®	2	08-3681-01	08-3681-01
18	Screw, HSFHS (3/8"-16 x 1")	8	71-6250-08	71-6250-08
19	Retaining Ring	2	04-3890-03	04-3890-03
20	Shaft	1	08-3812-03	08-3840-09
	Shaft, Ultra-Flex™	1	N/A	08-3841-03
21	Shaft Stud	2	N/A	08-6152-08
	Shaft Stud, Ultra-Flex™	2	N/A	08-6150-08
22	Inner Piston	2	08-3700-01	08-3750-01
	Inner Piston, Ultra-Flex™	2	N/A	08-3761-01
23	Diaphragm	2	*	*
24	Diaphragm, Back-Up	2	*	*
25	Outer Piston	2	08-4550-01	08-4600-01
	Outer Piston, Ultra-Flex™	2	N/A	04-4552-01
26	Seat, Valve	4	*	08-1121-01
27	Ball, Balve	4	*	08-1080-55
	Valve Seat O-Ring (not shown)	4	*	08-1200-55
28	Liquid Chamber	2	08-5000-01-42	08-5000-01-42
29	Discharge Manifold, ANSI/DIN combo	1	08-5020-01-42	08-5020-01-42
30	Inlet Manifold, ANSI/DIN combo	1	08-5080-01-42	08-5080-01-42
31	Screw, HHCS (3/8"-16 x 1-1/4")	60	08-6185-08	08-6185-08
	Muffler (Not Shown)	1	08-3510-99	08-3510-99

*See elastomer chart - Section 9.

¹Air Valve Assembly includes item numbers 2 and 3.

All boldface items are primary wear parts.

EXPLODED VIEW & PARTS LISTING

P800 STAINLESS STEEL

Rubber/TPE/PTFE/Ultra-Flex™-Fitted

EXPLODED VIEW

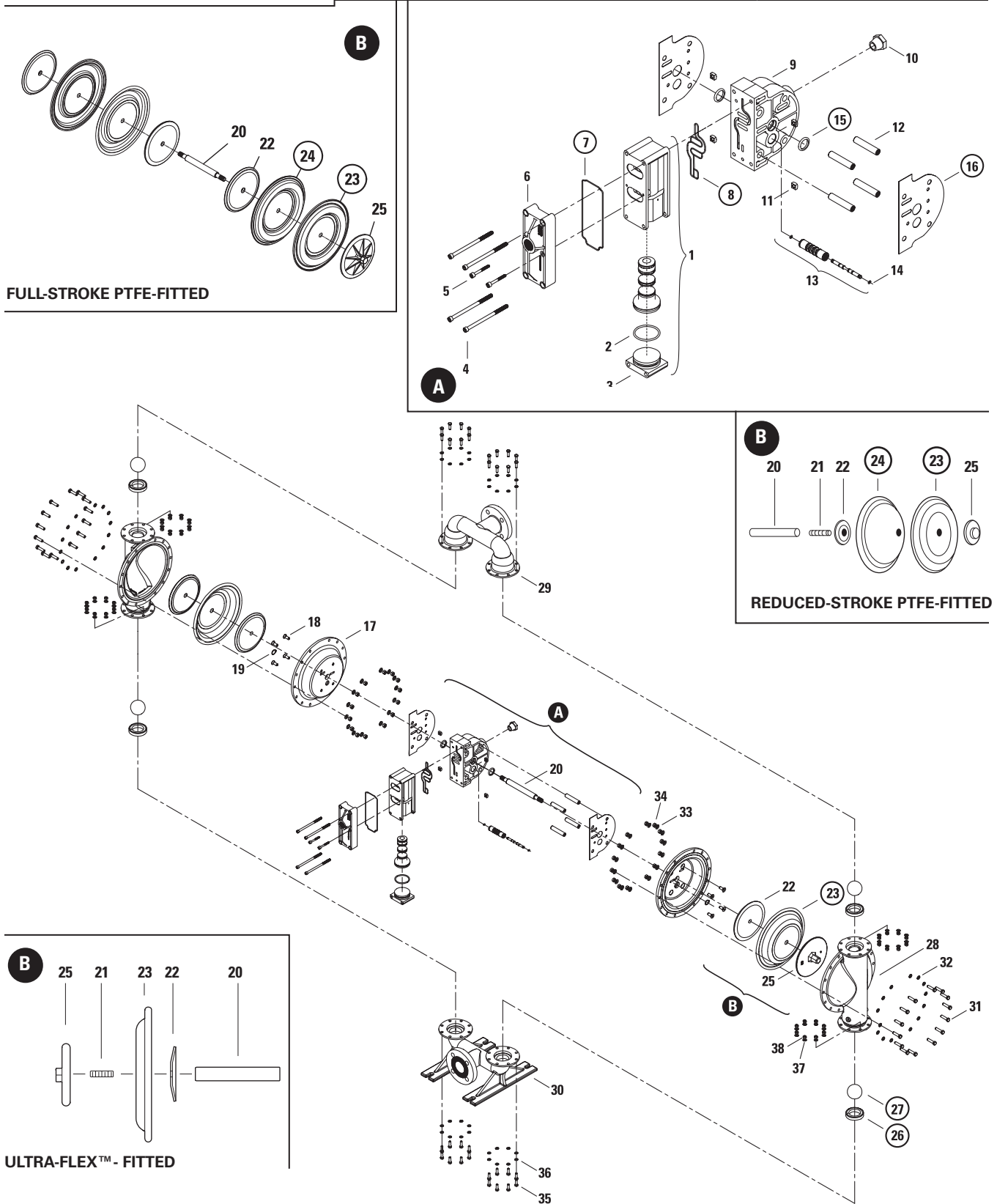

FULL-STROKE PTFE-FITTED

REDUCED-STROKE PTFE-FITTED

ULTRA-FLEX™ - FITTED

ALL CIRCLED PART IDENTIFIERS ARE INCLUDED IN REPAIR KITS (see Section 9).

EXPLODED VIEW & PARTS LISTING

P800 STAINLESS STEEL Rubber/TPE/PTFE/Ultra-Flex™-Fitted PARTS LISTING

No.	Part Description	Qty.	FULL STROKE DIAPHRAGM-FITTED		REDUCED STROKE DIAPHRAGM-FITTED	
			P800/SSAPP P/N	P800/HHAPP P/N	P800/SSAPP P/N	P800/HHAPP P/N
1	Air Valve Assembly ¹ , Pro-Flo®	1	04-2000-20-700	04-2000-20-700	04-2000-20-700	04-2000-20-700
2	O-Ring (-225), End Cap (1.859 x .139)	1	04-2390-52-700	04-2390-52-700	04-2390-52-700	04-2390-52-700
3	End Cap, Pro-Flo®	1	04-2330-20-700	04-2330-20-700	04-2330-20-700	04-2330-20-700
4	Screw, HHC, Air Valve (1/4"-20 x 4-1/2")	4	01-6000-03	01-6000-03	01-6000-03	01-6000-03
5	Screw, SCHS, Air Valve (10-16 X 1-3/4")	2	04-6351-03	04-6351-03	04-6351-03	04-6351-03
6	Muffler Plate, Pro-Flo®	1	04-3180-20-700	04-3180-20-700	04-3180-20-700	04-3180-20-700
7	Gasket, Muffler Plate, Pro-Flo®	1	04-3500-52-700	04-3500-52-700	04-3500-52-700	04-3500-52-700
8	Gasket, Air Valve, Pro-Flo®	1	04-2600-52-700	04-2600-52-700	04-2600-52-700	04-2600-52-700
9	Center Block Assembly, Pro-Flo®	1	04-3110-20	04-3110-20	04-3110-20	04-3110-20
10	Bushing, Reducer	1	04-6950-20-700	04-6950-20-700	04-6950-20-700	04-6950-20-700
11	Nut, Square (1/4" 20)	4	00-6505-03	00-6505-03	00-6505-03	00-6505-03
12	Sleeve, Threaded, Pro-Flo®	4	04-7710-08	04-7710-08	04-7710-08	08-3840-09
13	Pilot Sleeve Assembly	1	04-3880-99	04-3880-99	04-3880-99	04-3880-99
14	Pilot Spool Retaining O-Ring	2	04-2650-49-700	04-2650-49-700	04-2650-49-700	04-2650-49-700
15	Shaft Seal	2	08-3210-55-225	08-3210-55-225	08-3210-55-225	08-3210-55-225
16	Gasket, Center Block, Pro-Flo®	2	04-3526-52	04-3526-52	04-3526-52	04-3526-52
17	Air Chamber, Pro-Flo®	2	08-3681-01	08-3681-01	08-3681-01	08-3681-01
18	Screw, HSFHS (3/8"-16 x 1")	8	71-6250-08	71-6250-08	71-6250-08	71-6250-08
19	Retaining Ring	2	04-3890-03	04-3890-03	04-3890-03	04-3890-03
20	Shaft	1	08-3812-03	08-3812-03	08-3840-09	08-3840-09
	Shaft, Ultra-Flex™	1	N/A	N/A	08-3841-03	08-3841-03
21	Shaft Stud, Teflon	2	N/A	N/A	08-6152-08	08-6152-08
	Shaft Stud, Ultra-Flex™	2	N/A	N/A	08-6150-08	08-6150-08
22	Inner Piston	2	08-3700-01	08-3700-01	08-3750-01	08-3750-01
	Inner Piston, Ultra-Flex™	2	N/A	N/A	08-3761-01	08-3761-01
23	Diaphragm	2	*	*	*	*
24	Diaphragm, Back-Up	2	*	*	*	*
25	Outer Piston	2	08-4550-03	08-4550-04	08-4600-03	08-4600-04
	Outer Piston, Ultra-Flex™	2	N/A	N/A	04-4550-03	04-4550-04
26	Seat, Valve	4	*	*	08-1121-03	08-1121-04
27	Ball, Balve	4	*	*	08-1080-55	08-1080-55
	Valve Seat O-Ring (not shown)	4	*	*	08-1200-55	08-1200-55
28	Liquid Chamber	2	08-5000-03-40	08-5000-04-40	08-5000-03-40	08-5000-04-40
29	Discharge Manifold, ANSI	1	08-5020-03-42	08-5020-04-42	08-5020-03-42	08-5020-04-42
	Discharge Manifold, DIN	1	08-5020-03-43	08-5020-04-43	08-5020-03-43	08-5020-04-43
30	Inlet Manifold, ANSI	1	08-5080-03-42	08-5080-04-42	08-5080-03-42	08-5080-04-42
	Inlet Manifold, DIN	1	08-5080-03-43	08-5080-04-43	08-5080-03-43	08-5080-04-43
31	Screw, HHC (3/8"-16 x 1-1/2")	28	08-6190-03-42	08-6190-03-42	08-6190-03-42	08-6190-03-42
32	Flat Washer (3/8")	28	02-6730-03	02-6730-03	02-6730-03	02-6730-03
33	Disc Spring (3/8")	28	08-6820-03-42	08-6820-03-42	08-6820-03-42	08-6820-03-42
34	Hex Nut (3/8"-16)	28	02-6430-03	02-6430-03	02-6430-03	02-6430-03
35	Screw, HHC (5/16"-18 x 1")	32	08-6180-03-42	08-6180-03-42	08-6180-03-42	08-6180-03-42
36	Flat Washer (5/16")	32	08-6730-03-42	08-6730-03-42	08-6730-03-42	08-6730-03-42
37	Disc Spring (5/16")	32	08-6810-03-42	08-6810-03-42	08-6810-03-42	08-6810-03-42
38	Hex Nut (5/16"-18)	32	08-6400-03	08-6400-03	08-6400-03	08-6400-03
	Muffler (Not Shown)	1	08-3510-99	08-3510-99	08-3510-99	08-3510-99

*See elastomer chart - Section 9.

¹Air Valve Assembly includes item numbers 2 and 3.

All boldface items are primary wear parts.

EXPLODED VIEW & PARTS LISTING

PX800 ALUMINUM

Rubber/TPE/PTFE/Ultra-Flex™-Fitted

EXPLODED VIEW

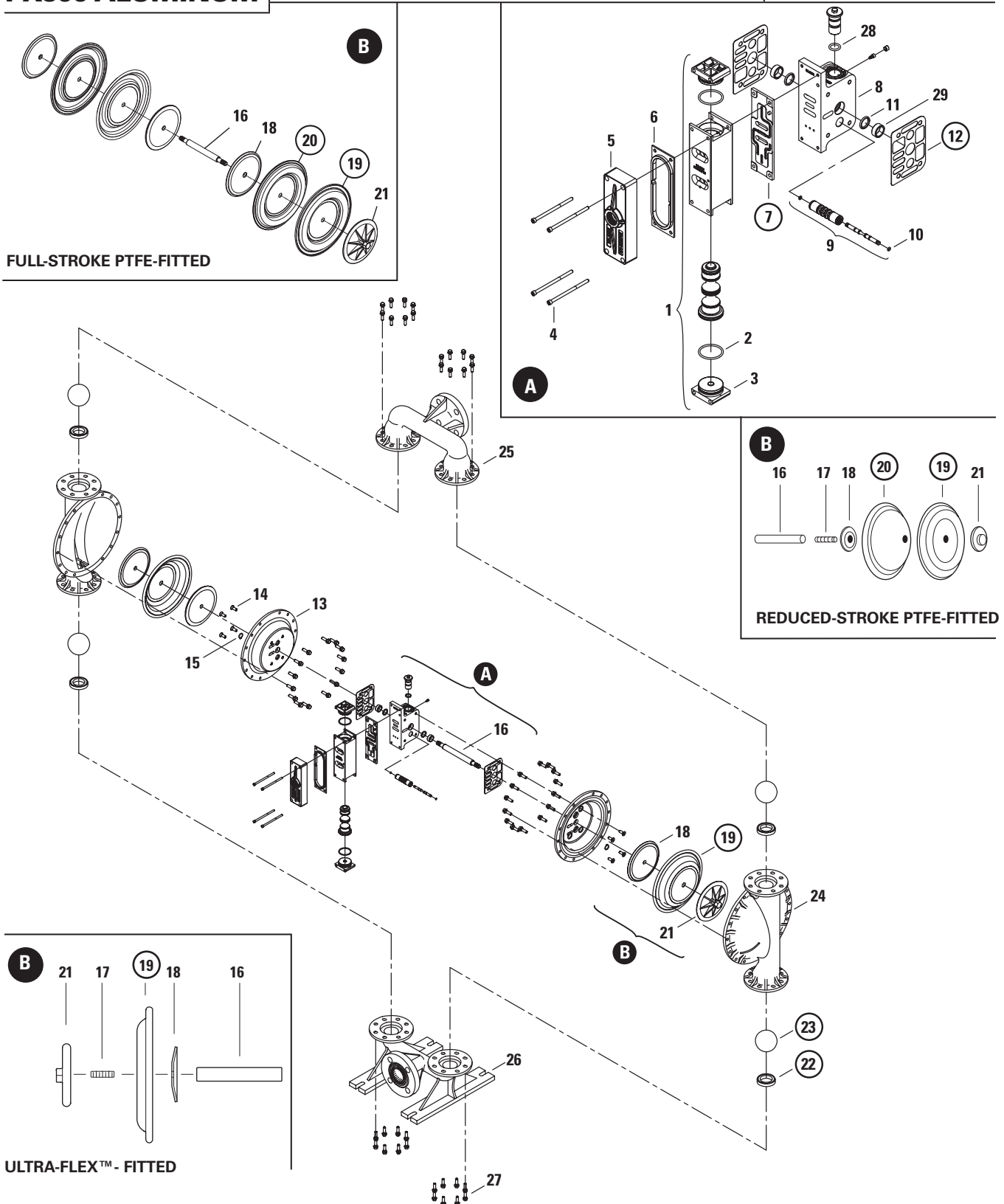

FULL-STROKE PTFE-FITTED

REDUCED-STROKE PTFE-FITTED

ULTRA-FLEX™ - FITTED

ALL CIRCLED PART IDENTIFIERS ARE INCLUDED IN REPAIR KITS (see Section 9).

EXPLODED VIEW & PARTS LISTING

PX800 ALUMINUM Rubber/TPE/PTFE/Ultra-Flex™-Fitted PARTS LISTING

No.	Part Description	Qty.	FULL STROKE DIAPHRAGM-FITTED	REDUCED STROKE DIAPHRAGM-FITTED
			PX800/AAAAA P/N	PX800/AAAAA P/N
1	Air Valve Assembly ¹ , PRO-FLO X™	1	04-2030-01	04-2030-01
2	O-Ring (-225), End Cap (1.859 x .139)	2	04-2390-52-700	04-2390-52-700
3	End Cap, PRO-FLO X™	2	04-2340-01	04-2340-01
4	Screw, SCH, Air Valve (1/4"-20 x 4-1/2")	4	01-6000-03	01-6000-03
5	Muffler Plate, PRO-FLO X™	1	04-3185-01	04-3185-01
6	Gasket, Muffler Plate, PRO-FLO X™	1	04-3502-52	04-3502-52
7	Gasket, Air Valve, PRO-FLO X™	1	04-2620-52	04-2620-52
8	Center Block Assembly, PRO-FLO X™	1	08-3126-01	08-3126-01
9	Pilot Sleeve Assembly	1	04-3880-99	04-3880-99
10	Pilot Spool Retaining O-Ring	2	04-2650-49-700	04-2650-49-700
11	Shaft Seal	2	08-3210-55-225	08-3210-55-225
12	Gasket, Center Block, PRO-FLO X™	2	04-3528-52	04-3528-52
13	Air Chamber, PRO-FLO X™	2	08-3690-01	08-3690-01
14	Screw, HSFHS (3/8"-16 x 1")	8	71-6250-08	71-6250-08
15	Retaining Ring	2	04-3890-03	04-3890-03
16	Shaft	1	08-3812-03	08-3840-09
	Shaft, Ultra-Flex™	1	N/A	08-3841-03
17	Shaft Stud, PTFE	2	N/A	08-6152-08
	Shaft Stud, Ultra-Flex™	2	N/A	08-6150-08
18	Inner Piston	2	08-3700-01	08-3750-01
	Inner Piston, Ultra-Flex™	2	N/A	08-3761-01
19	Diaphragm	2	*	*
20	Diaphragm, Back-Up	2	*	*
21	Outer Piston	2	08-4550-01	08-4600-01
	Outer Piston, Ultra-Flex™	2	N/A	04-4552-01
22	Seat, Valve	4	*	08-1121-01
23	Ball, Balve	4	*	08-1080-55
	Valve Seat O-Ring (not shown)	4	*	08-1200-55
24	Liquid Chamber	2	08-5000-01-42	08-5000-01-42
25	Discharge Manifold, ANSI/DIN combo	1	08-5020-01-42	08-5020-01-42
26	Inlet Manifold, ANSI/DIN combo	1	08-5080-01-42	08-5080-01-42
27	Screw, HHCS (3/8"-16 x 1-1/4")	60	08-6185-08	08-6185-08
28	O-ring (-206), Air Adjustment Pin (.484 x .139)	1	02-3200-52	02-3200-52
29	Shaft Bushings	2	08-3306-13	08-3306-13
	Muffler (Not Shown)	1	15-3510-99R	15-3510-99R

*See elastomer chart - Section 9.

¹Air Valve Assembly includes item numbers 2 and 3.

²Center-Block Assembly includes items 11, 28 and 29.

All boldface items are primary wear parts.

EXPLODED VIEW & PARTS LISTING

PX800 STAINLESS STEEL

Rubber/TPE/PTFE/Ultra-Flex™-Fitted

EXPLODED VIEW

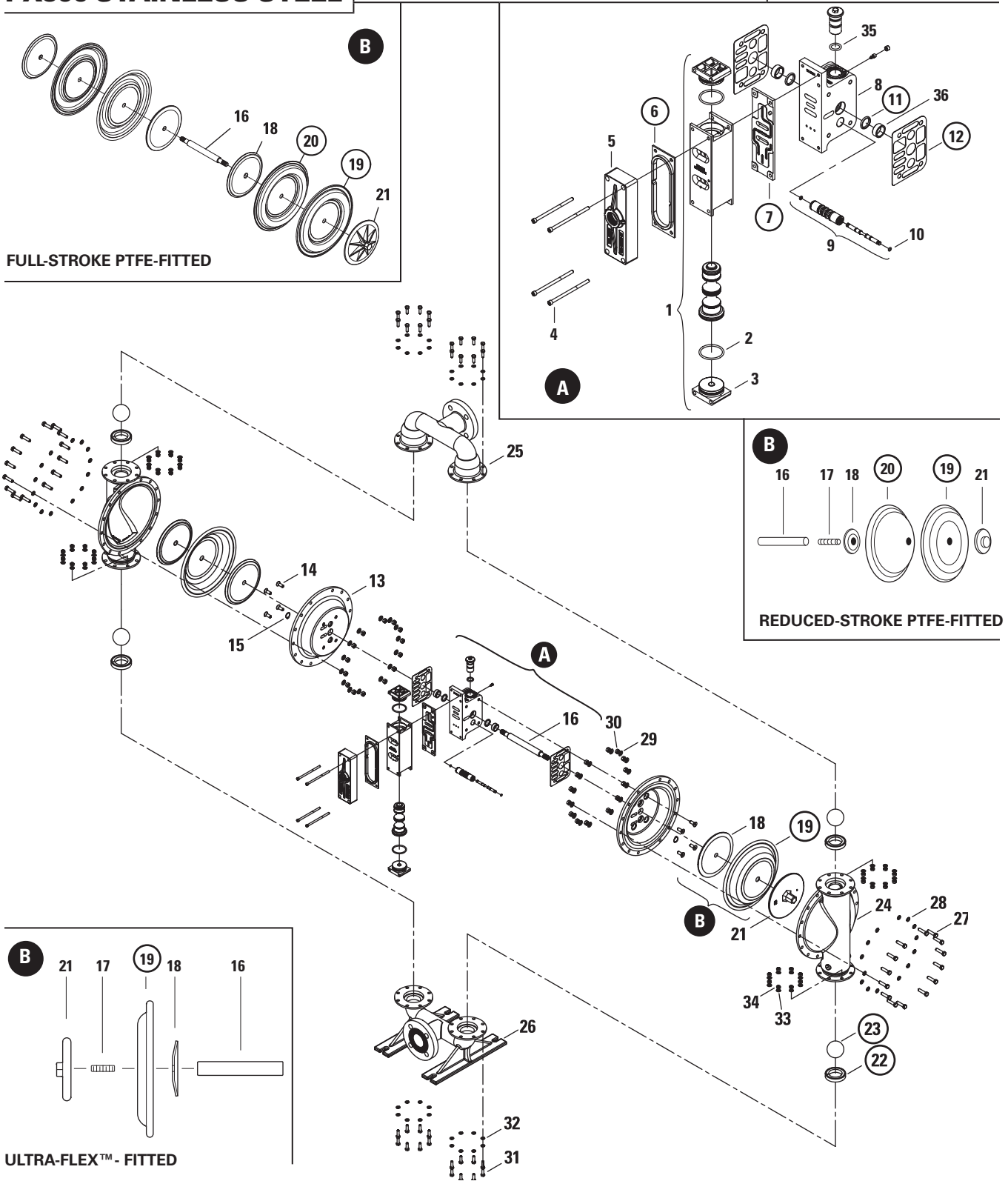

ALL CIRCLED PART IDENTIFIERS ARE INCLUDED IN REPAIR KITS (see Section 9).

PX800 STAINLESS STEEL Rubber/TPE/PTFE/Ultra-Flex™-Fitted PARTS LISTING

No.	Part Description	Qty.	FULL STROKE DIAPHRAGM-FITTED			REDUCED STROKE DIAPHRAGM-FITTED		
			PX800/SSAAA P/N	PX800/HHAAA P/N	PX800/SSSSS P/N	PX800/SSAAA P/N	PX800/HHAAA P/N	PX800/SSSSS P/N
1	Pro-Flo X™ Assembly, Air Valve ¹	1	04-2030-01	04-2030-01	04-2030-03	04-2030-01	04-2030-01	04-2030-03
2	O-Ring (-225), End Cap (1.859 x .139)	2	04-3290-52-700	04-3290-52-700	04-3290-52-700	04-3290-52-700	04-3290-52-700	04-3290-52-700
3	End Cap	2	04-2340-01	04-2340-01	04-2340-03	04-2340-01	04-2340-01	04-2340-03
4	Screw, SHC, Air Valve (1/4"-20 x 4 1/2")	4	01-6000-03	01-6000-03	01-6000-03	01-6000-03	01-6000-03	01-6000-03
5	Muffler Plate, Pro-Flo V™	1	04-3185-01	04-3185-01	04-3185-03	04-3185-01	04-3185-01	04-3185-03
6	Gasket, Muffler Plate, Pro-Flo V™	1	04-3502-52	04-3502-52	04-3502-52	04-3502-52	04-3502-52	04-3502-52
7	Gasket, Air Valve, Pro-Flo V™	1	04-2620-52	04-2620-52	04-2620-52	04-2620-52	04-2620-52	04-2620-52
8	Center Block Assembly, Pro-Flo X™ ²	1	08-3126-01	08-3126-01	08-3126-03	08-3126-01	08-3126-01	08-3126-03
9	Pilot Sleeve Assembly	1	04-3880-99	04-3880-99	04-3880-99	04-3880-99	04-3880-99	04-3880-99
10	Pilot Spool Retaining O-Ring	2	04-2650-49-700	04-2650-49-700	04-2650-49-700	04-2650-49-700	04-2650-49-700	04-2650-49-700
11	Shaft Seal	2	08-3210-55-225	08-3210-55-225	08-3210-55-225	08-3210-55-225	08-3210-55-225	08-3210-55-225
12	Gasket, Center Block Pro-Flo V™	2	04-3529-52	04-3529-52	04-3529-52	04-3529-52	04-3529-52	04-3529-52
13	Air Chamber, Pro-Flo	2	08-3690-01	08-3690-01	08-3690-03	08-3690-01	08-3690-01	08-3690-03
14	Screw, HSFHS (3/8"-16 x 1")	8	71-6250-08	71-6250-08	71-6250-08	71-6250-08	71-6250-08	71-6250-08
15	Retaining Ring	2	04-3890-03	04-3890-03	04-3890-03	04-3890-03	04-3890-03	04-3890-03
16	Shaft	1	08-3812-03	08-3812-03	08-3812-03	08-3840-09	08-3840-09	08-3840-09
	Shaft, Ultra-Flex™	1	N/A	N/A	N/A	08-3841-03	08-3841-03	08-3841-03
17	Shaft Stud, PTFE	2	N/A	N/A	N/A	08-6152-08	08-6152-08	08-6152-08
	Shaft Stud, Ultra-Flex™	2	N/A	N/A	N/A	08-6150-08	08-6150-08	08-6150-08
18	Piston, Inner	2	08-3700-01	08-3700-01	08-3700-03	08-3750-01	08-3750-01	08-3752-03
	Piston Inner, Ultra-Flex™	2	N/A	N/A	N/A	08-3761-01	08-3761-01	08-3761-01
19	Diaphragm	2	*	*	*	*	*	*
20	Diaphragm, Back-Up	2	*	*	*	*	*	*
21	Piston, Outer	2	08-4550-03	08-4550-04	08-4550-03	08-4600-03	08-4600-04	08-4600-03
	Piston Outer, Ultra-Flex™	2	N/A	N/A	N/A	04-4550-03	04-4550-04	04-4550-03
22	Seat, Valve	4	*	*	*	08-1121-03	04-1121-04	08-1121-03
23	Ball, Valve	4	*	*	*	08-1080-55	08-1080-55	08-1080-55
	Valve Seat O-ring (Not Shown)	4	*	*	*	08-1200-55	08-1200-55	08-1200-55
24	Liquid Chamber	2	08-5000-03-40	08-5000-04-40	08-5000-03-40	08-5000-03-40	08-5000-04-40	08-5000-03-40
25	Manifold, Discharge, ANSI	1	08-5020-03-42	08-5020-04-42	08-5020-03-42	08-5020-03-42	08-5020-04-42	08-5020-03-42
	Manifold, Discharge, DIN	1	08-5020-03-43	08-5020-04-43	08-5020-03-43	08-5020-03-43	08-5020-04-43	08-5020-03-43
26	Manifold, Inlet, ANSI	1	08-5080-03-42	08-5080-04-42	08-5080-03-42	08-5080-03-42	08-5080-04-42	08-5080-03-42
	Manifold, Inlet, DIN	1	08-5080-03-43	08-5080-04-43	08-5080-03-43	08-5080-03-43	08-5080-04-43	08-5080-03-43
27	Screw, HHC (3/8"-16 x 1-1/2")	28	08-6190-03-42	08-6190-03-42	08-6190-03-42	08-6190-03-42	08-6190-03-42	08-6190-03-42
28	Washer, Flat, (3/8")	28	02-6730-03	02-6730-03	02-6730-03	02-6730-03	02-6730-03	02-6730-03
29	Disc Spring (3/8")	28	08-6820-03-42	08-6820-03-42	08-6820-03-42	08-6820-03-42	08-6820-03-42	08-6820-03-42
30	Hex Nut (3/8"-16)	28	02-6430-03	02-6430-03	02-6430-03	02-6430-03	02-6430-03	02-6430-03
31	Screw, HHC (5/16"-18 x 1")	32	08-6180-03-42	08-6180-03-42	08-6180-03-42	08-6180-03-42	08-6180-03-42	08-6180-03-42
32	Washer, Flat, (5/16")	32	08-6730-03-42	08-6730-03-42	08-6730-03-42	08-6730-03-42	08-6730-03-42	08-6730-03-42
33	Disc Spring (5/16")	32	08-6810-03-42	08-6810-03-42	08-6810-03-42	08-6810-03-42	08-6810-03-42	08-6810-03-42
34	Hex Nut (5/16"-18)	32	08-6400-03	08-6400-03	08-6400-03	08-6400-03	08-6400-03	08-6400-03
35	O-Ring (-210), Adjuster (Ø.734" x Ø.139")	1	02-3200-52	02-3200-52	02-3200-52	02-3200-52	02-3200-52	02-3200-52
36	Bushing, Shaft	2	08-3306-13	08-3306-13	08-3306-13	08-3306-13	08-3306-13	08-3306-13
	Muffler (not shown)	1	15-3510-99R	15-3510-99R	15-3510-99R	15-3510-99R	15-3510-99R	15-3510-99R

*See elastomer chart - Section 9.

¹ Air Valve Assembly includes items 2 and 3.

² Center-Block Assembly includes items 11, 35 and 36.

All boldface items are primary wear parts.

ELASTOMER OPTIONS

P800 & PX800 METAL

MATERIAL	DIAPHRAGMS (2)	ULTRA-FLEX™ DIAPHRAGMS (2)	REDUCED-STROKE BACK-UP DIAPHRAGMS (2)	VALVE BALLS (4)	VALVE SEATS (4)	VALVE SEAT O-RINGS (4)	FULL-STROKE BACK UP DIAPHRAGMS (2)
Polyurethane	08-1010-50	N/A	N/A	08-1080-50	08-1120-50	N/A	N/A
Neoprene	08-1010-51	08-1020-51	08-1060-51	08-1080-51	08-1120-51	N/A	N/A
Buna-N	08-1010-52	08-1020-52	N/A	08-1080-52	08-1120-52	N/A	N/A
Norde [®]	08-1010-54	08-1020-54	08-1060-54	08-1080-54	08-1120-54	N/A	N/A
Viton [®]	08-1010-53	08-1020-53	N/A	08-1080-53	08-1120-53	N/A	N/A
Saniflex™	08-1010-56	N/A	08-1060-56	08-1080-56	08-1120-56	N/A	08-1065-56
PTFE	08-1010-55-42	N/A	N/A	08-1080-55	N/A	08-1200-55 ¹	N/A
Full Stroke PTFE	08-1040-55-42	N/A	N/A	08-1080-55	N/A	08-1200-55 ¹	N/A
Wil-Flex™	08-1010-58	N/A	N/A	08-1080-58	08-1120-58	N/A	08-1065-57
Aluminum	N/A	N/A	N/A	N/A	08-1121-01	N/A	N/A
Stainless Steel	N/A	N/A	N/A	N/A	08-1121-03	N/A	N/A
Alloy C	N/A	N/A	N/A	N/A	08-1121-04	N/A	N/A
Mild Steel	N/A	N/A	N/A	N/A	08-1121-08	N/A	N/A

¹Utilized in conjunction with metallic seat.

Backup diaphragms used with PTFE diaphragms only.

ELASTOMER KITS OPTIONS

PRO-FLO[®]

DESCRIPTION	NEOPRENE	BUNA-N	VITON [®]	EPDM
Pro-Flo [®] Metal	08-9554-51	08-9554-52	08-9554-53	08-9554-54
Pro-Flo [®] Metal (Ultra-Flex™)	08-9564-51	08-9564-52	08-9564-53	08-9564-54
DESCRIPTION	REDUCED-STROKE PTFE	WIL-FLEX™	SANIFLEX™	POLYURETHANE
Pro-Flo [®] Metal	N/A	08-9554-58	08-9554-56	08-9554-50
Pro-Flo [®] Advanced™ Metal (PTFE ¹)	08-9570-55	N/A	N/A	N/A

PRO-FLO X™

DESCRIPTION	NEOPRENE	BUNA-N	VITON [®]	EPDM
PRO-FLO X™ Metal	08-9582-51	08-9582-52	08-9582-53	08-9582-54
PRO-FLO X™ Metal (Ultra-Flex™)	08-9586-51	08-9586-52	08-9586-53	08-9586-54
DESCRIPTION	REDUCED-STROKE PTFE	WIL-FLEX™	SANIFLEX™	POLYURETHANE
PRO-FLO X™ Advanced™ Metal (PTFE ¹)	08-9588-55	N/A	N/A	N/A

¹51 mm (2") Advanced™ aluminum, stainless steel and alloy C pumps require special PTFE diaphragms (p/n 08-1010-55-42).

NOTES

NOTES

WARRANTY

Each and every product manufactured by Wilden Pump and Engineering, LLC is built to meet the highest standards of quality. Every pump is functionally tested to insure integrity of operation.

Wilden Pump and Engineering, LLC warrants that pumps, accessories and parts manufactured or supplied by it to be free from defects in material and workmanship for a period of five (5) years from date of installation or six (6) years from date of manufacture, whichever comes first. Failure due to normal wear, misapplication, or abuse is, of course, excluded from this warranty.

Since the use of Wilden pumps and parts is beyond our control, we cannot guarantee the suitability of any pump or part for a particular application and Wilden Pump and Engineering, LLC shall not be liable for any consequential damage or expense arising from the use or misuse of its products on any application. Responsibility is limited solely to replacement or repair of defective Wilden pumps and parts.

All decisions as to the cause of failure are the sole determination of Wilden Pump and Engineering, LLC.

Prior approval must be obtained from Wilden for return of any items for warranty consideration and must be accompanied by the appropriate MSDS for the product(s) involved. A Return Goods Tag, obtained from an authorized Wilden distributor, must be included with the items which must be shipped freight prepaid.

The foregoing warranty is exclusive and in lieu of all other warranties expressed or implied (whether written or oral) including all implied warranties of merchantability and fitness for any particular purpose. No distributor or other person is authorized to assume any liability or obligation for Wilden Pump and Engineering, LLC other than expressly provided herein.

PLEASE PRINT OR TYPE AND FAX TO WILDEN

PUMP INFORMATION			
Item # _____		Serial # _____	
Company Where Purchased _____			
YOUR INFORMATION			
Company Name _____			
Industry _____			
Name _____		Title _____	
Street Address _____			
City _____		State _____	Country _____
Telephone _____		Fax _____	Web Address _____
Number of pumps in facility? _____		Number of Wilden pumps? _____	
Types of pumps in facility (check all that apply): <input type="checkbox"/> Diaphragm <input type="checkbox"/> Centrifugal <input type="checkbox"/> Gear <input type="checkbox"/> Submersible <input type="checkbox"/> Lobe			
<input type="checkbox"/> Other _____			
Media being pumped? _____			
How did you hear of Wilden Pump? <input type="checkbox"/> Trade Journal <input type="checkbox"/> Trade Show <input type="checkbox"/> Internet/E-mail <input type="checkbox"/> Distributor			
<input type="checkbox"/> Other _____			

ONCE COMPLETE, FAX TO (909) 783-3440

NOTE: WARRANTY VOID IF PAGE IS NOT FAXED TO WILDEN

WILDEN PUMP & ENGINEERING, LLC

PSG® Brands

ABAQUE®
PERISTALTIC PUMPS
mouvex.com

ALMATEC®
AIR-OPERATED
DOUBLE-DIAPHRAGM PUMPS
almatec.de

AUTOMATIK
PELLETIZING SYSTEMS
maag.com

BLACKMER®
VANE PUMPS & COMPRESSORS
blackmer.com

FLUID DYNAMICS™
POLYMER BLENDING SYSTEMS
fluiddynamics1.com

GRISWOLD™
CENTRIFUGAL PUMPS
griswoldpump.com

**MAAG
FILTRATION**
PLASTIC MANUFACTURING &
PROCESSING FILTRATION
maag.com

**MAAG
INDUSTRIAL PUMPS**
GEAR & SCREW PUMPS
maag.com

**MAAG
PUMP SYSTEMS**
EXTRUSION PUMPS & SYSTEMS
maag.com

MOUVEX®
ECCENTRIC DISC PUMPS,
VANE PUMPS &
COMPRESSORS
mouvex.com

NEPTUNE™
DIAPHRAGM (METERING) PUMPS,
POLYMER SYSTEMS & MIXERS
neptune1.com

QUATTROFLOW™
QUATERNARY DIAPHRAGM
PUMP TECHNOLOGY
quattroflow.com

REDSCREW™
SCREW PUMPS
redscrewpump.com

SYSTEM ONE®
CENTRIFUGAL PUMPS
blackmer.com

WILDEN®
AIR-OPERATED
DOUBLE-DIAPHRAGM PUMPS
wildenpump.com



Where Innovation Flows

WILDEN®
Part of Pump Solutions Group
A DOVER COMPANY

22069 Van Buren St.
Grand Terrace, CA 92313-5651
T: +1 (909) 422-1731
F: +1 (909) 783-3440

PSG reserves the right to modify the information and illustrations contained in this document without prior notice. This is a non-contractual document. 06-2014

Authorized PSG Representative:

Copyright ©2014, Pump Solutions Group (PSG), A Dover Company