

PX Stallion

Original™ Series **METAL** Pumps

EOM

Engineering
Operation &
Maintenance



Simplify your process

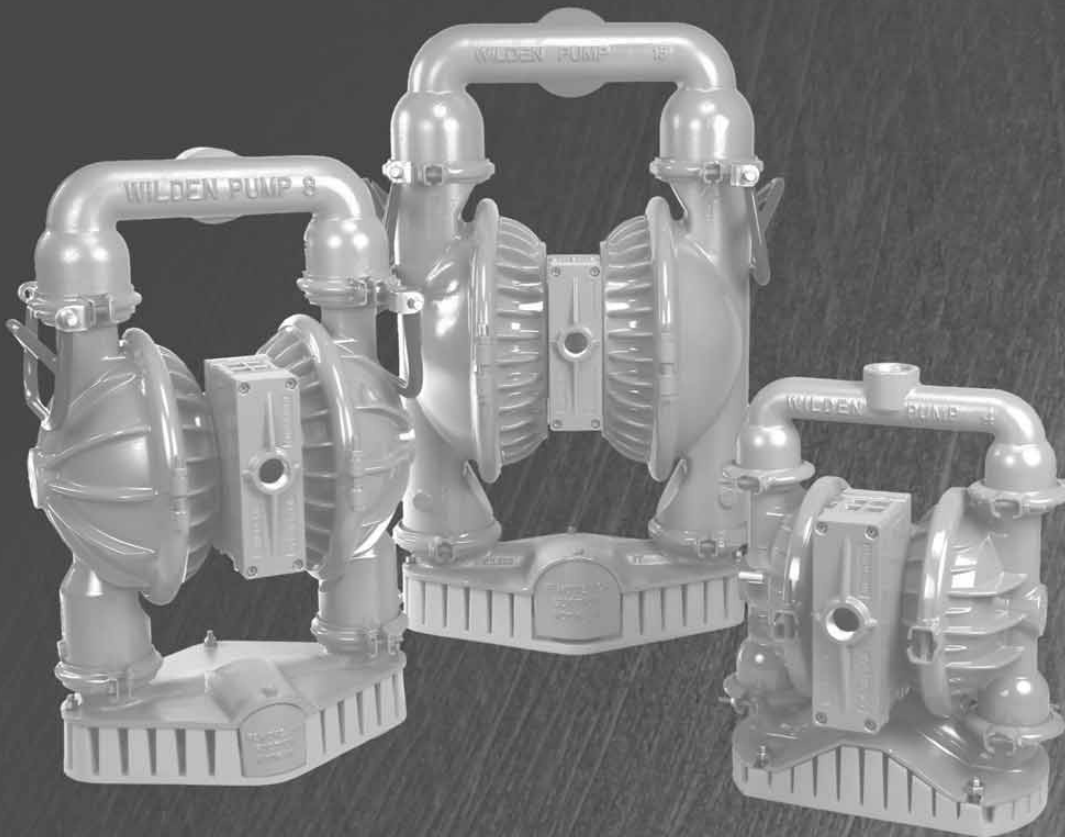

 **STALLION**[®]
SOLIDS HANDLING PUMP

PROFLO[™]
PROGRESSIVE PUMP TECHNOLOGY **X**

WILDEN

A **DOVER** COMPANY



WIL-10800-E-02
TO REPLACE WIL-10800-E-01

TABLE OF CONTENTS

SECTION 1 CAUTIONS—READ FIRST! 1

SECTION 2 WILDEN PUMP DESIGNATION SYSTEM 2

SECTION 3 HOW IT WORKS—PUMP & AIR DISTRIBUTION SYSTEM 3

SECTION 4 DIMENSIONAL DRAWINGS 4

SECTION 5 PERFORMANCE

 A. PX Stallion Performance

 Operating Principal 8

 How to Use this EMS Curve 9

 Performance Curves

 PX4 - Ultra-Flex Fitted 12

 PX8 - Ultra-Flex Fitted 13

 PX15 - Ultra-Flex Fitted 14

 B. Suction Lift Curves 15

SECTION 6 SUGGESTED INSTALLATION, OPERATION & TROUBLESHOOTING 17

SECTION 7 ASSEMBLY / DISASSEMBLY 20

 Air Valve/Center Section Disassembly 23

 Reassembly Hints & Tips 26

SECTION 8 EXPLODED VIEW & PARTS LISTING

 PX4 Stallion Metal

 Ultra-Flex™ -Fitted 28

 PX8 Stallion Metal

 Ultra-Flex™ -Fitted 30















 PX15 Stallion Metal

 Ultra-Flex™ -Fitted 32

SECTION 9 ELASTOMER OPTIONS 34



CAUTIONS—READ FIRST!

-  **CAUTION:** Do not apply compressed air to the exhaust port — pump will not function.
-  **CAUTION:** Do not, under any circumstance loosen the set screw located at the adjuster dial of the Pro-Flo X™ pump. If the set screw is loose when the pump is pressurized, it could eject and cause injury to anyone in the area.
-  **CAUTION:** Do not over-lubricate air supply — excess lubrication will reduce pump performance. Pump is pre-lubed.
-  **TEMPERATURE LIMITS:**
- | | | |
|----------|--------------------|----------------|
| Neoprene | -17.7°C to 93.3°C | 0°F to 200°F |
| Buna-N | -12.2°C to 82.2°C | 10°F to 180°F |
| Nordel® | -51.1°C to 137.8°C | -60°F to 280°F |
| Viton® | -40°C to 176.7°C | -40°F to 350°F |
- NOTE: Not all materials are available for all models. Refer to Section 2 for material options for your pump.
-  **CAUTION:** When choosing pump materials, be sure to check the temperature limits for all wetted components. Example: Viton® has a maximum limit of 176.7°C (350°F) but polypropylene has a maximum limit of only 79°C (175°F).
-  **CAUTION:** Maximum temperature limits are based upon mechanical stress only. Certain chemicals will significantly reduce maximum safe operating temperatures. Consult Chemical Resistance Guide (E4) for chemical compatibility and temperature limits.
-  **WARNING:** Prevention of static sparking — If static sparking occurs, fire or explosion could result. Pump, valves, and containers must be grounded to a proper grounding point when handling flammable fluids and whenever discharge of static electricity is a hazard.
-  **CAUTION:** Do not exceed 8.6 bar (125 psig) air supply pressure.
-  **CAUTION:** The process fluid and cleaning fluids must be chemically compatible with all wetted pump components. Consult Chemical Resistance Guide (E4).
-  **CAUTION:** Do not exceed 82°C (180°F) air inlet temperature for Pro-Flo X™ models.
-  **CAUTION:** Pumps should be thoroughly flushed before installing into process lines. FDA and USDA approved pumps should be cleaned and/or sanitized before being used.
-  **CAUTION:** Always wear safety glasses when operating pump. If diaphragm rupture occurs, material being pumped may be forced out air exhaust.
-  **CAUTION:** Before any maintenance or repair is attempted, the compressed air line to the pump should be disconnected and all air pressure allowed to bleed from pump. Disconnect all intake, discharge and air lines. Drain the pump by turning it upside down and allowing any fluid to flow into a suitable container.
-  **CAUTION:** Blow out air line for 10 to 20 seconds before attaching to pump to make sure all pipeline debris is clear. Use an in-line air filter. A 5µ (micron) air filter is recommended.
-  **NOTE:** Before starting disassembly, mark a line from each liquid chamber to its corresponding air chamber. This line will assist in proper alignment during reassembly.
-  **CAUTION:** Pro-Flo® pumps cannot be used in submersible applications. Pro-Flo X™ is available in both submersible and non-submersible options. Do not use non-submersible Pro-Flo X™ models in submersible applications. Turbo-Flo® pumps can also be used in submersible applications.
-  **CAUTION:** Tighten all hardware prior to installation.



WILDEN PUMP DESIGNATION SYSTEM

PX STALLION

LEGEND

XXX / XXXXX / XXX / XX / XX / XXXX

MODEL

VALVE SEAT

SPECIALTY CODE
(if applicable)

VALVE BALLS

DIAPHRAGMS

AIR VALVE

CENTER BLOCK

AIR CHAMBERS

WETTED PARTS & OUTER PISTON

MATERIAL CODES

MODEL

PX4 = 38 mm (1-1/2")
 PX8 = 51 mm (2")
 PX15 = 76 mm (3")

WETTED PARTS & OUTER PISTON

AA = ALUMINUM / ALUMINUM
 WW = DUCTILE IRON / DUCTILE IRON (PX4 & PX8 Only)

AIR CHAMBERS

A = ALUMINUM
 W = DUCTILE IRON (PX4 & PX8 Only)

CENTER BLOCK

A = ALUMINUM

AIR VALVE

R = ANODIZED ALUMINUM

ULTRA-FLEX™ DIAPHRAGMS

BNU = BUNA-N (Red Dot)
 EPU = NORDEL® (Blue Dot)
 NEU = NEOPRENE (Green Dot)
 VTU = VITON® (Silver or White Dot)

VALVE BALL

BN = BUNA-N (Red Dot)
 EP = NORDEL® (Blue Dot)
 NE = NEOPRENE (Green Dot)
 VT = VITON® (Silver or White Dot)

VALVE SEAT

BN = BUNA-N (Red Dot)
 EP = NORDEL® (Blue Dot)
 NE = NEOPRENE (Green Dot)
 VT = VITON® (Silver or White Dot)

SPECIALTY CODES

- 0046 Stallion internals, BSPT
- 0048 Stallion Internals
- 0050 Stallion**
- 0051 Stallion, BSPT**
- 0076 Food Processing, Stallion Internals

NOTE: Bold specialty codes indicate the standard product offering.



HOW IT WORKS—PUMP

The Wilden diaphragm pump is an air-operated, positive displacement, self-priming pump. These drawings show flow pattern through the pump upon its initial stroke. It is assumed the pump has no fluid in it prior to its initial stroke.

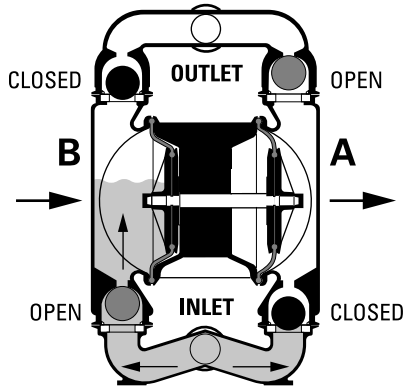

FIGURE 1 The air valve directs pressurized air to the back side of diaphragm A. The compressed air is applied directly to the liquid column separated by elastomeric diaphragms. The diaphragm acts as a separation membrane between the compressed air and liquid, balancing the load and removing mechanical stress from the diaphragm. The compressed air moves the diaphragm away from the center of the pump. The opposite diaphragm is pulled in by the shaft connected to the pressurized diaphragm. Diaphragm B is on its suction stroke; air behind the diaphragm has been forced out to atmosphere through the exhaust port of the pump. The movement of diaphragm B toward the center of the pump creates a vacuum within chamber B. Atmospheric pressure forces fluid into the inlet manifold forcing the inlet valve ball off its seat. Liquid is free to move past the inlet valve ball and fill the liquid chamber (see shaded area).

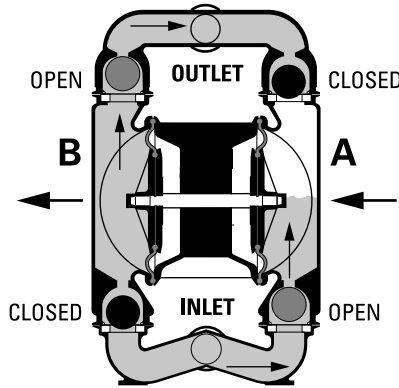

FIGURE 2 When the pressurized diaphragm, diaphragm A, reaches the limit of its discharge stroke, the air valve redirects pressurized air to the back side of diaphragm B. The pressurized air forces diaphragm B away from the center while pulling diaphragm A to the center. Diaphragm B is now on its discharge stroke. Diaphragm B forces the inlet valve ball onto its seat due to the hydraulic forces developed in the liquid chamber and manifold of the pump. These same hydraulic forces lift the discharge valve ball off its seat, forcing fluid to flow through the pump discharge. The movement of diaphragm A toward the center of the pump creates a vacuum within liquid chamber A. Atmospheric pressure forces fluid into the inlet manifold of the pump. The inlet valve ball is forced off its seat allowing the fluid being pumped to fill the liquid chamber.

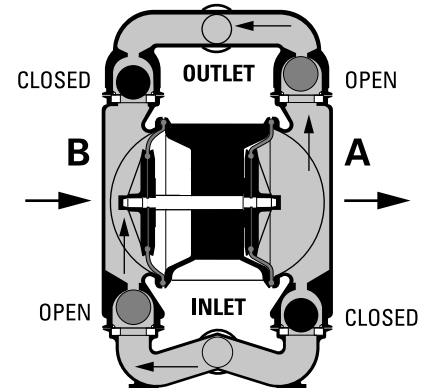
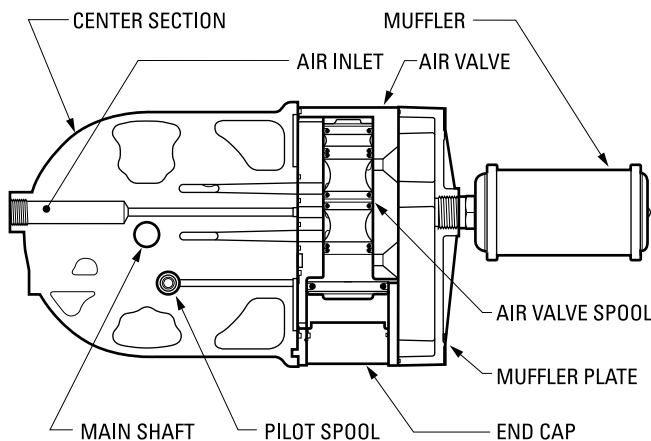

FIGURE 3 At completion of the stroke, the air valve again redirects air to the back side of diaphragm A, which starts diaphragm B on its exhaust stroke. As the pump reaches its original starting point, each diaphragm has gone through one exhaust and one discharge stroke. This constitutes one complete pumping cycle. The pump may take several cycles to completely prime depending on the conditions of the application.



HOW IT WORKS—AIR DISTRIBUTION SYSTEM



The Pro-Flo[®] patented air distribution system incorporates two moving parts: the air valve spool and the pilot spool. The heart of the system is the air valve spool and air valve. This valve design incorporates an unbalanced spool. The smaller end of the spool is pressurized continuously, while the large end is alternately pressurized then exhausted to move the spool. The spool directs pressurized air to one air chamber while exhausting the other. The air causes the main shaft/diaphragm assembly to shift to one side — discharging liquid on that side and pulling liquid in on the other side. When the shaft reaches the end of its stroke, the inner piston actuates the pilot spool, which pressurizes and exhausts the large end of the air valve spool. The repositioning of the air valve spool routes the air to the other air chamber.

PX4 Stallion

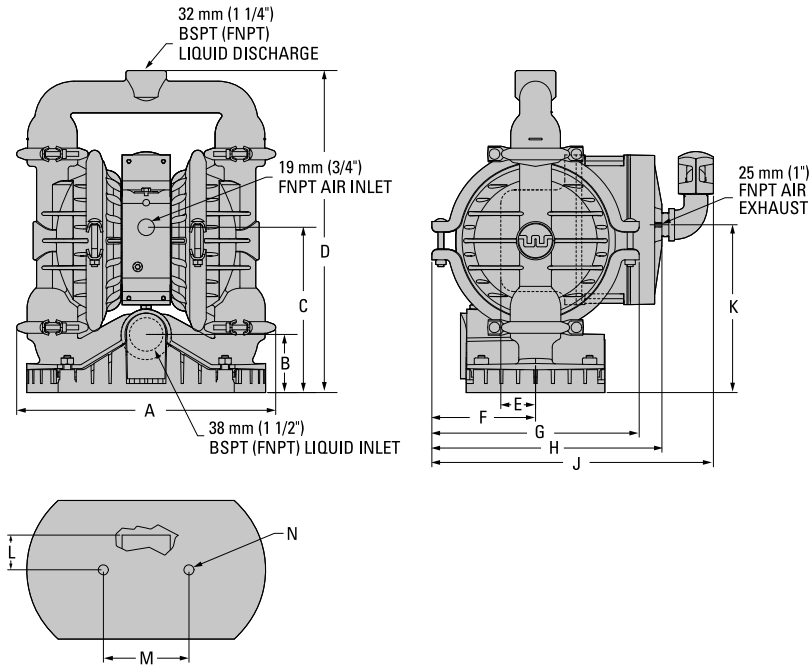

DIMENSIONS

ITEM	METRIC (mm)	STANDARD (inch)
A	366	14.4
B	81	3.2
C	234	9.2
D	455	17.9
E	48	1.9
F	147	5.8
G	292	11.5
H	325	12.8
J	396	15.6
K	236	9.3
L	48	1.9
M	122	4.8
N	15 DIA	.6 DIA

PX8 Stallion

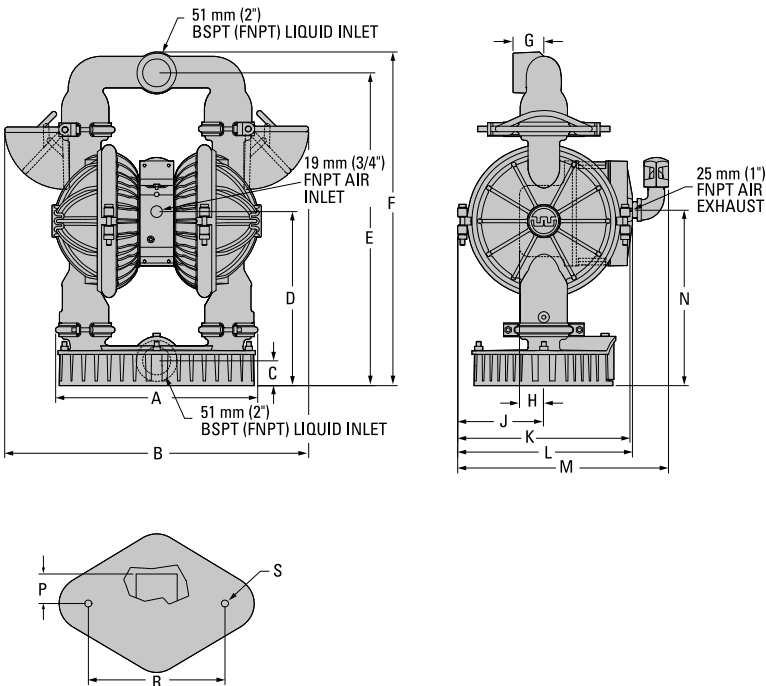

DIMENSIONS

ITEM	METRIC (mm)	STANDARD (inch)
A	406	16.0
B	612	24.1
C	51	2.0
D	351	13.8
E	630	24.8
F	671	26.4
G	61	2.4
H	48	1.9
J	173	6.8
K	345	13.6
L	351	13.8
M	424	16.7
N	353	13.9
P	58	2.3
R	274	10.8
S	15 DIA	.6 DIA

PX15 Stallion

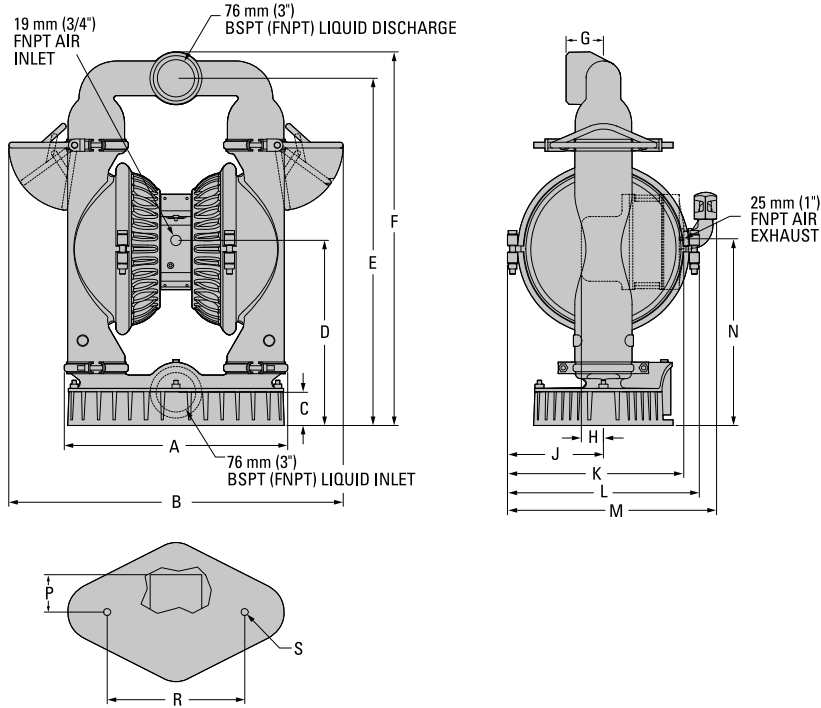

DIMENSIONS

ITEM	METRIC (mm)	STANDARD (inch)
A	495	19.5
B	742	29.2
C	74	2.9
D	411	16.2
E	770	30.3
F	828	32.6
G	84	3.3
H	48	1.9
J	213	8.4
K	391	15.4
L	424	16.7
M	462	18.2
N	414	16.3
P	84	3.3
R	305	12.0
S	15 DIA	.6 DIA

Finding A Spares Nightmare

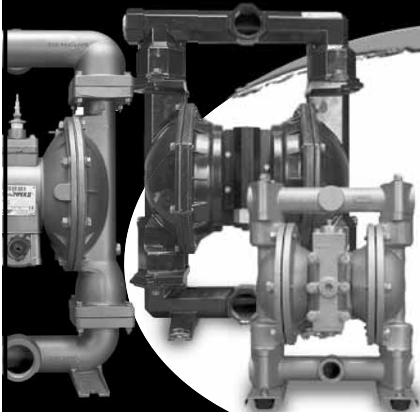

PRODUCTS: AODDP

(Air Operated Double Diaphragm Pumps)

- Warren-Rupp®
- ARO®
- Other



PUMP PARTS

(Low Cost)

- Diaphragms
- Valve balls
- Valve seats



KNOWLEDGE & SERVICE

- Competitive pricing
- Delivery
- Service
- Inventory

Sleep easier with



Spectrom is not your typical after market part supplier. We do not simply sell pump parts; we provide value added procurement solutions.

Our unique network enables us to purchase effectively, resulting in low cost solutions. We also know that low purchase price is not enough - quality, integrity and inventory are also important. Spectrom is structured to provide Pre and Post sales support, giving our customers value added application and pump knowledge.

Contact us to have a procurement solution developed for you. We don't just fit you into a generic system, we develop specific solutions that achieve results.

Spectrom will ship your order from our facility within 3 working days!

WARNING: These parts may exhibit better life than OEM parts.



1-909-512-1261 www.spectromparts.com

PX

STALLION

WILDEN®
A DOVER COMPANY



PX STALLION



Pro-Flo X™ Operating Principal

The Pro-Flo X™ air distribution system with the revolutionary Efficiency Management System (EMS) offers flexibility never before seen in the world of AODD pumps. The patent-pending EMS is simple and easy to use. With the turn of an integrated

control dial, the operator can select the optimal balance of flow and efficiency that best meets the application needs. Pro-Flo X™ provides higher

performance, lower operational costs and flexibility that exceeds previous industry standards.



<p>Turning the dial changes the relationship between air inlet and exhaust porting.</p>	<p>Each dial setting represents an entirely different flow curve</p>	<p>Pro-Flo X™ pumps are shipped from the factory on setting 4, which is the highest flow rate setting possible</p>	<p>Moving the dial from setting 4 causes a decrease in flow and an even greater decrease in air consumption.</p>	<p>When the air consumption decreases more than the flow rate, efficiency is improved and operating costs are reduced.</p>

Example 1

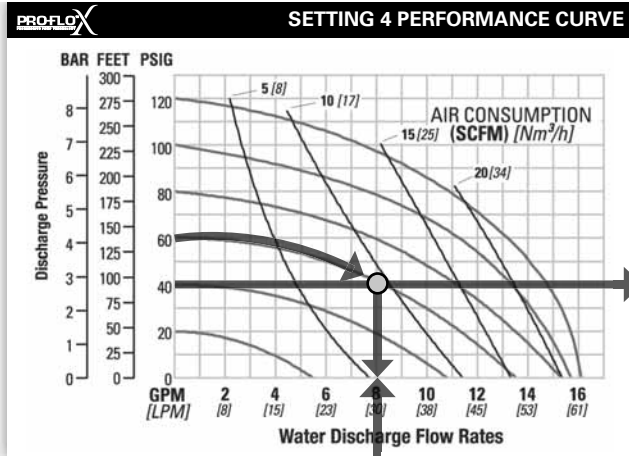

Figure 1

Example data point = **8.2** GPM

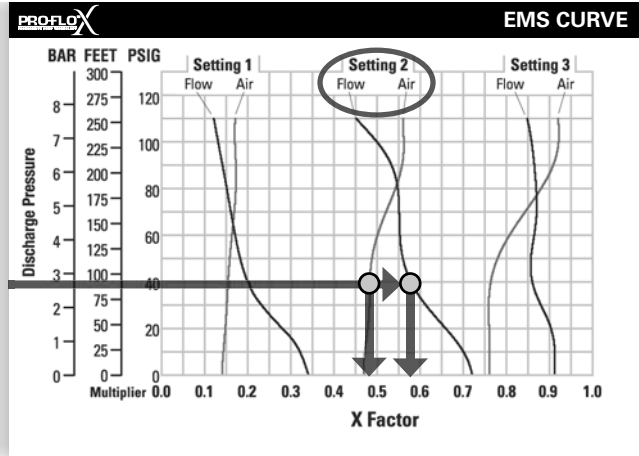

Figure 2

Example data point = **0.58** flow multiplier
0.48 air multiplier

This is an example showing how to determine flow rate and air consumption for your Pro-Flo X™ pump using the Efficiency Management System (EMS) curve and the performance curve. For this example we will be using 4.1 bar (60 psig) inlet air pressure and 2.8 bar (40 psig) discharge pressure and EMS setting 2.

Step 1: Identifying performance at setting 4. Locate the curve that represents the flow rate of the pump with 4.1 bar (60 psig) air inlet pressure. Mark the point where this curve crosses the horizontal line representing 2.8 bar (40 psig) discharge pressure. (Figure 1). After locating your performance point on the flow curve, draw a vertical line downward until reaching the bottom scale on the chart. Identify the flow rate (in this case, 8.2 gpm). Observe location of performance point relative to air consumption curves and approximate air consumption value (in this case, 9.8 scfm).

Step 2: Determining flow and air X Factors. Locate your discharge pressure (40 psig) on the vertical axis of the EMS curve (Figure 2). Follow along the 2.8 bar (40 psig) horizontal line until intersecting both flow and air curves for your desired EMS setting (in this case, setting 2). Mark the points where the EMS curves intersect the horizontal discharge pressure line. After locating your EMS points on the EMS

curve, draw vertical lines downward until reaching the bottom scale on the chart. This identifies the flow X Factor (in this case, 0.58) and air X Factor (in this case, 0.48).

Step 3: Calculating performance for specific EMS setting. Multiply the flow rate (8.2 gpm) obtained in Step 1 by the flow X Factor multiplier (0.58) in Step 2 to determine the flow rate at EMS setting 2. Multiply the air consumption (9.8 scfm) obtained in Step 1 by the air X Factor multiplier (0.48) in Step 2 to determine the air consumption at EMS setting 2 (Figure 3).

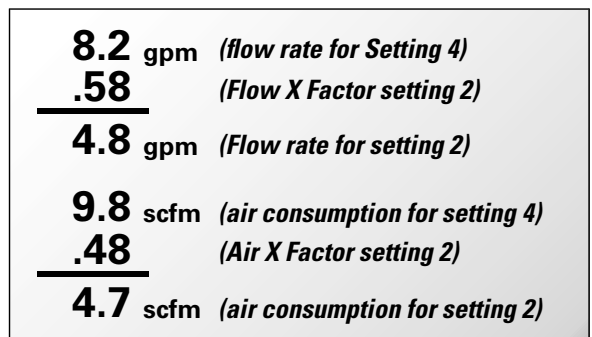

Figure 3

The flow rate and air consumption at Setting 2 are found to be 18.2 lpm (4.8 gpm) and 7.9 Nm³/h (4.7 scfm) respectively.

Example 2.1

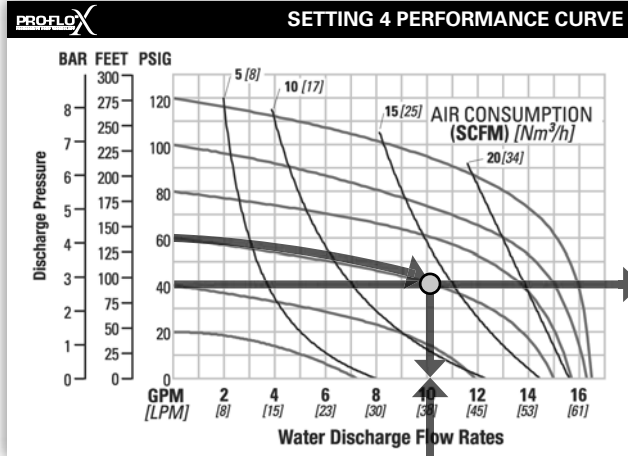

Figure 4

Example data point = **10.2** gpm

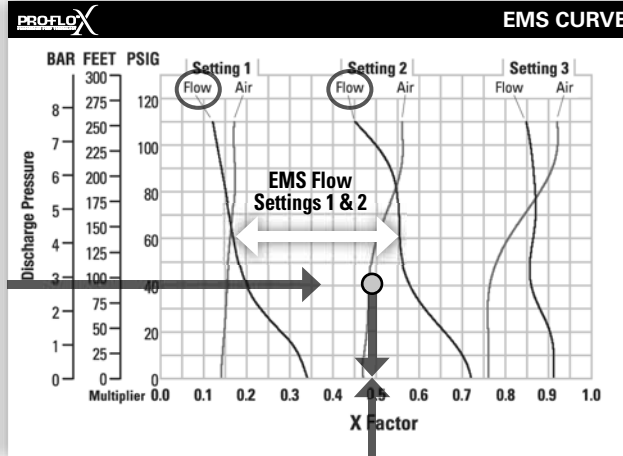

Figure 5

0.49 flow multiplier

This is an example showing how to determine the inlet air pressure and the EMS setting for your Pro-Flo X™ pump to optimize the pump for a specific application. For this example we will be using an application requirement of 18.9 lpm (5 gpm) flow rate against 2.8 bar (40 psig) discharge pressure. This example will illustrate how to calculate the air consumption that could be expected at this operational point.

DETERMINE EMS SETTING

Step 1: Establish inlet air pressure. Higher air pressures will typically allow the pump to run more efficiently, however, available plant air pressure can vary greatly. If an operating pressure of 6.9 bar (100 psig) is chosen when plant air frequently dips to 6.2 bar (90 psig) pump performance will vary. Choose an operating pressure that is within your compressed air system's capabilities. For this example we will choose 4.1 bar (60 psig).

Step 2: Determine performance point at setting 4. For this example an inlet air pressure of 4.1 bar (60 psig) inlet air pressure has been chosen. Locate the curve that represents the performance of the pump with 4.1 bar (60 psig) inlet air pressure. Mark the point where this curve crosses the horizontal line representing 2.8 bar (40 psig) discharge pressure. After locating this point on the flow curve, draw a vertical line downward until reaching the bottom scale on the chart and identify the flow rate.

In our example it is 38.6 lpm (10.2 gpm). This is the setting 4 flow rate. Observe the location of the performance point relative to air consumption curves and approximate air consumption value. In our example setting 4 air consumption is 24 Nm³/h (14 scfm). See figure 4.

Step 3: Determine flow X Factor. Divide the required flow rate 18.9 lpm (5 gpm) by the setting 4 flow rate 38.6 lpm (10.2 gpm) to determine the flow X Factor for the application.

$$5 \text{ gpm} / 10.2 \text{ gpm} = 0.49 \text{ (flow X Factor)}$$

Step 4: Determine EMS setting from the flow X Factor. Plot the point representing the flow X Factor (0.49) and the application discharge pressure 2.8 bar (40 psig) on the EMS curve. This is done by following the horizontal 2.8 bar (40 psig) psig discharge pressure line until it crosses the vertical 0.49 X Factor line. Typically, this point lies between two flow EMS setting curves (in this case, the point lies between the flow curves for EMS setting 1 and 2). Observe the location of the point relative to the two curves it lies between and approximate the EMS setting (figure 5). For more precise results you can mathematically interpolate between the two curves to determine the optimal EMS setting.

For this example the EMS setting is 1.8.

Example 2.2

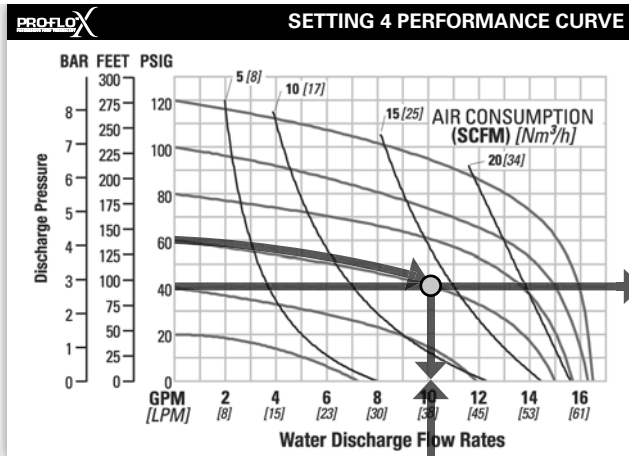

Figure 6

Example data point = **10.2** gpm

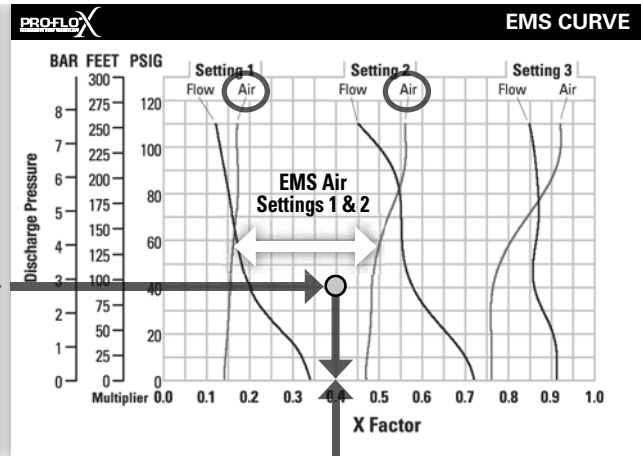

Figure 7

Example data point = **0.40** air multiplier

Determine air consumption at a specific EMS setting.

Step 1: Determine air X Factor. In order to determine the air X Factor, identify the two air EMS setting curves closest to the EMS setting established in example 2.1 (in this case, the point lies between the air curves for EMS setting 1 and 2). The point representing your EMS setting (1.8) must be approximated and plotted on the EMS curve along the horizontal line representing your discharge pressure (in this case, 40 psig). This air point is different than the flow point plotted in example 2.1. After estimating (or interpolating) this point on the curve, draw a vertical line downward until reaching the bottom scale on the chart and identify the air X Factor (figure 7).

For this example the air X Factor is **0.40**

Step 2: Determine air consumption. Multiply your setting 4 air consumption (14 scfm) value by the air X Factor obtained above (0.40) to determine your actual air consumption.

$$14 \text{ scfm} \times 0.40 = 5.6 \text{ SCFM}$$

In summary, for an application requiring 18.9 lpm (5 gpm) against 2.8 bar (40 psig) discharge pressure, the pump inlet air pressure should be set to 4.1 bar (60 psig) and the EMS dial should be set to 1.8. The pump would then consume 9.5 Nm³/h (5.6 scfm) of compressed air.

PX4 Stallion, Metal Ultra-Flex Fitted



PERFORMANCE



SETTING 4 PERFORMANCE CURVE

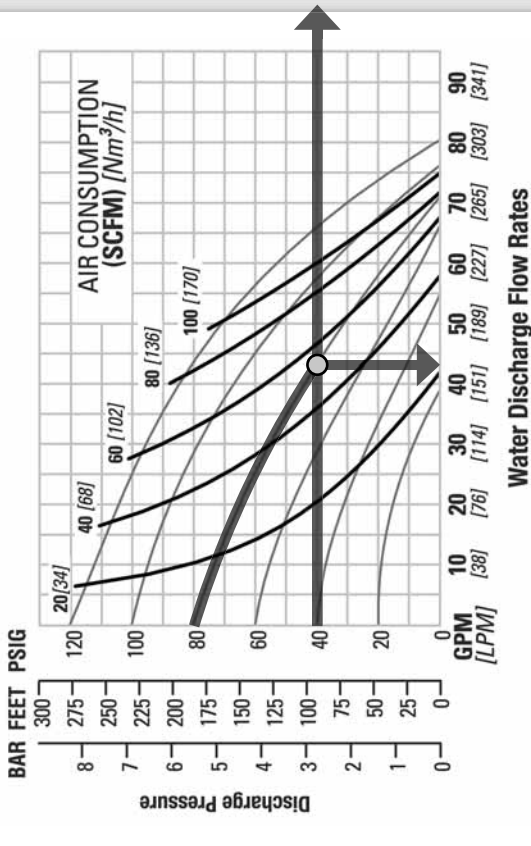

EMS CURVE

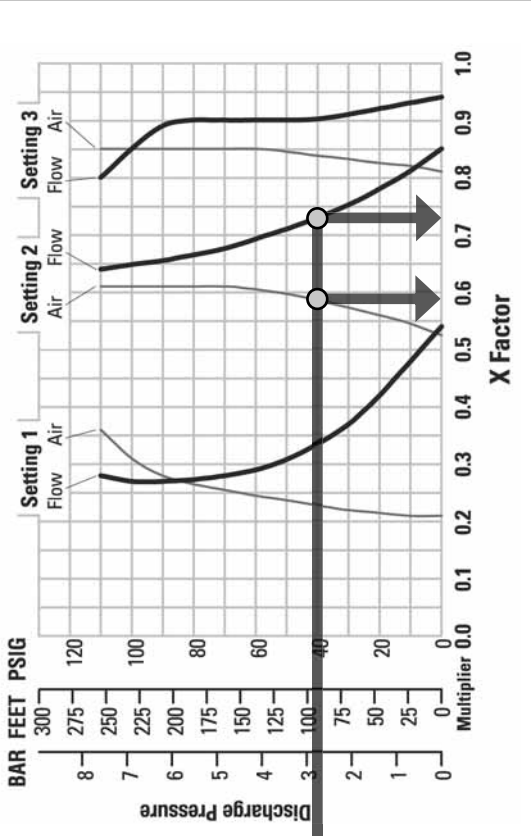

TECHNICAL DATA

Height	454 mm (17.9")
Width	365 mm (14.4")
Depth	396 mm (15.6")
Ship Weight	Aluminum 22 kg (49 lbs.) Ductile Iron 30 kg (66 lbs.)
Air Inlet	19 mm (3/4")
Inlet	38 mm (1-1/2")
Outlet	38 mm (1-1/2")
Suction Lift	6.4 m Dry (21.0') 9.2 m Wet (30.1')
Disp. Per Stroke	72 l (0.19 gal.) ¹
Max. Flow Rate	305 lpm (81 gpm)
Max. Size Solids	13 mm (1/2")

¹Displacement per stroke was calculated at 4.8 bar (70 psig) air inlet pressure against a 2 bar (30 psig) head pressure.

EXAMPLE

The Efficiency Management System (EMS) can be used to optimize the performance of your Wilden pump for specific applications. The pump is delivered with the EMS adjusted to setting 4, which allows maximum flow.

The EMS curve allows the pump user to determine flow and air consumption at each EMS setting. For any EMS setting and discharge pressure, the "X factor" is used as a multiplier with the original values from the setting 4 performance curve to calculate the actual flow and air consumption values for that specific EMS setting. Note: you can interpolate between the setting curves for operation at intermediate EMS settings.

A PX4 Aluminum, Stallion Ultra-Flex-fitted pump operating at EMS setting 4, achieved a flow rate of 163 lpm (43 gpm) using 92 Nm³/h (54 scfm) of air when run at 5.5 bar (80 psig) air inlet pressure and 2.8 bar (40 psig) discharge pressure (See dot on performance curve).

The end user did not require that much flow and wanted to reduce air consumption at his facility. He determined that EMS setting 2 would meet his needs. At 2.8 bar (40 psig) discharge pressure and EMS setting 2, the flow "X factor" is 0.73 and the air "X factor" is 0.58 (see dots on EMS curve).

Multiplying the original setting 4 values by the "X factors" provides the setting 2 flow rate of 119 lpm (31 gpm) and an air consumption of 53 Nm³/h (31 scfm). The flow rate was reduced by 27% while the air consumption was reduced by 42%, thus providing increased efficiency.

For a detailed example for how to set your EMS, see beginning of performance curve section.

Caution: Do not exceed 8.6 bar (125 psig) air supply pressure.

PX8 Stallion, Metal Ultra-Flex Fitted

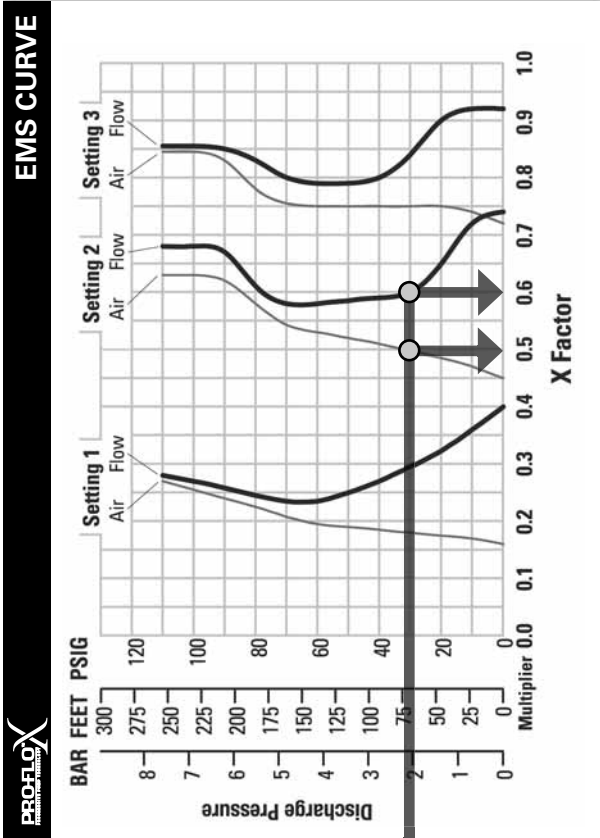
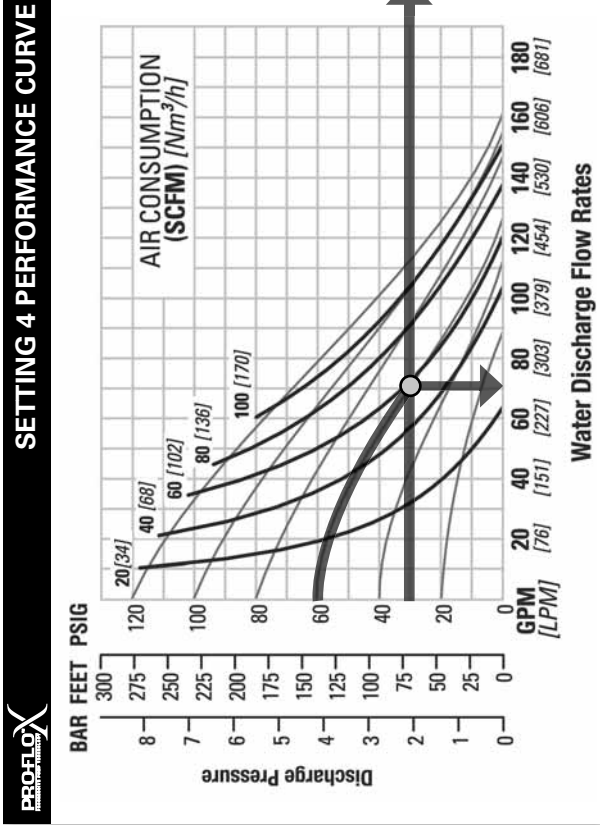

TECHNICAL DATA

Height 671 mm (26.4")
Width 612 mm (24.1")
Depth 424 mm (16.7")
Ship Weight Aluminum 36 kg (79 lbs.) Ductile Iron 49 kg (109 lbs.)
Air Inlet 19 mm (3/4")
Inlet 51 mm (2")
Outlet 51 mm (2")
Suction Lift 5.7 m Dry (18.6') 9.2 m Wet (30.1')
Disp. Per Stroke 2.0 l (0.53 gal.) ¹
Max. Flow Rate 609 lpm (161 gpm)
Max. Size Solids 19 mm (3/4")

¹Displacement per stroke was calculated at 4.8 bar (70 psig) air inlet pressure against a 2 bar (30 psig) head pressure.

The Efficiency Management System (EMS) can be used to optimize the performance of your Wilden pump for specific applications. The pump is delivered with the EMS adjusted to setting 4, which allows maximum flow.

The EMS curve allows the pump user to determine flow and air consumption at each EMS setting. For any EMS setting and discharge pressure, the "X factor" is used as a multiplier with the original values from the setting 4 performance curve to calculate the actual flow and air consumption values for that specific EMS setting. Note: you can interpolate between the setting curves for operation at intermediate EMS settings.

EXAMPLE

A PX8 Aluminum, Stallion Ultra-Flex-fitted pump operating at EMS setting 4, achieved a flow rate of 269 lpm (71 gpm) using 97 Nm³/h (57 scfm) of air when run at 4.1 bar (60 psig) air inlet pressure and 2.1 bar (30 psig) discharge pressure (See dot on performance curve).

The end user did not require that much flow and wanted to reduce air consumption at his facility. He determined that EMS setting 2 would meet his needs. At 2.1 bar (30 psig) discharge pressure and EMS setting 2, the flow "X factor" is 0.60 and the air "X factor" is 0.49 (see dots on EMS curve).

Multiplying the original setting 4 values by the "X factors" provides the setting 2 flow rate of 161 lpm (43 gpm) and an air consumption of 47 Nm³/h (28 scfm). The flow rate was reduced by 40% while the air consumption was reduced by 51%, thus providing increased efficiency.

For a detailed example for how to set your EMS, see beginning of performance curve section.

Caution: Do not exceed 8.6 bar (125 psig) air supply pressure.

PX15 Stallion, Metal Ultra-Flex Fitted



PERFORMANCE



SETTING 4 PERFORMANCE CURVE

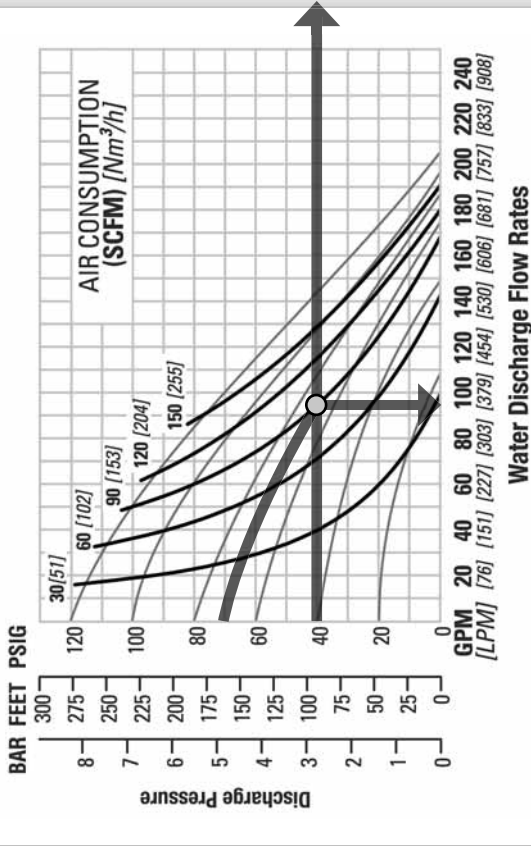

EMS CURVE

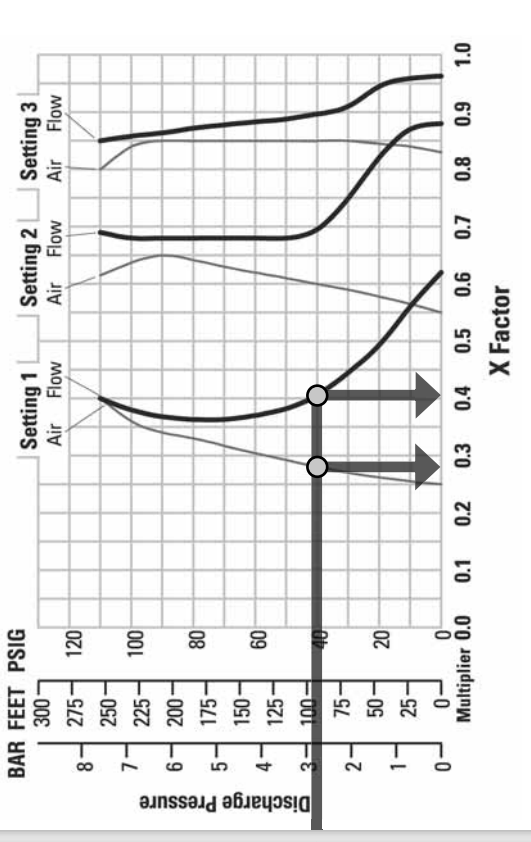

TECHNICAL DATA

Height	828 mm (32.6")
Width	742 mm (29.2")
Depth	462 mm (18.2")
Ship Weight	63 kg (138 lbs.)
Air Inlet	19 mm (3/4")
Inlet	76 mm (3")
Outlet	76 mm (3")
Suction Lift	5.7 m Dry (18.7')
	9.2 m Wet (30.1')
Disp. Per Stroke	4.3 l (1.13 gal.)
Max. Flow Rate	776 lpm (205 gpm)
Max. Size Solids	.25 mm (1")

¹Displacement per stroke was calculated at 4.8 bar (70 psig) air inlet pressure against a 2 bar (30 psig) head pressure.

The Efficiency Management System (EMS) can be used to optimize the performance of your Wilden pump for specific applications. The pump is delivered with the EMS adjusted to setting 4, which allows maximum flow.

The EMS curve allows the pump user to determine flow and air consumption at each EMS setting. For any EMS setting and discharge pressure, the "X factor" is used as a multiplier with the original values from the setting 4 performance curve to calculate the actual flow and air consumption values for that specific EMS setting. Note: you can interpolate between the setting curves for operation at intermediate EMS settings.

EXAMPLE

A PX15 Aluminum, Stallion Ultra-Flex-fitted pump operating at EMS setting 4, achieved a flow rate of 356 lpm (94 gpm) using 153 Nm³/h (90 scfm) of air when run at 4.8 bar (70 psig) air inlet pressure and 2.8 bar (40 psig) discharge pressure (See dot on performance curve).

The end user did not require that much flow and wanted to reduce air consumption at his facility. He determined that EMS setting 1 would meet his needs. At 2.8 bar (40 psig) discharge pressure and EMS setting 1, the flow "X factor" is 0.41 and the air "X factor" is 0.28 (see dots on EMS curve).

Multiplying the original setting 4 values by the "X factors" provides the setting 1 flow rate of 146 lpm (39 gpm) and an air consumption of 43 Nm³/h (25 scfm). The flow rate was reduced by 59% while the air consumption was reduced by 72%, thus providing increased efficiency.

For a detailed example for how to set your EMS, see beginning of performance curve section.

Caution: Do not exceed 8.6 bar (125 psig) air supply pressure.



SUCTION LIFT CURVES

**PX4 Stallion
METAL SUCTION
LIFT CAPABILITY**

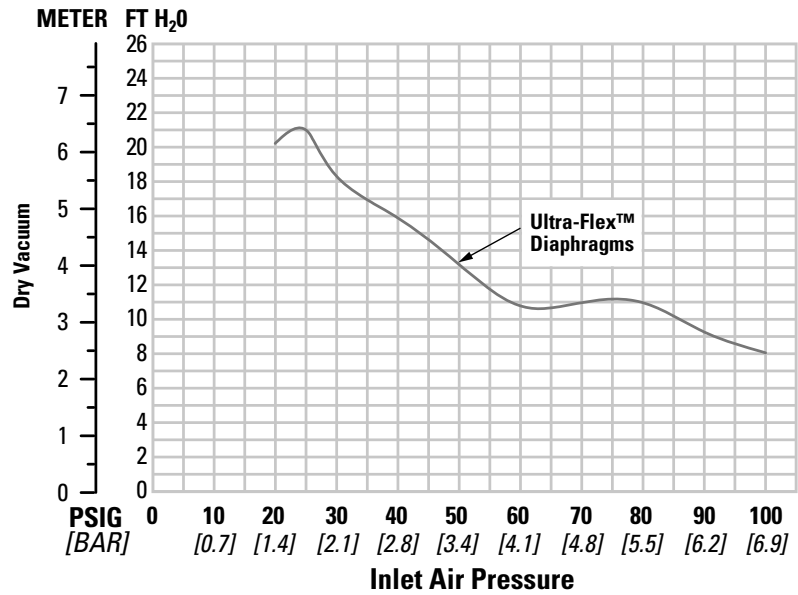

**PX8 Stallion
METAL SUCTION
LIFT CAPABILITY**

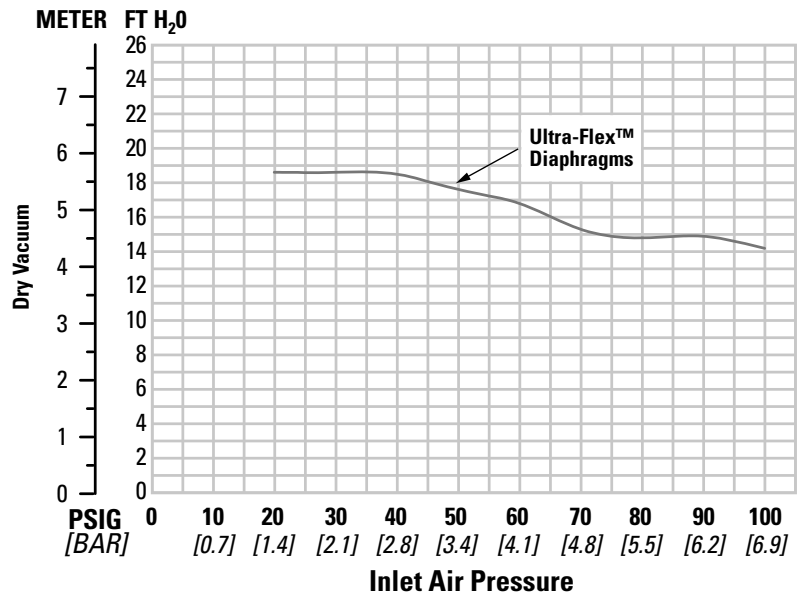

Suction lift curves are calibrated for pumps operating at 305 m (1,000') above sea level. This chart is meant to be a guide only. There are many variables which can affect your pump's operating characteristics. The

number of intake and discharge elbows, viscosity of pumping fluid, elevation (atmospheric pressure) and pipe friction loss all affect the amount of suction lift your pump will attain.

SUCTION LIFT CURVES

**PX15 Stallion
METAL SUCTION
LIFT CAPABILITY**

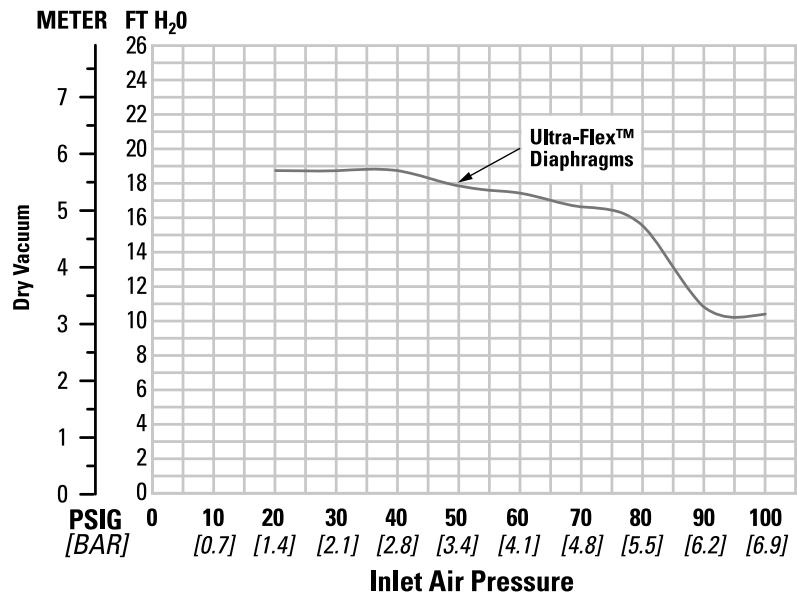

SUGGESTED INSTALLATION

Wilden pumps are designed to meet the performance requirements of even the most demanding pumping applications. They have been designed and manufactured to the highest standards and are available in a variety of liquid path materials to meet your chemical resistance needs. Refer to the performance section of this manual for an in-depth analysis of the performance characteristics of your pump. Wilden offers the widest variety of elastomer options in the industry to satisfy temperature, chemical compatibility, abrasion resistance and flex concerns.

The suction pipe size should be at least the equivalent or larger than the diameter size of the suction inlet on your Wilden pump. The suction hose must be non-collapsible, reinforced type as these pumps are capable of pulling a high vacuum. Discharge piping should also be the equivalent or larger than the diameter of the pump discharge which will help reduce friction losses. It is critical that all fittings and connections are airtight or a reduction or loss of pump suction capability will result.

INSTALLATION: Months of careful planning, study, and selection efforts can result in unsatisfactory pump performance if installation details are left to chance.

Premature failure and long term dissatisfaction can be avoided if reasonable care is exercised throughout the installation process.

LOCATION: Noise, safety, and other logistical factors usually dictate where equipment will be situated on the production floor. Multiple installations with conflicting requirements can result in congestion of utility areas, leaving few choices for additional pumps.

Within the framework of these and other existing conditions, every pump should be located in such a way that six key factors are balanced against each other to maximum advantage.

ACCESS: First of all, the location should be accessible. If it's easy to reach the pump, maintenance personnel will have an easier time carrying out routine inspections and adjustments. Should major repairs become necessary, ease of access can play a key role in speeding the repair process and reducing total downtime.

AIR SUPPLY: Every pump location should have an air line large enough to supply the volume of air necessary to achieve the desired pumping rate. Use air pressure up to a maximum of 8.6 bar (125 psig) depending on pumping requirements.

For best results, the pumps should use a 5 μ (micron) air filter, needle valve and regulator. The use of an air filter before the pump will ensure that the majority of any pipeline contaminants will be eliminated.

SOLENOID OPERATION: When operation is controlled by a solenoid valve in the air line, three-way valves should be used. This valve allows trapped air between the valve and the pump to bleed off which improves pump performance. Pumping volume can be estimated by counting the number of strokes per minute and then multiplying the figure by the displacement per stroke.

MUFFLER: Sound levels are reduced below OSHA specifications using the standard Wilden muffler. Other

mufflers can be used to further reduce sound levels, but they usually reduce pump performance.

ELEVATION: Selecting a site that is well within the pump's dynamic lift capability will assure that loss-of-prime issues will be eliminated. In addition, pump efficiency can be adversely affected if proper attention is not given to site location.

PIPING: Final determination of the pump site should not be made until the piping challenges of each possible location have been evaluated. The impact of current and future installations should be considered ahead of time to make sure that inadvertent restrictions are not created for any remaining sites.

The best choice possible will be a site involving the shortest and straightest hook-up of suction and discharge piping. Unnecessary elbows, bends, and fittings should be avoided. Pipe sizes should be selected to keep friction losses within practical limits. All piping should be supported independently of the pump. In addition, the piping should be aligned to avoid placing stress on the pump fittings.

Flexible hose can be installed to aid in absorbing the forces created by the natural reciprocating action of the pump. If the pump is to be bolted down to a solid location, a mounting pad placed between the pump and the foundation will assist in minimizing pump vibration. Flexible connections between the pump and rigid piping will also assist in minimizing pump vibration. If quick-closing valves are installed at any point in the discharge system, or if pulsation within a system becomes a problem, a surge suppressor (SD Equalizer[®]) should be installed to protect the pump, piping and gauges from surges and water hammer.

If the pump is to be used in a self-priming application, make sure that all connections are airtight and that the suction lift is within the model's ability. Note: Materials of construction and elastomer material have an effect on suction lift parameters. Please refer to the performance section for specifics.

When pumps are installed in applications involving flooded suction or suction head pressures, a gate valve should be installed in the suction line to permit closing of the line for pump service.

Pumps in service with a positive suction head are most efficient when inlet pressure is limited to 0.5–0.7 bar (7–10 psig). Premature diaphragm failure may occur if positive suction is 0.7 bar (10 psig) and higher.

SUBMERSIBLE APPLICATIONS: Pro-Flo X[™] pumps can be used for submersible applications, when using the Pro-Flo X[™] submersible option. Turbo-Flo[™] pumps can also be used for submersible applications.

NOTE: Pro-Flo[®] and Accu-Flo[™] pumps are not submersible.

ALL WILDEN PUMPS ARE CAPABLE OF PASSING SOLIDS. A STRAINER SHOULD BE USED ON THE PUMP INTAKE TO ENSURE THAT THE PUMP'S RATED SOLIDS CAPACITY IS NOT EXCEEDED.

CAUTION: DO NOT EXCEED 8.6 BAR (125 PSIG) AIR SUPPLY PRESSURE.

SUGGESTED INSTALLATION

This illustration is a generic representation of an air-operated double-diaphragm pump.

EXAMPLE 1

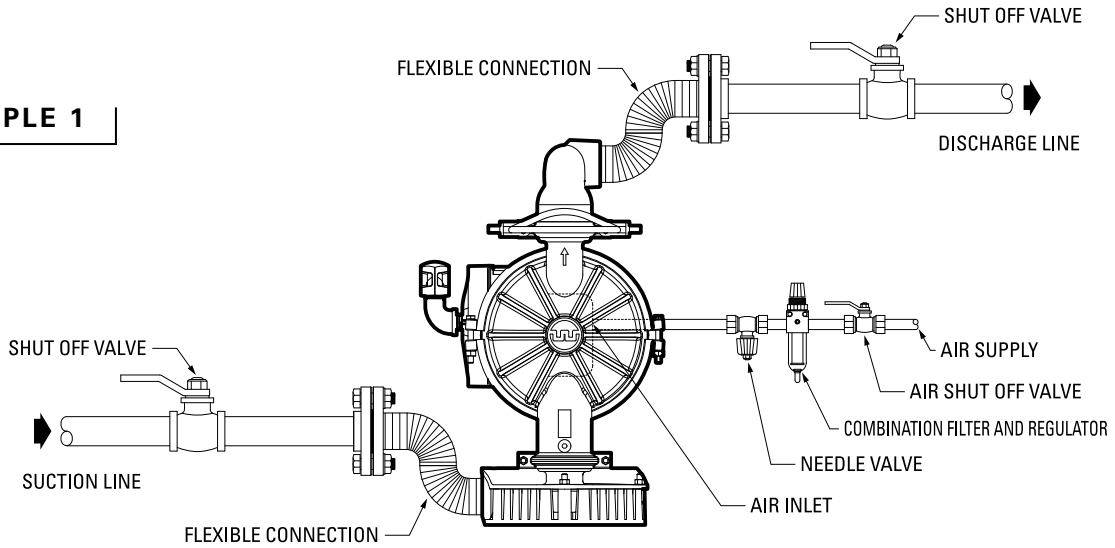

EXAMPLE 2

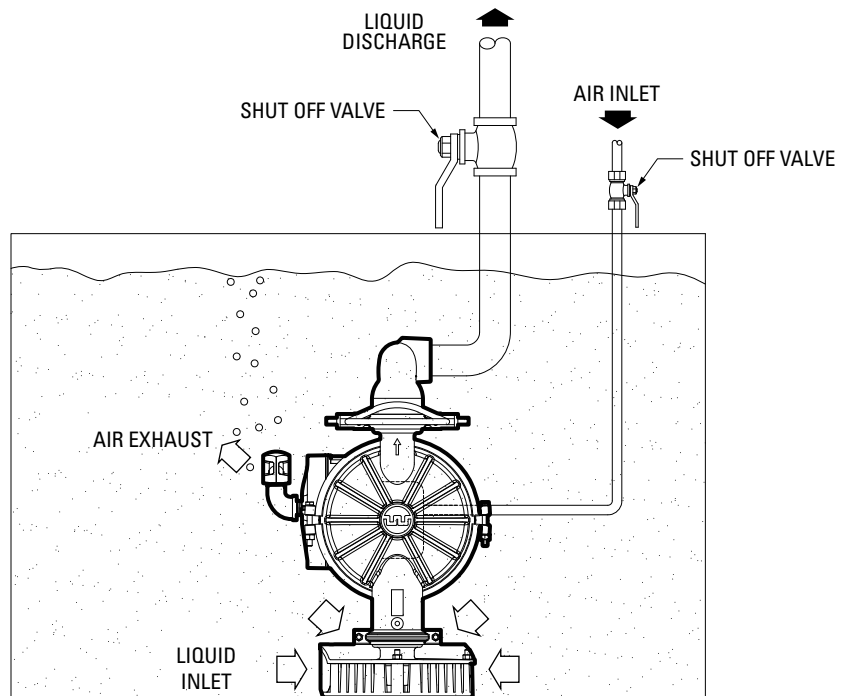

NOTE: In the event of a power failure, the shut off valve should be closed, if the restarting of the pump is not desirable once power is regained.

AIR OPERATED PUMPS: To stop the pump from operating in an emergency situation, simply close the

shut off valve (user supplied) installed in the air supply line. A properly functioning valve will stop the air supply to the pump, therefore stopping output. This shut off valve should be located far enough away from the pumping equipment such that it can be reached safely in an emergency situation.

SUGGESTED OPERATION & MAINTENANCE

OPERATION: PX pumps are pre-lubricated, and do not require in-line lubrication. Additional lubrication will not damage the pump, however if the pump is heavily lubricated by an external source, the pump's internal lubrication may be washed away. If the pump is then moved to a non-lubricated location, it may need to be disassembled and re-lubricated as described in the ASSEMBLY/DISASSEMBLY INSTRUCTIONS.

Pump discharge rate can be controlled by limiting the volume and/or pressure of the air supply to the pump. An air regulator is used to regulate air pressure. A needle valve is used to regulate volume. Pump discharge rate can also be controlled by throttling the pump discharge by partially closing a valve in the discharge line of the pump. This action increases friction loss which reduces flow rate. (See Section 5.) This is useful when the need exists to control the pump from a remote location. When the pump discharge pressure equals or exceeds the air supply pressure, the pump will stop; no bypass or pressure relief valve is needed, and pump damage will not occur. The pump has reached a "deadhead" situation and can be restarted by reducing the fluid

discharge pressure or increasing the air inlet pressure. The Wilden PX pumps run solely on compressed air and do not generate heat, therefore your process fluid temperature will not be affected.

MAINTENANCE AND INSPECTIONS: Since each application is unique, maintenance schedules may be different for every pump. Frequency of use, line pressure, viscosity and abrasiveness of process fluid all affect the parts life of a Wilden pump. Periodic inspections have been found to offer the best means for preventing unscheduled pump downtime. Personnel familiar with the pump's construction and service should be informed of any abnormalities that are detected during operation.

RECORDS: When service is required, a record should be made of all necessary repairs and replacements. Over a period of time, such records can become a valuable tool for predicting and preventing future maintenance problems and unscheduled downtime. In addition, accurate records make it possible to identify pumps that are poorly suited to their applications.

TROUBLESHOOTING

Pump will not run or runs slowly.

1. Ensure that the air inlet pressure is at least 0.4 bar (5 psig) above startup pressure and that the differential pressure (the difference between air inlet and liquid discharge pressures) is not less than 0.7 bar (10 psig).
2. Check air inlet filter for debris (see recommended installation).
3. Check for extreme air leakage (blow by) which would indicate worn seals/bores in the air valve, pilot spool, main shaft.
4. Disassemble pump and check for obstructions in the air passageways or objects which would obstruct the movement of internal parts.
5. Check for sticking ball check valves. If material being pumped is not compatible with pump elastomers, swelling may occur. Replace ball check valves and seals with proper elastomers. Also, as the check valve balls wear out, they become smaller and can become stuck in the seats. In this case, replace balls and seats.
6. Check for broken inner piston which will cause the air valve spool to be unable to shift.
7. Remove plug from pilot spool exhaust.

Pump runs but little or no product flows.

1. Check for pump cavitation; slow pump speed down to allow thick material to flow into liquid chambers.

2. Verify that vacuum required to lift liquid is not greater than the vapor pressure of the material being pumped (cavitation).
3. Check for sticking ball check valves. If material being pumped is not compatible with pump elastomers, swelling may occur. Replace ball check valves and seats with proper elastomers. Also, as the check valve balls wear out, they become smaller and can become stuck in the seats. In this case, replace balls and seats.

Pump air valve freezes.

1. Check for excessive moisture in compressed air. Either install a dryer or hot air generator for compressed air. Alternatively, a coalescing filter may be used to remove the water from the compressed air in some applications.

Air bubbles in pump discharge.

1. Check for ruptured diaphragm.
2. Check tightness of outer pistons (refer to Section 7).
3. Check tightness of fasteners and integrity of o-rings and seals, especially at intake manifold.
4. Ensure pipe connections are airtight.

Product comes out air exhaust.

1. Check for diaphragm rupture.
2. Check tightness of outer pistons to shaft.

PUMP DISASSEMBLY

Tools Required:

- 1/2" Deep Well Socket
- 9/16" Wrench
- 11/16" Deep Well Socket
- Adjustable Wrench

CAUTION: Before any maintenance or repair is attempted, the compressed air line to the pump must be disconnected and all stored air pressure allowed to bleed from the pump and system. Drain the pump by turning it upside down and allowing any fluid to flow into a suitable container. Be aware of any hazardous effects of contact with your process fluid.

NOTE: The model photographed is a PX8 fitted with the standard Ultra-Flex™ elastomers. Your pump and the tools needed for disassembly may differ from the model shown in this example.



Step 1

Before starting disassembly, mark a line from each liquid chamber to its corresponding air chamber to note alignment. This will assist in proper alignment during reassembly. .



Step 2

Using a 1/2" socket, remove: the four nuts that fasten the handles, handle brackets, handles (if equipped) and the two small clamp bands that fasten the discharge manifold to the liquid chambers.



Step 3

Remove the discharge manifold to expose the valve balls and seats. Inspect the ball cage area of the manifold for excessive wear or damage.



Step 4

Remove the discharge valve balls and seats from the liquid chambers and inspect for nicks, chemical attack or abrasive wear. Replace worn parts with genuine Wilden parts for reliable performance.



Step 5

Using a 1/2" deep well socket, remove the two small clamp bands which fasten the inlet manifold to the liquid chambers.

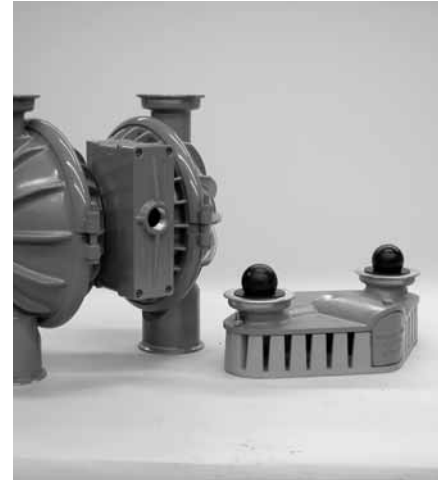

Step 6

Lift the liquid chambers and center section assembly from the inlet manifold to expose the inlet valve balls and seats. Inspect the ball cage area of the liquid chambers for excessive wear or damage.

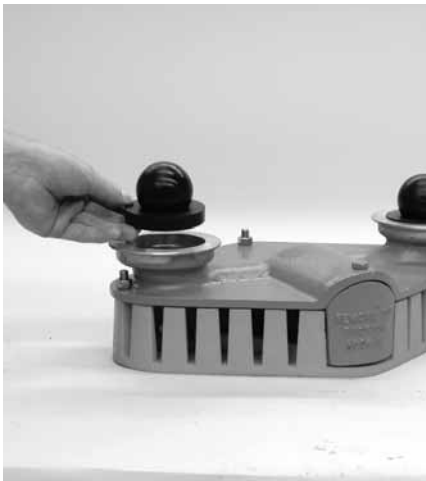

Step 7

Remove the inlet valve balls and seats from the inlet manifold and inspect for nicks, chemical attack or abrasive wear. Replace worn parts with genuine Wilden parts for reliable performance.



Step 8

Using an 11/16" wrench, remove the screen base from the inlet manifold. Using a 9/16" wrench, remove the suction hook up cover from the inlet manifold. Inspect the inlet manifold for cracks or lodged solids in the suction path which may impair performance.



Step 9

Using a 9/16" wrench, remove one of the large clamp bands which secure the liquid chamber to the air chamber and center section assembly.



Step 10

Lift the liquid chamber from the center section assembly exposing the diaphragm and outer piston.



Step 11

By rotating the diaphragm by hand or by using an adjustable wrench remove the diaphragm assembly.

NOTE: Due to varying torque values, one of the following two situations will occur:

- 1) The outer piston, diaphragm, and inner piston remain attached to the shaft and the entire assembly can be removed from the center section assembly.
- 2) The outer piston, diaphragm, and inner piston separate from the shaft which remains fastened to the opposing side. Repeat the disassembly instructions for the remaining side of the pump.



Step 12

Inspect the diaphragm assembly and shaft for wear, damage, or chemical attack. Replace any damaged components with genuine Wilden parts for reliable performance.



Step 13

To remove diaphragm assembly from shaft, secure shaft with soft jaws (aluminum, plastic, or plywood) to ensure the shaft is not damaged. Using an adjustable wrench, remove the diaphragm assembly from the shaft.

AIR VALVE / CENTER SECTION DISASSEMBLY

Tools Required:

- 3/16" Hex (Allen) Wrench
- 1/4" Hex (Allen) Wrench
- External Snap-ring Pliers
- O-Ring Pick

CAUTION: Before any maintenance or repair is attempted, the compressed air line to the pump must be disconnected and all stored air pressure allowed to bleed from the pump and system. Drain the pump by turning it upside down and allowing any fluid to flow into a suitable container. Be aware of any hazardous effects of contact with your process fluid.

NOTE: The Wilden revolutionary Pro-Flo X™ air distribution system (ADS) incorporates all of the advantages of the Pro-Flo V™ ADS (lube-free, non-stalling, etc.) with the added benefit of the efficiency management system (EMS™). Your pump and the tools needed for disassembly may differ from the model shown in this example.

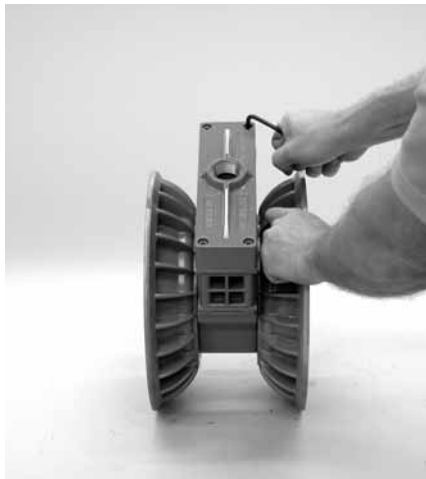

Step 1

Using a 3/16" hex wrench, remove the four bolts retaining the air valve and muffler plate assembly.

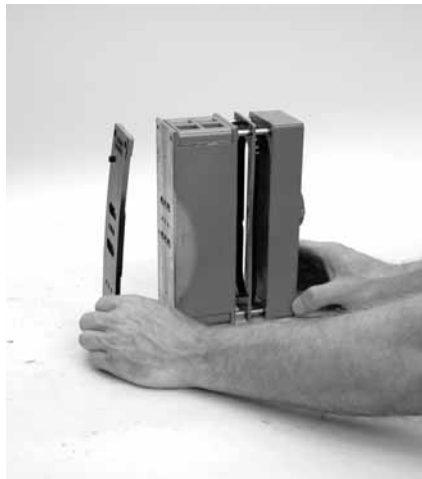

Step 2

Remove and inspect the air valve and muffler plate gaskets. Replace using genuine Wilden parts if necessary.



Step 3

Once the air valve bolts have been removed from the assembly, remove both end caps to expose the air valve spool.

AIR VALVE / CENTER SECTION DISASSEMBLY



Step 4

Gently remove the air valve spool from the bore by pushing on the small end of the valve or pulling the spool using one of the air valve bolts previously removed.

NOTE: Seals should not be removed from the assembly. Seals are not sold separately.



Step 5

Using external snap ring pliers, remove both snap rings retaining the pilot sleeve.



Step 6

Remove the pilot sleeve from the center section by gently taping with a soft mallet or similar.



Step 7

Using an o-ring pick, gently remove the o-ring from the opposite side of the dimpled end of the pilot spool.



Step 8

Gently remove the pilot spool from the sleeve and inspect for nicks, wear, or damage. Replace the pilot spool assembly or sleeve o-rings if necessary. During re-assembly, never insert the dimpled end of the pilot spool first, this will damage the single urethane o-ring by passing it over the ports in the pilot sleeve.

NOTE: Seals should not be removed from the assembly. Seals are not sold separately.



Step 9

Using 1/4" hex wrench, remove the four air chamber bolts per side.

AIR VALVE / CENTER SECTION DISASSEMBLY

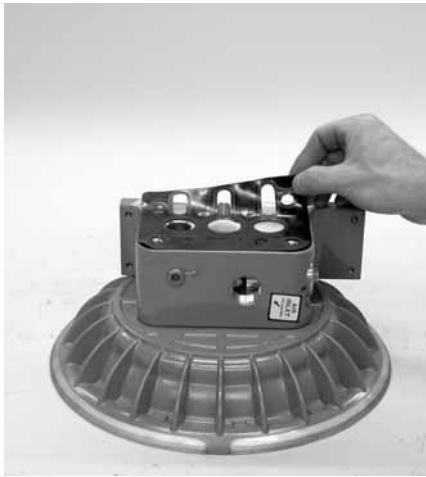

Step 10

Remove the air chamber exposing the air chamber gasket. Replace the gasket(s) if necessary.



Step 11

Remove and inspect the two shaft bushings. Using an o-ring pick, gently remove the two glyd-ring from the center block. Inspect and replace if necessary.

REASSEMBLY HINTS & TIPS

ASSEMBLY:

Upon performing applicable maintenance to the air distribution system, the pump can now be reassembled. Please refer to the disassembly instructions for photos and parts placement. To reassemble the pump, follow the disassembly instructions in reverse order. The air distribution system needs to be assembled first, then the diaphragms and finally the wetted path. Please find the applicable torque specifications on this page. The following tips will assist in the assembly process.

- Lubricate air valve bore, center section shaft and pilot spool bore with NLGI grade 2 white EP bearing grease or equivalent.
- Clean the inside of the center section shaft bore to ensure no damage is done to new shaft seals.
- A small amount NLGI grade 2 white EP bearing grease can be applied to the muffler and air valve gaskets to locate gaskets during assembly.
- Make sure that the exhaust port on the muffler plate is centered between the two exhaust ports on the center section.
- Stainless bolts should be lubed to reduce the possibility of seizing during tightening.
- Use a mallet to tamp lightly on the large clamp bands to seat the diaphragm before tightening.

PRO-FLO X™ MAXIMUM TORQUE SPECIFICATIONS

Description of Part	Torque
Air Valve	13.6 N•m (120 in-lbs)
Air Chamber/Center Block	47.5 N•m (35 ft-lbs)
Outer Pistons, Ultra-Flex™	74.6 N•m (55 ft-lbs)
Small Clamp Bands	6.6 N•m (58 in-lbs)
Large Clamp Bands (Rubber-Fitted)	47.5 N•m (35 ft-lbs)

Figure A

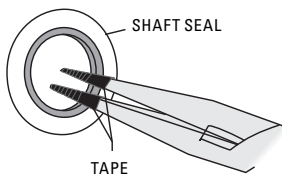

SHAFT SEAL INSTALLATION:

PRE-INSTALLATION

- Once all of the old seals have been removed, the inside of the bushing should be cleaned to ensure no debris is left that may cause premature damage to the new seals.

INSTALLATION

The following tools can be used to aid in the installation of the new seals:

Needle Nose Pliers
Phillips Screwdriver
Electrical Tape

- Wrap electrical tape around each leg of the needle nose pliers (heat shrink tubing may also be used). This is done to prevent damaging the inside surface of the new seal.
- With a new seal in hand, place the two legs of the needle nose pliers inside the seal ring. (See Figure A.)
- Open the pliers as wide as the seal diameter will allow, then with two fingers pull down on the top portion of the seal to form kidney bean shape. (See Figure B.)
- Lightly clamp the pliers together to hold the seal into the kidney shape. Be sure to pull the seal into as tight of a kidney shape as possible, this will allow the seal to travel down the bushing bore easier.
- With the seal clamped in the pliers, insert the seal into the bushing bore and position the bottom of the seal into the correct groove. Once the bottom of the seal is seated in the groove, release the clamp pressure on the pliers. This will allow the seal to partially snap back to its original shape.
- After the pliers are removed, you will notice a slight bump in the seal shape. Before the seal can be properly resized, the bump in the seal should be removed as much as possible. This can be done with either the Phillips screwdriver or your finger. With either the side of the screwdriver or your finger, apply light pressure to the peak of the bump. This pressure will cause the bump to be almost completely eliminated.
- Lubricate the edge of the shaft with NLGI grade 2 white EP bearing grease.
- Slowly insert the center shaft with a rotating motion. This will complete the resizing of the seal.
- Perform these steps for the remaining seals.

Figure B

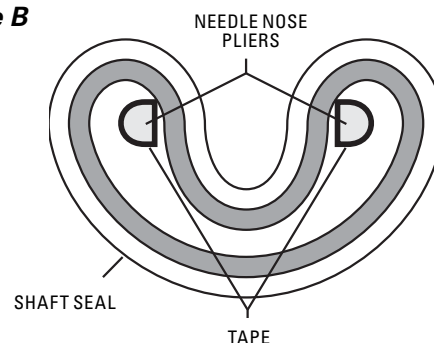



EXPLODED VIEW & PARTS LISTING

PX4 STALLION

Ultra-Flex™-Fitted

EXPLODED VIEW

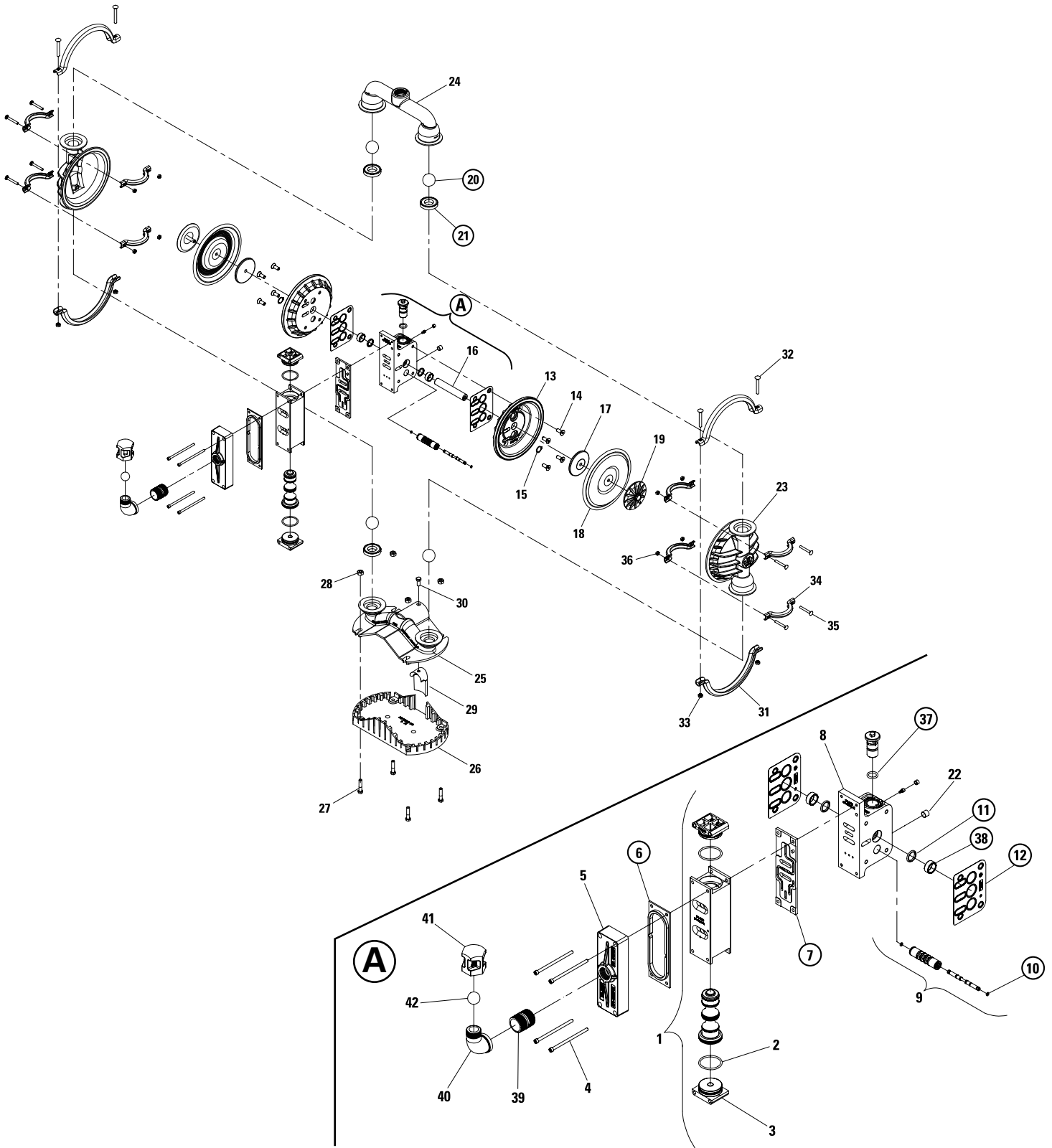

ALL CIRCLED PART IDENTIFIERS ARE INCLUDED IN REPAIR KITS (see section 9).

PX4 STALLION

Ultra-Flex™ - Fitted

PARTS LISTING

Item	Description	Qty.	PX4/AAAAR P/N	PX4/WWWAR P/N
1	Pro-Flo V™ Assembly, Air Valve ¹	1	04-2030-11	04-2030-11
2	O-Ring (-225), End Cap (Ø1.859 x Ø.139)	2	04-2390-52-700	04-2390-52-700
3	End Cap	2	04-2340-01	04-2340-01
4	Screw, SHC, Air Valve (1/4" -20 x 4-1/2")	4	01-6000-03	01-6000-03
5	Muffler Plate, Pro-Flo V™	1	04-3185-01	04-3185-01
6	Gasket, Muffler Plate, Pro-Flo V™	1	04-3502-52	04-3502-52
7	Gasket, Air Valve, Pro-Flo V™	1	04-2621-52	04-2621-52
8	Center Block Assembly, Pro-Flo X™ ²	1	08-3126-01	08-3126-01
9	Pilot Sleeve Assembly	1	04-3880-99F	04-3880-99F
10	Pilot Spool Retaining O-Ring	2	04-2650-49-700	04-2650-49-700
11	Shaft Seal	2	08-3210-55-225	08-3210-55-225
12	Gasket, Center Block Pro-Flo V™	2	04-3529-52	04-3529-52
13	Air Chamber, Pro-Flo V™	2	04-3660-01	04-3660-02
14	Screw, HSFHS (3/8" -16 x 1")	8	71-6250-08	71-6250-08
15	Retaining Ring	2	04-3890-03	04-3890-03
16	Shaft	1	04-3830-03-700	04-3830-03-700
17	Piston Inner, Ultra-Flex™	2	04-3760-01-700	04-3760-01-700
18	Diaphragm	2	*	*
19	Piston Outer, Ultra-Flex™	2	04-4560-01	04-4560-02
20	Ball, Valve	4	*	*
21	Seat, Valve	4	*	*
22	Plug	1	00-7010-08	00-7010-08
23	Liquid Chamber	2	04-5000-01	04-5000-02
24	Manifold, Discharge, NPT (0050)	1	04-5020-01	04-5020-02
	Manifold, Discharge, BSPT (0051)	1	04-5020-01-14	04-5020-02-14
25	Manifold, Inlet, NPT (0050)	1	04-5080-01	04-5080-02-50
	Manifold, Inlet, BSPT (0051)	1	04-5080-01-14	04-5080-02-51
26	Screen, Stallion	1	04-5620-62	04-5620-62
27	Screw, HHC (3/8" -16 x 1 3/4")	4	04-6181-03	04-6181-03
28	Hex Nut (3/8" -16)	4	08-6450-03	08-6450-03
29	Suction Cover	1	04-5660-01	04-5660-01
30	Screw, HHC (3/8" -16 x 7/8")	1	08-6140-03	08-6140-03
31	Large Clamp Band Assembly	2	04-7300-08	04-7300-08
32	Bolt, RHSN (5/16" -18 x 2 1/2")	4	04-6070-08	04-6070-08
33	Hex Nut (5/16" -18)	4	04-6420-08	04-6420-08
34	Small Clamp Band Assembly	4	04-7100-08	04-7100-08
35	Bolt, RHSN (1/4" -20 x 2")	8	04-6050-08	04-6050-08
36	Hex Nut (1/4" -20)	8	04-6400-08	04-6400-08
37	O-Ring (-210), Adjuster (Ø.734" x Ø.139")	1	02-3200-52	02-3200-52
38	Bushing, Shaft	2	08-3306-13	08-3306-13
39	Pipe Nipple	1	15-7420-08	15-7420-08
40	Elbow, 1" NPT x 90°	1	15-3252-08	15-3252-08
41	Check Body	1	15-3550-01	15-3550-01
42	Check Ball	1	15-1450-51	15-1450-51
43	Threaded Stud 3/8 - 16 x 1.5 (Not Shown)	2	N/A	04-6152-08

*See elastomer chart - Section 9

¹Air Valve Assembly includes items 2 and 3.

²Center Block Assembly includes item 11, 22, 37 and 38.

All boldface items are primary wear parts.

EXPLODED VIEW & PARTS LISTING

PX8 STALLION

Ultra-Flex™ - Fitted

EXPLODED VIEW

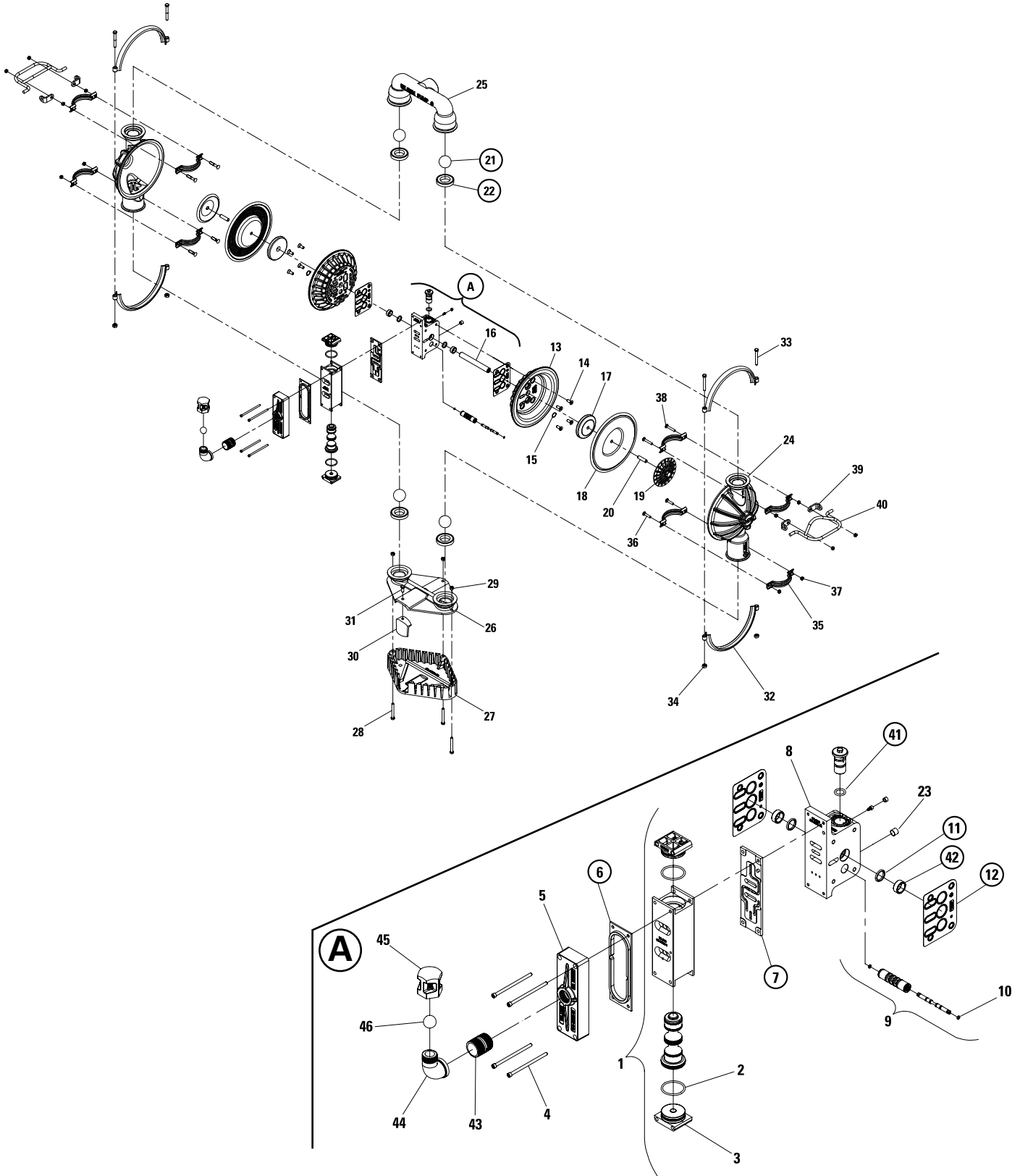

ALL CIRCLED PART IDENTIFIERS ARE INCLUDED IN REPAIR KITS (see section 9).

PX8 STALLION Ultra-Flex™ - Fitted

PARTS LISTING

Item	Description	Qty.	PX8/AAAAR P/N	PX8/WWWAR P/N
1	Pro-Flo V™ Assembly, Air Valve ¹	1	04-2030-11	04-2030-11
2	O-Ring (-225), End Cap (Ø1.859 x Ø.139)	2	04-2390-52-700	04-2390-52-700
3	End Cap	2	04-2340-01	04-2340-01
4	Screw, SHC, Air Valve (1/4" -20 x 4-1/2")	4	01-6000-03	01-6000-03
5	Muffler Plate, Pro-Flo V™	1	04-3185-01	04-3185-01
6	Gasket, Muffler Plate, Pro-Flo V™	1	04-3502-52	04-3502-52
7	Gasket, Air Valve, Pro-Flo V™	1	04-2621-52	04-2621-52
8	Center Block Assembly, Pro-Flo X™ ²	1	08-3126-01	08-3126-01
9	Pilot Sleeve Assembly	1	04-3880-99F	04-3880-99F
10	Pilot Spool Retaining O-Ring	2	04-2650-49-700	04-2650-49-700
11	Shaft Seal	2	08-3210-55-225	08-3210-55-225
12	Gasket, Center Block Pro-Flo V™	2	04-3529-52	04-3529-52
13	Air Chamber, Pro-Flo V™	2	08-3660-01	08-3660-02
14	Screw, HSFHS (3/8" -16 x 1")	8	71-6250-08	71-6250-08
15	Retaining Ring	2	04-3890-03	04-3890-03
16	Shaft	1	08-3841-03	08-3841-03
17	Piston Inner, Ultra-Flex™	2	08-3761-01	08-3761-01
18	Diaphragm	2	*	*
19	Piston Outer, Ultra-Flex™	2	04-4552-01	08-4560-02
20	Stud, (1/2" -20 x 1 7/8")	2	08-6150-08	08-6150-08
21	Ball, Valve	4	*	*
22	Seat, Valve	4	*	*
23	Plug	1	00-7010-08	00-7010-08
24	Liquid Chamber	2	08-5000-01	08-5000-02
25	Manifold, Discharge, NPT (0050)	1	08-5020-01	08-5020-02
	Manifold, Discharge, BSPT (0051)	1	08-5020-01-14	08-5020-02-14
26	Manifold, Inlet, NPT (0050)	1	08-5080-01-30	08-5080-02-30
	Manifold, Inlet, BSPT (0051)	1	08-5080-01-36	08-5080-02-36
27	Screen, Stallion	1	08-5620-62	08-5620-62
28	Screw, HHC (3/8" -16 x 3")	3	08-6120-03	08-6120-03
29	Hex Nut (3/8" -16)	3	02-6430-03	02-6430-03
30	Suction Cover	1	08-5660-01	08-5660-01
31	Screw, HHC (3/8" -16 x 7/8")	1	08-6140-03	08-6140-03
32	Large Clamp Band Assembly	2	08-7300-08	08-7300-08
33	Screw, HHC (3/8" -16 x 3")	4	08-6120-08	08-6120-08
34	Hex Nut (3/8" -16)	4	08-6450-08	08-6450-08
35	Small Clamp Band Assembly	4	08-7100-08	08-7100-08
36	Bolt, RHSN (5/16" -18 x 1 1/2")	4	08-6050-08	08-6050-08
37	Hex Nut (5/16" -18)	12	04-6420-08	04-6420-08
38	Bolt, RHSN (5/16" -18 x 2")	4	08-6050-08-50	08-6050-08-50
39	Bracket, Handle	4	08-7410-08	08-7410-08
40	Handle	2	08-7250-08	08-7250-08
41	O-Ring (-210), Adjuster (Ø.734" x Ø.139")	1	02-3200-52	02-3200-52
42	Bushing, Shaft	2	08-3306-13	08-3306-13
43	Pipe Nipple	1	15-7420-08	15-7420-08
44	Elbow, 1" NPT x 90°	1	15-3252-08	15-3252-08
45	Check Body	1	15-3550-01	15-3550-01
46	Check Ball	1	15-1450-51	15-1450-51

*See elastomer chart - Section 9

¹Air Valve Assembly includes items 2 and 3.

²Center Block Assembly includes item 11, 23, 41 and 42.

All boldface items are primary wear parts.

EXPLODED VIEW & PARTS LISTING

PX15 STALLION

Ultra-Flex™ - Fitted

EXPLODED VIEW

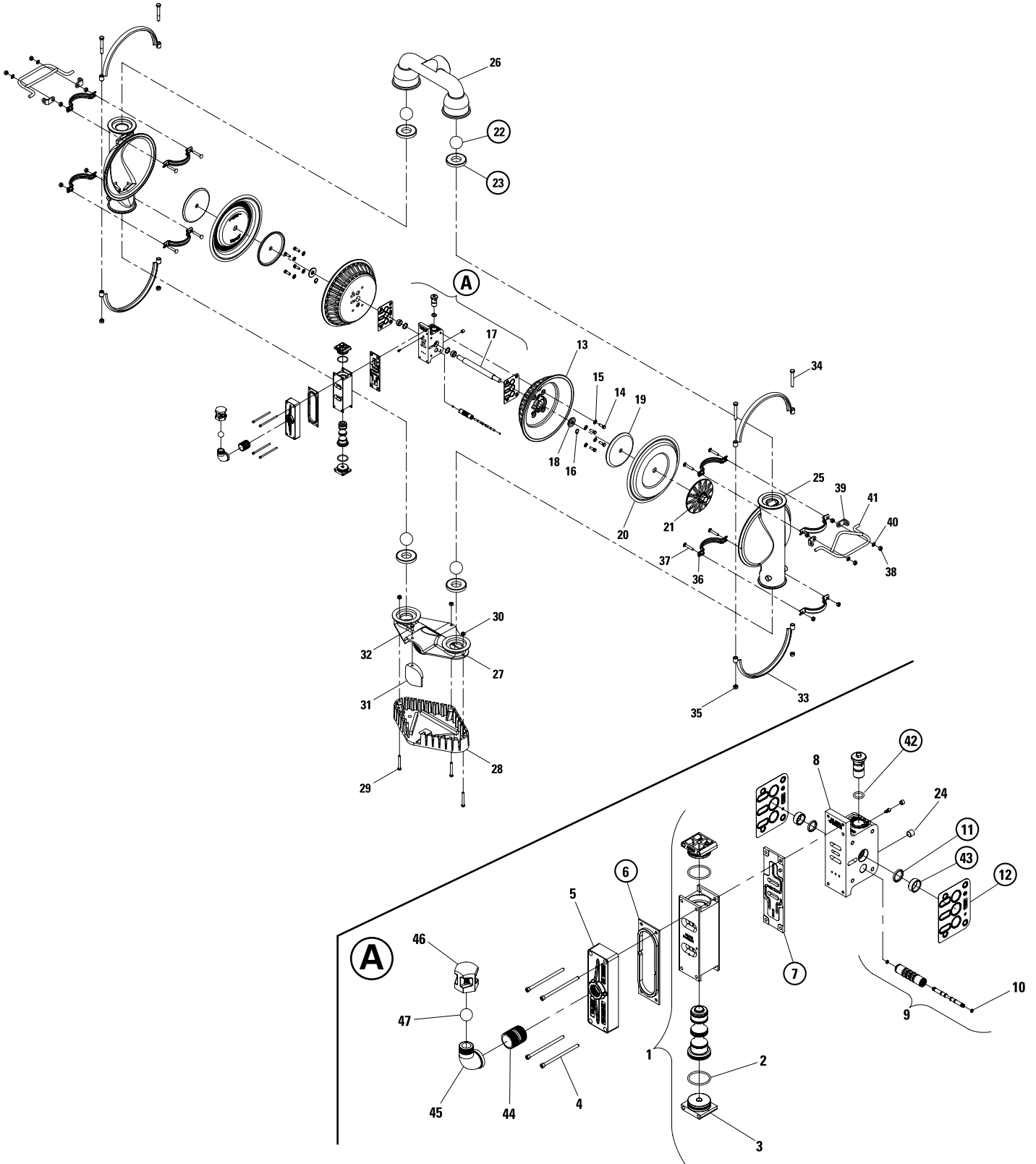

ALL CIRCLED PART IDENTIFIERS ARE INCLUDED IN REPAIR KITS (see section 9).

PX15 STALLION

Ultra-Flex™ - Fitted

PARTS LISTING

Item	Description	Qty.	PX15/AAAAR P/N
1	Pro-Flo V™ Assembly, Air Valve ¹	1	04-2030-11
2	O-Ring (-225), End Cap (Ø1.859 x Ø.139)	2	04-2390-52-700
3	End Cap	2	04-2340-01
4	Screw, SHC, Air Valve (1/4"-20 x 4-1/2")	4	01-6000-03
5	Muffler Plate, Pro-Flo V™	1	04-3185-01
6	Gasket, Muffler Plate, Pro-Flo V™	1	04-3502-52
7	Gasket, Air Valve, Pro-Flo V™	1	04-2621-52
8	Center Block Assembly, Pro-Flo X™ ²	1	15-3126-01
9	Pilot Sleeve Assembly	1	15-3884-99F
10	Pilot Spool Retaining O-Ring	2	04-2650-49-700
11	Shaft Seal	2	15-3210-55-225
12	Gasket, Center Block Pro-Flo V™	2	04-3529-52
13	Air Chamber, Pro-Flo V™	2	15-3660-01
14	Screw, HHC (3/8"-16 x 1 1/8")	8	15-6130-08
15	Washer, Flat (3/8")	8	15-6740-08-50
16	Retaining Ring	2	04-3890-03
17	Shaft	1	20-3841-09
18	Washer, Shoulder	2	15-6850-08
19	Piston Inner, Ultra-Flex™	2	15-3760-08
20	Diaphragm	2	*
21	Piston Outer, Ultra-Flex™	2	15-4560-01
22	Ball, Valve	4	*
23	Seat, Valve	4	*
24	Plug	1	00-7010-08
25	Liquid Chamber	2	15-5000-01
26	Manifold, Discharge, NPT (0050)	1	15-5020-01
	Manifold, Discharge, BSPT (0051)	1	15-5020-01-14
27	Manifold, Inlet, NPT (0050)	1	15-5080-01-30
	Manifold, Inlet, BSPT (0051)	1	15-5080-01-36
28	Screen, Stallion	1	15-5620-62
29	Screw, HHC (3/8"-16 x 3")	3	08-6120-03
30	Hex Nut (3/8"-16)	3	08-6450-03
31	Suction Cover	1	15-5660-01
32	Screw, HHC (3/8"-16 x 7/8")	1	08-6140-03
33	Large Clamp Band Assembly	2	15-7300-08
34	Screw, HHC (1/2"-13 x 3 1/2")	4	15-6120-08
35	Hex Nut (1/2"-13)	4	15-6420-08
36	Small Clamp Band Assembly	4	15-7100-08
37	Bolt, RHSN (3/8"-16 x 2 1/4")	8	15-6050-08
38	Hex Nut (3/8"-16)	12	08-6450-08
39	Bracket, Handle	4	15-7410-08
40	Washer, Flat (3/8")	4	15-6740-08-50
41	Handle	2	15-7250-08
42	O-Ring (-210), Adjuster (Ø.734" x Ø.139")	1	02-3200-52
43	Bushing, Shaft	2	15-3306-13
44	Pipe Nipple	1	15-7420-08
45	Elbow, 1" NPT x 90°	1	15-3252-08
46	Check Body	1	15-3550-01
47	Check Ball	1	15-1450-51

*See elastomer chart - Section 9

¹Air Valve Assembly includes items 2 and 3.

²Center Block Assembly includes item 11, 24, 42 and 43.

All boldface items are primary wear parts.



ELASTOMER OPTIONS

PX4 STALLION

MATERIAL	DIAPHRAGMS (2) P/N	VALVE BALLS (4) P/N	VALVE SEATS (4) P/N
Neoprene	04-1020-51	04-1080-51-50	04-1120-51-50
Buna-N	04-1020-52	04-1080-52-50	04-1120-52-50
Viton®	04-1020-53	04-1080-53-50	04-1120-53-50
EPDM	04-1020-54	04-1080-54-50	04-1120-54-50

PX8 STALLION

MATERIAL	DIAPHRAGMS (2)	VALVE BALLS (4)	VALVE SEATS (4)
	P/N	P/N	P/N
Neoprene	08-1020-51	08-1080-51-50	08-1120-51-50
Buna-N	08-1020-52	08-1080-52-50	08-1120-52-50
Viton®	08-1020-53	08-1080-53-50	08-1120-53-50
EPDM	08-1020-54	08-1080-54-50	08-1120-54-50

PX15 STALLION

MATERIAL	DIAPHRAGMS (2)	VALVE BALLS (4)	VALVE SEATS (4)
	P/N	P/N	P/N
Neoprene	15-1020-51	08-1080-51	15-1120-51-50
Buna-N	15-1020-52	08-1080-52	15-1120-52-50
Viton®	15-1020-53	08-1080-53	15-1120-53-50
EPDM	15-1020-54	08-1080-54	15-1120-54-50



THE EQUALIZER™

WILDEN AUTOMATIC SURGE DAMPENER

A compressed air line attached to the air regulator body sets and maintains pressure on the air side of the diaphragm. As a reciprocating pump begins its stroke, liquid discharge pressure increases which flexes the Equalizer® diaphragm inward (toward the air side). This action accumulates fluid in the liquid chamber (*phase 1*). When the pump redirects its motion upon stroke completion, the liquid discharge pressure decreases allowing the Equalizer® diaphragm to flex outward displacing the fluid into the discharge line (*phase 2*). This motion provides the supplementary pumping action needed to minimize pressure fluctuation.

Phase 1

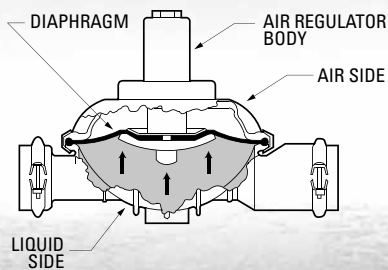

Phase 2

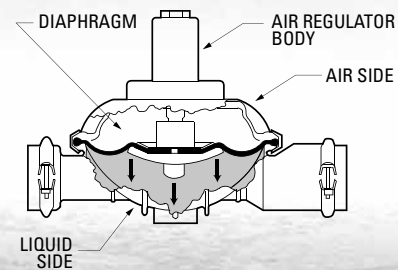

WILDEN®

A DOVER COMPANY

22069 VAN BUREN STREET • GRAND TERRACE, CA 92313-5607
(909) 422-1730 • FAX (909) 783-3440
www.wildenpump.com

Your Solutions Wrapped Up



E L A S T O M E R K I T S

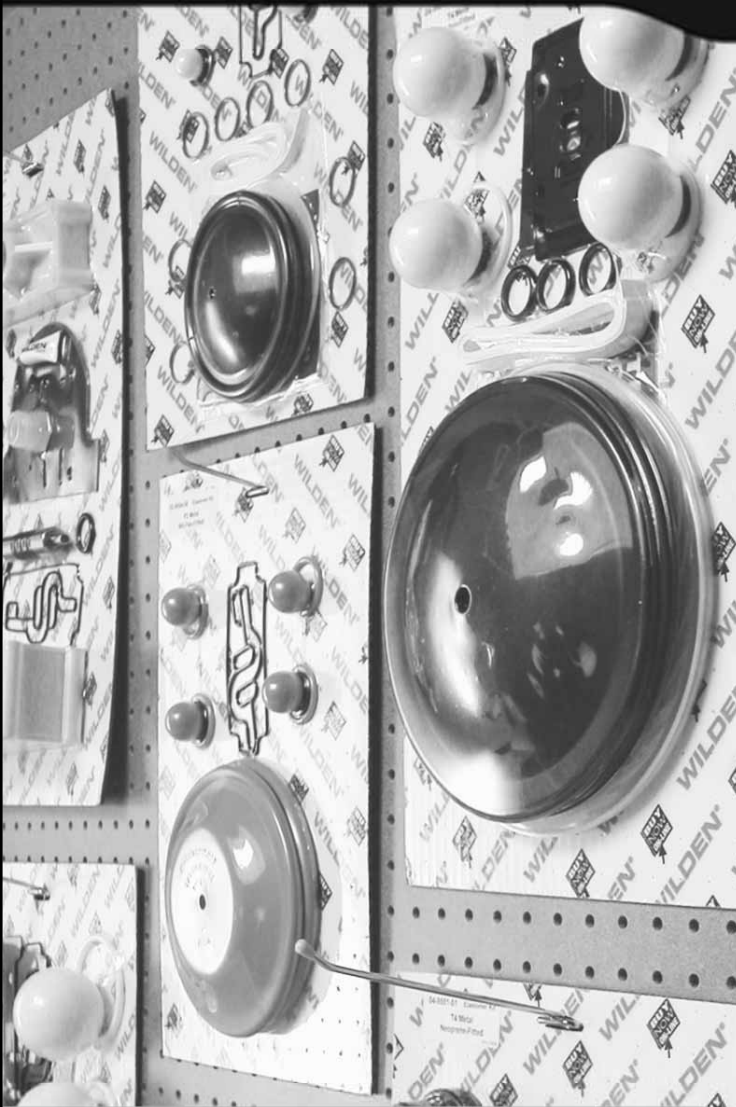

Program Details:

- Elastomer & ADS Repair Kits
- All Sizes Available
- PTFE, Rubber & TPE Elastomers
- One Part Number Simplifies Inventory
- Eliminates Order Errors
- Reduces Re-Build Time
- Rejuvenates Your Pump

NOTE: See Section 9.

WILDEN[®]
A DOVER COMPANY

22069 VAN BUREN STREET • GRAND TERRACE, CA 92313-5607
(909) 422-1730 • FAX (909) 783-3440
www.wildenpump.com

WARRANTY

Each and every product manufactured by Wilden Pump and Engineering, LLC is built to meet the highest standards of quality. Every pump is functionally tested to insure integrity of operation.

Wilden Pump and Engineering, LLC warrants that pumps, accessories and parts manufactured or supplied by it to be free from defects in material and workmanship for a period of five (5) years from date of installation or six (6) years from date of manufacture, whichever comes first. Failure due to normal wear, misapplication, or abuse is, of course, excluded from this warranty.

Since the use of Wilden pumps and parts is beyond our control, we cannot guarantee the suitability of any pump or part for a particular application and Wilden Pump and Engineering, LLC shall not be liable for any consequential damage or expense arising from the use or misuse of its products on any application. Responsibility is limited solely to replacement or repair of defective Wilden pumps and parts.

All decisions as to the cause of failure are the sole determination of Wilden Pump and Engineering, LLC.

Prior approval must be obtained from Wilden for return of any items for warranty consideration and must be accompanied by the appropriate MSDS for the product(s) involved. A Return Goods Tag, obtained from an authorized Wilden distributor, must be included with the items which must be shipped freight prepaid.

The foregoing warranty is exclusive and in lieu of all other warranties expressed or implied (whether written or oral) including all implied warranties of merchantability and fitness for any particular purpose. No distributor or other person is authorized to assume any liability or obligation for Wilden Pump and Engineering, LLC other than expressly provided herein.

PLEASE PRINT OR TYPE AND FAX TO WILDEN

PUMP INFORMATION			
Item # _____		Serial # _____	
Company Where Purchased _____			
YOUR INFORMATION			
Company Name _____			
Industry _____			
Name _____		Title _____	
Street Address _____			
City _____		State _____	Postal Code _____
Country _____			
Telephone _____		Fax _____	Web Address _____
E-mail _____			
Number of pumps in facility? _____		Number of Wilden pumps? _____	
Types of pumps in facility (check all that apply): <input type="checkbox"/> Diaphragm <input type="checkbox"/> Centrifugal <input type="checkbox"/> Gear <input type="checkbox"/> Submersible <input type="checkbox"/> Lobe			
<input type="checkbox"/> Other _____			
Media being pumped? _____			
How did you hear of Wilden Pump? <input type="checkbox"/> Trade Journal <input type="checkbox"/> Trade Show <input type="checkbox"/> Internet/E-mail <input type="checkbox"/> Distributor			
<input type="checkbox"/> Other _____			

ONCE COMPLETE, FAX TO (909) 783-3440

NOTE: WARRANTY VOID IF PAGE IS NOT FAXED TO WILDEN

WILDEN PUMP & ENGINEERING, LLC